

THIS IS A C.A.D. GENERATED DRAWING
DO NOT MAKE MANUAL REVISIONS TO MASTER.

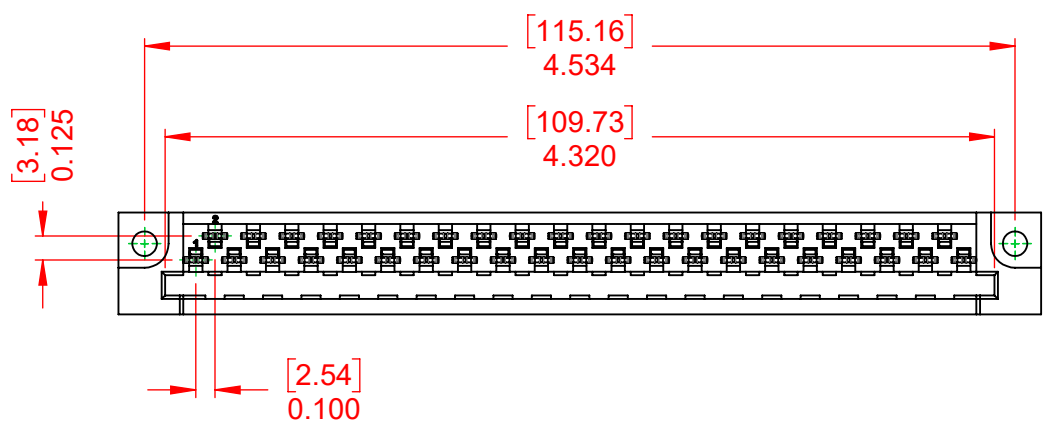

ISSUE NUMBER	
ORIGINAL	①

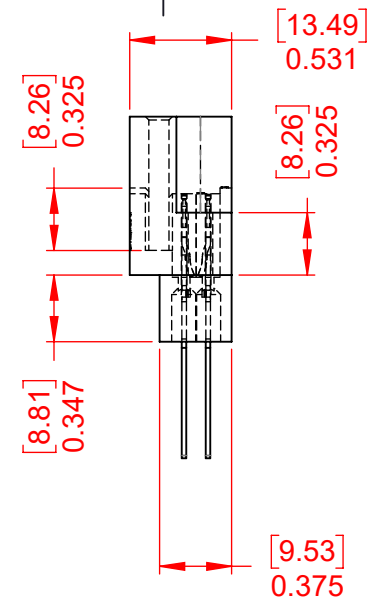
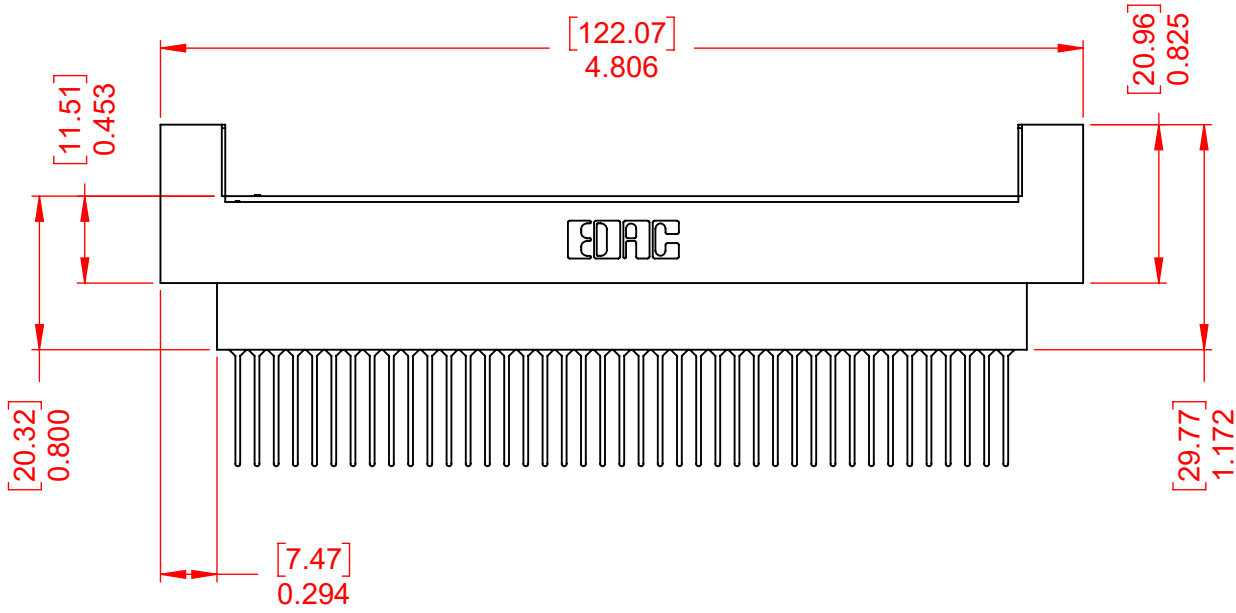

NOTES:

- MATERIAL:**
HOUSING: DIALLYL PTHYHALATE, UL94V-0
CONTACT MATERIAL: COPPER ALLOY
CONTACT PLATING: GOLD PLATING OVER NICKEL
INSERTION FORCE: 6 TO 16 Oz (0.56 TO 4.45N) PER CONTACT
WITHDRAWAL FORCE: 6 TO 16 Oz (0.56 TO 4.45N) PER CONTACT
- OPERATING TEMPERATURE:** -65°C ~ 125°C
- CURRENT RATING:** 10A PER CONTACT
CONTACT RESISTANCE: 10mΩ MAX.
INSULATOR RESISTANCE: 5000MΩ min.
DIELECTRIC WITHSTANDING VOLTAGE: 2000V AC rms AT SEA LEVEL
- CONTACT TYPE:**
 541-Wire Wrap .026x.024(0.66x0.61) - Tail LG.=.620(15.75)

415 & 438 SERIES CARD EDGE		SW REFERENCE NO.: 415 ASSEMBLY	
		DRAWN: W.T	DATE: AUG. 01/2018
EDAC EDAC INC TORONTO, ONTARIO CANADA YOUR CONNECTION TO QUALITY & SERVICE		CHECKED:	DATE:
		SCALE: 1:1	SHEET 1 OF 1
THESE DRAWINGS AND SPECIFICATIONS ARE THE PROPERTY OF EDAC INC., AND SHALL NOT BE REPRODUCED, OR COPIED OR USED AS THE BASIS FOR THE MANUFACTURE OR SALE OF APPARATUS WITHOUT WRITTEN PERMISSION.			DRAWING NUMBER: 415-041-541-222
			PART NUMBER: 415-041-541-222
			ISSUE 1



THIS SERIES FULLY CONFORMS TO THE EUROPEAN UNION DIRECTIVES 2011/65/EU FOR RoHS COMPLIANCY.