

# Interstate 75 (HUB75 LED Matrix Driver), PIM584

USB-C connector

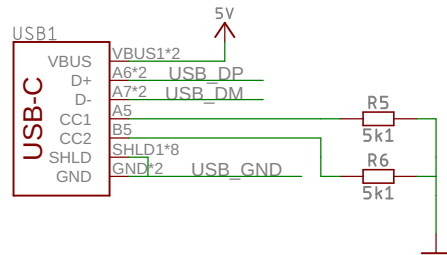

RGB LED

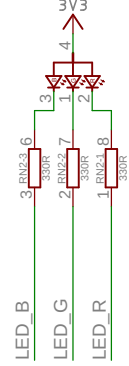

RP2040 MCU

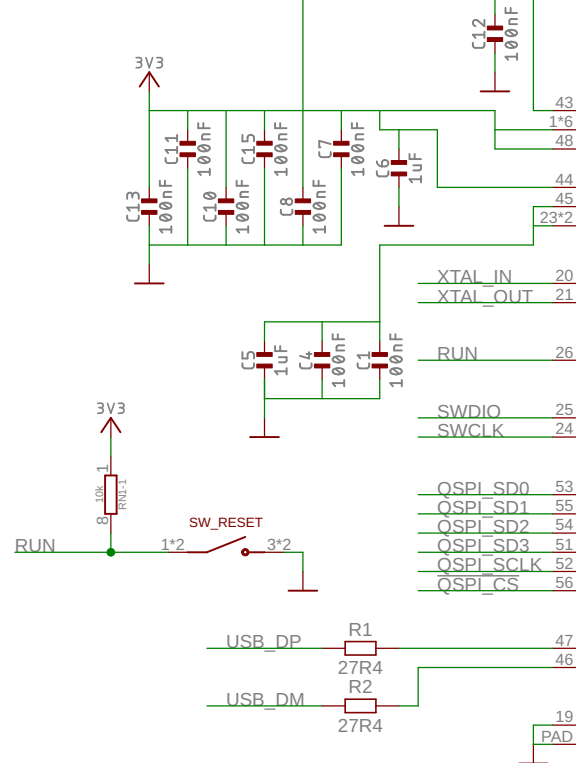

MCU1

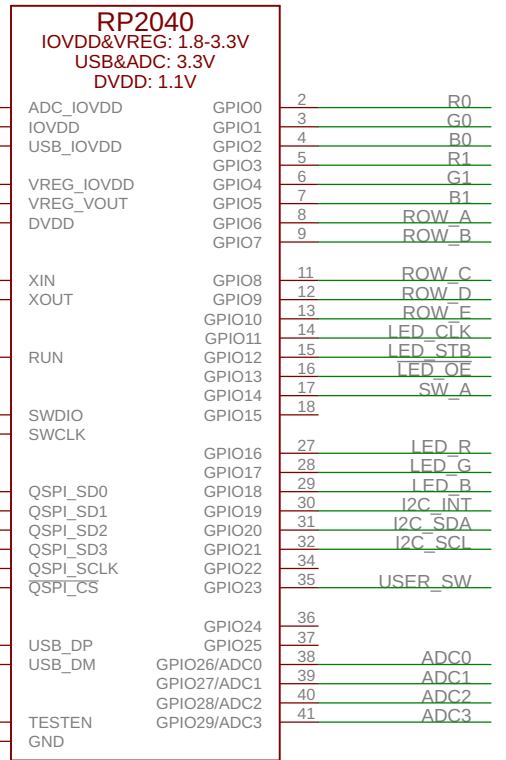

LDO

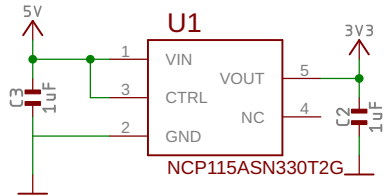

Qwiic / Stemma QT connector

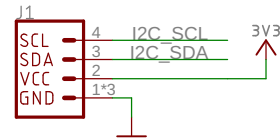

User switch

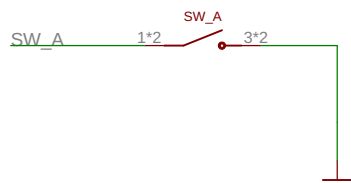

Crystal oscillator

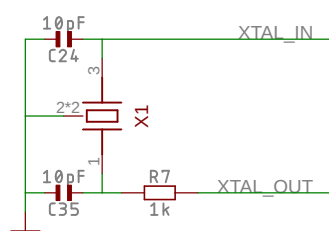

Flash memory

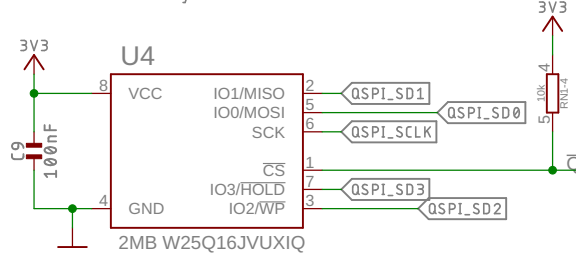

Combined USB boot & user switch

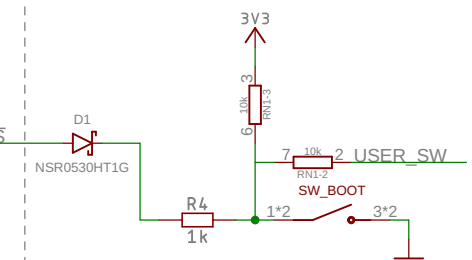

# Interstate 75 (HUB75 LED Matrix Driver), PIM584

## Expansion header

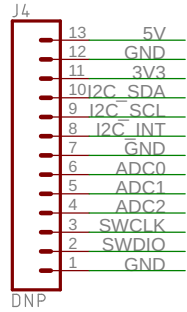

## LED Matrix header (top view of driver side connector)

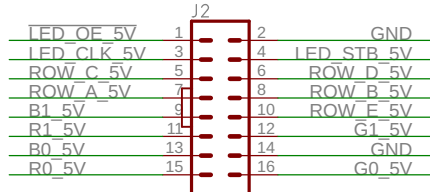

## Current sense amplifier

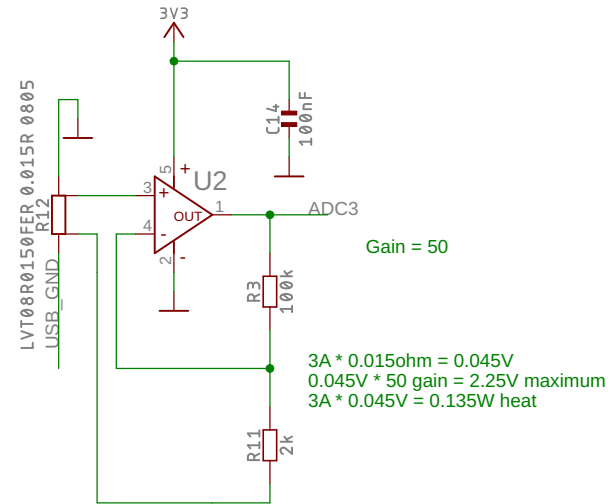

## 5V screw terminals

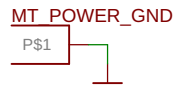
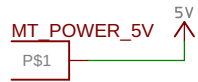

## 5V level shifters

