

Data sheet | Item number: 2102-1304

3-conductor through terminal block; with lever and Push-in CAGE CLAMP®; 2.5 mm²; with test port; suitable for Ex i applications; side and center marking; for DIN-rail 35 x 15 and 35 x 7.5; Push-in CAGE CLAMP®; 2,50 mm²; blue

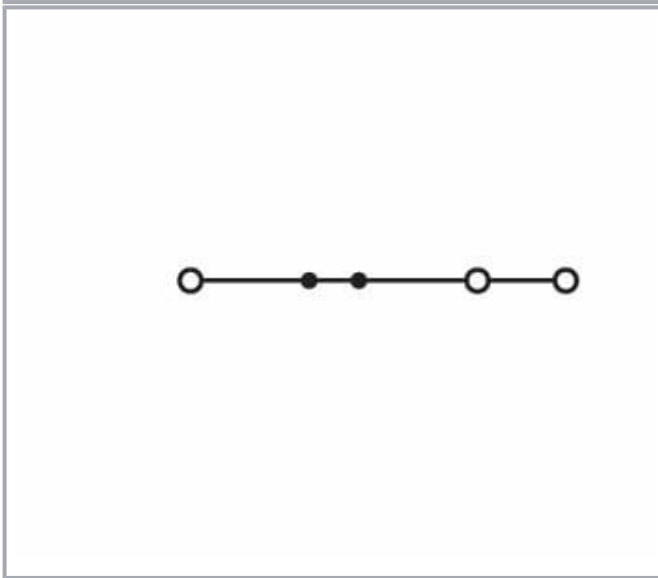

www.wago.com/2102-1304

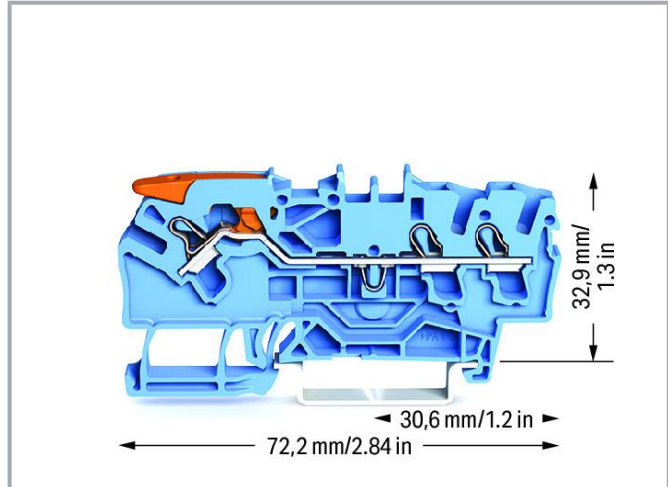
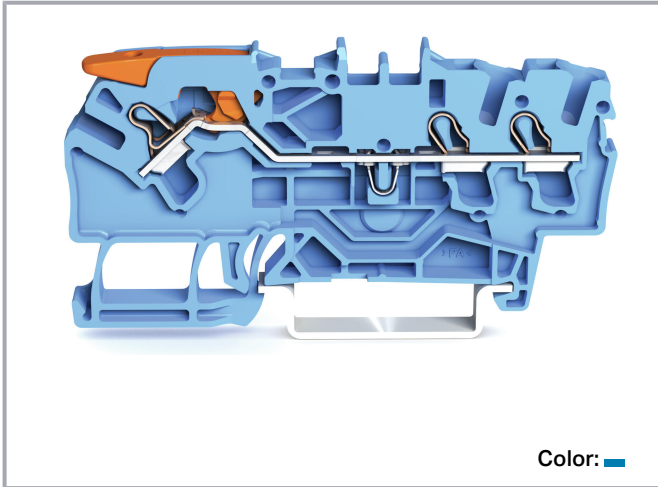

Data

Electrical data

Ratings per IEC/EN

Ratings per	IEC/EN 60947-7-1
Nominal voltage (III/3)	800 V

Subject to changes. Please also observe the further product documentation!

WAGO GmbH & Co. KG
Hansastr. 27
32423 Minden
Phone: +49571 887-0 | Fax: +49571 887-169
Email: info.de@wago.com | Web: www.wago.com

Do you have any questions about our products?
We are always happy to take your call at +49 (571) 887-44222.



Rated impulse voltage (III/3)	8 kV
Rated current	24 A
Current at conductor cross-section (max.) mm ²	30 A
Legend (ratings)	(III / 3) \triangleq Overvoltage category III / Pollution degree 3

Ratings per UL 1059

Approvals per	UL 1059
Rated voltage UL (Use Group B)	600 V
Rated current UL (Use Group B)	20 A
Rated voltage UL (Use Group C)	600 V
Rated current UL (Use Group C)	20 A

Ratings per CSA

Approvals per	CSA 22.2 No 158
Rated voltage CSA (Use Group B)	600 V
Rated current CSA (Use Group B)	20 A
Rated voltage CSA (Use Group C)	600 V
Rated current CSA (Use Group C)	20 A

Ex information

Reference hazardous areas	See "Downloads – Documentation – Additional Information: Technical Section; Technical Explications"
Ratings per	ATEX: PTB 18 ATEX 1010 U / IECEx: PTB 18.0001U (Ex eb IIC Gb)
Rated voltage EN (Ex e II)	550 V
Rated current (Ex e II)	23.5 A
Rated current (Ex e II) with jumper	20 A

Power loss

Power loss, per pole (potential)	0.766 W
Rated current I_N for specified power loss	24 A
Resistance value for specified, current-dependent power loss	0.001 Ω

Connection data

Connection points	3
Total number of potentials	1
Number of levels	1

Subject to changes. Please also observe the further product documentation!



Number of jumper slots	2
------------------------	---

Connection 1

Connection technology	Push-in CAGE CLAMP®
Actuation type	Lever
Connectable conductor materials	Copper
Nominal cross-section	2.5 mm ²
Solid conductor	0.25 ... 4 mm ² / 22 ... 12 AWG
Solid conductor; push-in termination	0.75 ... 4 mm ² / 18 ... 12 AWG
Fine-stranded conductor	0.25 ... 4 mm ² / 22 ... 12 AWG
Fine-stranded conductor; with insulated ferrule	0.25 ... 2.5 mm ² / 22 ... 14 AWG
Fine-stranded conductor; with ferrule; push-in termination	1 ... 2.5 mm ² / 18 ... 14 AWG
Note (conductor cross-section)	Depending on the conductor characteristic, a conductor with a smaller cross-section can also be inserted via push-in termination.
Strip length	10 ... 12 mm / 0.39 ... 0.47 inches
Wiring direction	Front-entry wiring

Connection 2

Actuation type 2	Operating tool
------------------	----------------

Physical data

Width	5.2 mm / 0.205 inches
Height	72.2 mm / 2.843 inches
Depth from upper-edge of DIN-rail	32.9 mm / 1.295 inches

Mechanical Data

Mounting type	DIN-35 rail
Marking level	Center/side marking

Material Data

Note (material data)	Information on material specifications can be found here
Color	blue
Material group	I
Insulation material	Polyamide (PA66)

Subject to changes. Please also observe the further product documentation!

Flammability class per UL94	V0
Fire load	0.173 MJ
Weight	8 g

Environmental requirements

Processing temperature	-35 ... +85 °C
Continuous operating temperature	-60 ... +105 °C

Commercial data



eCl@ss 10.0	27-14-11-20
eCl@ss 9.0	27-14-11-20
ETIM 8.0	EC000897
ETIM 7.0	EC000897
PU (SPU)	50 pcs
Packaging type	box
Country of origin	DE
GTIN	4055143741804
Customs tariff number	85369010000

Environmental Product Compliance

RoHS Compliance Status	Compliant, No Exemption
------------------------	-------------------------

Approvals / Certificates

General approvals

Logo	Approval	Additional Approval Text	Certificate name
	CCA DEKRA Certification B.V.	EN 60947	NTR NL 7670
	CCC CNEX	GB/T 3836.3	2020312313000163 (Ex eb IIC Gb, Ex eb I Mb)
	CSA DEKRA Certification B.V.	C22.2	70175030
	cURus	UL 1059	E45172

Subject to changes. Please also observe the further product documentation!

Underwriters Laboratories Inc.





KEMA/KEUR
DEKRA Certification B.V.





EN 60947

71-102882

Declarations of conformity and manufacturer's declarations

Logo	Approval	Additional Approval Text	Certificate name
	EU-Declaration of Conformity WAGO GmbH & Co. KG	-	-
	UK-Declaration of Conformity WAGO GmbH & Co. KG	-	-

Approvals for marine applications

Logo	Approval	Additional Approval Text	Certificate name
	ABS American Bureau of Shipping	-	19- HG1866350- PDA
	BV Bureau Veritas S.A.	IEC 60947	58186/A0 BV
	DNV GL Det Norske Veritas, Germanischer Lloyd	-	TAE00003JT
	LR Lloyds Register	-	19/20050

Approvals for hazardous areas

Logo	Approval	Additional Approval Text	Certificate name
	AEx	UL 60079	20181105-E185892

Subject to changes. Please also observe the further product documentation!

WAGO GmbH & Co. KG
Hansastr. 27
32423 Minden
Phone: +49571 887-0 | Fax: +49571 887-169
Email: info.de@wago.com | Web: www.wago.com

Do you have any questions about our products?
We are always happy to take your call at +49 (571) 887-44222.

Underwriters Laboratories Inc.





(AEx eb IIC resp. Ex eb IIC)

	ATEX Physikalisch Technische Bundesanstalt	EN 60079-0	PTB 18 ATEX 1010 U (II 2 G Ex eb IIC Gb bzw. I M 2 Ex eb I Mb)
	CCC CNEX	GB/T 3836.3	2020312313000163 (Ex eb IIC Gb, Ex eb I Mb)
	EAC Brjansker Zertifizierungsstelle	TP TC 012/2011	RU C-DE.AM02.B. 00127/19 (Ex e IIC Gb U)
	IECEX Physikalisch Technische Bundesanstalt	IEC 60079-0	IECEX PTB 18.0017U (Ex eb IIC Gb resp. Ex eb I Mb)
	INMETRO TÜV Rheinland do Brasil Ltda.	IEC 60079	TÜV 19.0818 U

Required accessories

End plate

End plate

	Item no.: 2102-1391 End and intermediate plate; 0.8 mm thick; for 3-conductor terminal blocks; gray	www.wago.com/2102-1391
	Item no.: 2102-1392 End and intermediate plate; 0.8 mm thick; for 3-conductor terminal blocks; orange	www.wago.com/2102-1392

Optional accessories

Insulation stop

Insulation stop

	Item no.: 2002-171 Insulation stop; 0.25 - 0.5 mm ² ; 5 pieces/strip; light gray	www.wago.com/2002-171
--	---	--

Subject to changes. Please also observe the further product documentation!



Item no.: 2002-172
Insulation stop; 0.75 - 1 mm²; 5 pieces/strip; dark gray

Carrier rail

Mounting accessories



Item no.: 210-197
Steel carrier rail; 35 x 15 mm; 1.5 mm thick; 2 m long; slotted; similar to EN 60715; silver-colored

www.wago.com/210-197



Item no.: 210-198
Copper carrier rail; 35 x 15 mm; 2.3 mm thick; 2 m long; unslotted; according to EN 60715; copper-colored

www.wago.com/210-198



Item no.: 210-113
Steel carrier rail; 35 x 7.5 mm; 1 mm thick; 2 m long; unslotted; according to EN 60715; silver-colored

www.wago.com/210-113

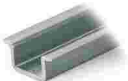

Item no.: 210-118
Steel carrier rail; 35 x 15 mm; 2.3 mm thick; 2 m long; unslotted; according to EN 60715; silver-colored

www.wago.com/210-118



Item no.: 210-112
Steel carrier rail; 35 x 7.5 mm; 1 mm thick; 2 m long; slotted; according to EN 60715; "Hole width 25 mm; silver-colored

www.wago.com/210-112



Item no.: 210-114
Steel carrier rail; 35 x 15 mm; 1.5 mm thick; 2 m long; unslotted; similar to EN 60715; silver-colored

www.wago.com/210-114



Item no.: 210-115
Steel carrier rail; 35 x 7.5 mm; 1 mm thick; 2 m long; slotted; according to EN 60715; "Hole width 18 mm; silver-colored

www.wago.com/210-115

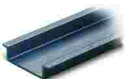

Item no.: 210-196
Aluminum carrier rail; 35 x 8.2 mm; 1.6 mm thick; 2 m long; unslotted; similar to EN 60715; silver-colored

www.wago.com/210-196

Mounting

Cover carrier



Item no.: 709-169
Cover carrier; Type 3; gray

www.wago.com/709-169

Cover



Item no.: 709-156
Cover; Type 3; suitable for cover carrier, type 3; 1 m long; transparent

www.wago.com/709-156

Tool

Operating tool



Item no.: 210-658
Operating tool; Blade: 3.5 x 0.5 mm; with a partially insulated shaft; angled; short; multicoloured

www.wago.com/210-658

Subject to changes. Please also observe the further product documentation!



Item no.: 210-720

Operating tool; Blade: 3.5 x 0.5 mm; with a partially insulated shaft; multicoloured

www.wago.com/210-720

Plugs

Diode plug



Item no.: 2002-880/1000-411

Component plug; 2-pole; with diode 1N4007; 10.4 mm wide; Operating temperature 85°C max.; gray

www.wago.com/2002-880

/1000-411

LED plug



Item no.: 2002-880/1000-541

Component plug; 2-pole; LED (red); 10.4 mm wide; Operating temperature 85°C max.; gray

www.wago.com/2002-880

/1000-541



Item no.: 2002-880/1000-542

Component plug; 2-pole; LED (red); 10.4 mm wide; Operating temperature 85°C max.; multicoloured

www.wago.com/2002-880

/1000-542



Item no.: 2002-880/1000-836

Component plug; 2-pole; LED (red); 10.4 mm wide; Operating temperature 85°C max.; gray

www.wago.com/2002-880

/1000-836

Empty component plug housing



Item no.: 2002-880

Empty component plug housing; 10.4 mm wide; 2-pole; Type 4; gray

www.wago.com/2002-880

Push-in type wire jumper

Jumper



Item no.: 2009-412

Push-in type wire jumper; insulated; 60 mm long; black

www.wago.com/2009-412



Item no.: 2009-414

Push-in type wire jumper; 1.5 mm²; insulated; 110 mm long; black

www.wago.com/2009-414



Item no.: 2009-416

Push-in type wire jumper; 1.5 mm²; insulated; 250 mm long; black

www.wago.com/2009-416



Item no.: 2009-414/000-005

Push-in type wire jumper; 1.5 mm²; insulated; 110 mm long; black

www.wago.com/2009-414

/000-005



Item no.: 2009-414/000-006

Push-in type wire jumper; insulated; 110 mm long; black

www.wago.com/2009-414

/000-006

Jumpers

Jumper

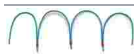

Item no.: 210-123

Wire commoning chain; insulated; blue

www.wago.com/210-123

Subject to changes. Please also observe the further product documentation!

WAGO GmbH & Co. KG

Hansastr. 27















32423 Minden

Phone: +49571 887-0 | Fax: +49571 887-169

Email: info.de@wago.com | Web: www.wago.com

Do you have any questions about our products?

We are always happy to take your call at +49 (571) 887-44222.

	Item no.: 2002-402 Jumper; 2-way; insulated; light gray	www.wago.com/2002-402
	Item no.: 2002-402/000-005 Jumper; 2-way; insulated; red	www.wago.com/2002-402/000-005
	Item no.: 2002-400 Continuous jumper; 2-way; insulated; light gray	www.wago.com/2002-400
	Item no.: 2002-403 Jumper; 3-way; insulated; light gray	www.wago.com/2002-403
	Item no.: 2002-404/000-005 Jumper; 4-way; insulated; red	www.wago.com/2002-404/000-005
	Item no.: 2002-403/000-006 Jumper; 3-way; insulated; blue	www.wago.com/2002-403/000-006
	Item no.: 2002-404/000-006 Jumper; 4-way; insulated; blue	www.wago.com/2002-404/000-006
	Item no.: 2002-403/000-005 Jumper; 3-way; insulated; red	www.wago.com/2002-403/000-005
	Item no.: 2002-405/000-005 Jumper; 5-way; insulated; red	www.wago.com/2002-405/000-005
	Item no.: 2002-402/000-006 Jumper; 2-way; insulated; blue	www.wago.com/2002-402/000-006
	Item no.: 2002-405/000-006 Jumper; 5-way; insulated; blue	www.wago.com/2002-405/000-006
	Item no.: 2002-404 Jumper; 4-way; insulated; light gray	www.wago.com/2002-404
	Item no.: 2002-406/000-006 Jumper; 6-way; insulated; blue	www.wago.com/2002-406/000-006
	Item no.: 2002-406/000-005 Jumper; 6-way; insulated; red	www.wago.com/2002-406/000-005

Subject to changes. Please also observe the further product documentation!



Item no.: 2002-406/020-000
Delta jumper; insulated; light gray

www.wago.com/2002-406/020-000



Item no.: 2002-405
Jumper; 5-way; insulated; light gray

www.wago.com/2002-405



Item no.: 2002-407/000-005
Jumper; 7-way; insulated; red

www.wago.com/2002-407/000-005



Item no.: 2002-408
Jumper; 8-way; insulated; light gray

www.wago.com/2002-408



Item no.: 2002-408/000-006
Jumper; 8-way; insulated; blue

www.wago.com/2002-408/000-006



Item no.: 2002-405/011-000
Star point jumper; 3-way; insulated; light gray

www.wago.com/2002-405/011-000



Item no.: 2002-407/000-006
Jumper; 7-way; insulated; blue

www.wago.com/2002-407/000-006



Item no.: 2002-408/000-005
Jumper; 8-way; insulated; red

www.wago.com/2002-408/000-005



Item no.: 2002-407
Jumper; 7-way; insulated; light gray

www.wago.com/2002-407



Item no.: 2002-406
Jumper; 6-way; insulated; light gray

www.wago.com/2002-406



Item no.: 2002-410/000-005
Jumper; 10-way; insulated; red

















www.wago.com/2002-410/000-005



Item no.: 2002-410/000-006
Jumper; 10-way; insulated; blue

www.wago.com/2002-410/000-006

Subject to changes. Please also observe the further product documentation!

	Item no.: 2002-410 Jumper; 10-way; insulated; light gray	www.wago.com/2002-410
	Item no.: 2002-409/000-006 Jumper; 9-way; insulated; blue	www.wago.com/2002-409/000-006
	Item no.: 2002-409/000-005 Jumper; 9-way; insulated; red	www.wago.com/2002-409/000-005
	Item no.: 2002-409 Jumper; 9-way; insulated; light gray	www.wago.com/2002-409
	Item no.: 2002-423/000-006 Continuous jumper; from 1 to 3; insulated; blue	www.wago.com/2002-423/000-006
	Item no.: 2002-423 Continuous jumper; from 1 to 3; insulated; light gray	www.wago.com/2002-423
	Item no.: 2002-433 Jumper; from 1 to 3; insulated; light gray	www.wago.com/2002-433
	Item no.: 2002-434 Jumper; from 1 to 4; insulated; light gray	www.wago.com/2002-434
	Item no.: 2002-423/000-005 Continuous jumper; from 1 to 3; insulated; red	www.wago.com/2002-423/000-005
	Item no.: 2002-435 Jumper; from 1 to 5; insulated; light gray	www.wago.com/2002-435
	Item no.: 2002-436 Jumper; from 1 to 6; insulated; light gray	www.wago.com/2002-436
	Item no.: 2002-437 Jumper; from 1 to 7; insulated; light gray	www.wago.com/2002-437
	Item no.: 2002-438 Jumper; from 1 to 8; insulated; light gray	www.wago.com/2002-438
	Item no.: 2002-439 Jumper; from 1 to 9; insulated; light gray	www.wago.com/2002-439
	Item no.: 2002-440 Jumper; from 1 to 10; insulated; light gray	www.wago.com/2002-440
	Item no.: 2002-472	www.wago.com/2002-472

Subject to changes. Please also observe the further product documentation!

Staggered jumper; 2-way; insulated; light gray



Item no.: 2002-473

Staggered jumper; 3-way; insulated; light gray

www.wago.com/2002-473



Item no.: 2002-475/011-000

Staggered jumper; 3-way; insulated; light gray

www.wago.com/2002-475/011-000



Item no.: 2002-475

Staggered jumper; 5-way; insulated; light gray

www.wago.com/2002-475



Item no.: 2002-476

Staggered jumper; 6-way; insulated; light gray

www.wago.com/2002-476



Item no.: 2002-474

Staggered jumper; 4-way; insulated; light gray

www.wago.com/2002-474



Item no.: 2002-477

Staggered jumper; 7-way; insulated; light gray

www.wago.com/2002-477



Item no.: 2002-473/011-000

Staggered jumper; 2-way; from 1 to 3; insulated; light gray

www.wago.com/2002-473/011-000



Item no.: 2002-479

Staggered jumper; 9-way; insulated; light gray

www.wago.com/2002-479



Item no.: 2002-478

Staggered jumper; 8-way; insulated; light gray

www.wago.com/2002-478



Item no.: 2002-479/011-000

Staggered jumper; insulated; light gray

www.wago.com/2002-479/011-000



Item no.: 2002-480

Staggered jumper; 10-way; insulated; light gray

www.wago.com/2002-480



Item no.: 2002-477/011-000

Staggered jumper; insulated; light gray

www.wago.com/2002-477/011-000



Item no.: 2002-481/011-000

Staggered jumper; insulated; light gray

www.wago.com/2002-481/011-000



Item no.: 2002-481

Staggered jumper; 11-way; insulated; light gray

www.wago.com/2002-481



Item no.: 2002-482

Staggered jumper; 12-way; insulated; light gray

www.wago.com/2002-482

Subject to changes. Please also observe the further product documentation!

WAGO GmbH & Co. KG

Hansastr. 27

32423 Minden

Phone: +49571 887-0 | Fax: +49571 887-169

Email: info.de@wago.com | Web: www.wago.com

Do you have any questions about our products?

We are always happy to take your call at +49 (571) 887-44222.

**Item no.: 210-103**

Wire commoning chain; insulated; black

www.wago.com/210-103**Item no.: 2002-424/000-006**

Continuous jumper; from 1 to 4; insulated; blue

www.wago.com/2002-424/000-006**Ferrule**

Ferrule

**Item no.: 216-241**Ferrule; Sleeve for 0.5 mm² / 20 AWG; insulated; electro-tin plated; electrolytic copper; gastight crimped; acc. to DIN 46228, Part 4/09.90; whitewww.wago.com/216-241**Item no.: 216-242**Ferrule; Sleeve for 0.75 mm² / 18 AWG; insulated; electro-tin plated; electrolytic copper; gastight crimped; acc. to DIN 46228, Part 4/09.90; graywww.wago.com/216-242**Item no.: 216-243**Ferrule; Sleeve for 1 mm² / AWG 18; insulated; electro-tin plated; electrolytic copper; gastight crimped; acc. to DIN 46228, Part 4/09.90; redwww.wago.com/216-243**Item no.: 216-244**Ferrule; Sleeve for 1.5 mm² / AWG 16; insulated; electro-tin plated; electrolytic copper; gastight crimped; acc. to DIN 46228, Part 4/09.90; blackwww.wago.com/216-244**Item no.: 216-263**Ferrule; Sleeve for 1 mm² / AWG 18; insulated; electro-tin plated; electrolytic copper; gastight crimped; acc. to DIN 46228, Part 4/09.90; redwww.wago.com/216-263**Item no.: 216-246**Ferrule; Sleeve for 2.5 mm² / AWG 14; insulated; electro-tin plated; electrolytic copper; gastight crimped; acc. to DIN 46228, Part 4/09.90; bluewww.wago.com/216-246**Item no.: 216-266**Ferrule; Sleeve for 2.5 mm² / AWG 14; insulated; electro-tin plated; electrolytic copper; gastight crimped; acc. to DIN 46228, Part 4/09.90; bluewww.wago.com/216-266**Item no.: 216-264**Ferrule; Sleeve for 1.5 mm² / AWG 16; insulated; electro-tin plated; electrolytic copper; gastight crimped; acc. to DIN 46228, Part 4/09.90; blackwww.wago.com/216-264**Item no.: 216-262**Ferrule; Sleeve for 0.75 mm² / 18 AWG; insulated; electro-tin plated; electrolytic copper; gastight crimped; acc. to DIN 46228, Part 4/09.90; graywww.wago.com/216-262**Testing and measuring**

Testing accessories

**Item no.: 2009-174**

Test plug adapter; for 4 mm Ø test plugs; for testing TOPJOB®S rail-mounted terminal blocks; gray

www.wago.com/2009-174**Item no.: 2009-182**Testing tap; for max. 2.5 mm²; tool-free connection for individual test wires 0.08 - 2.5 mm; graywww.wago.com/2009-182**Item no.: 2002-511**Modular TOPJOB®S connector; modular; for jumper contact slot; 1-pole; 2,50 mm²; graywww.wago.com/2002-511

Subject to changes. Please also observe the further product documentation!

WAGO GmbH & Co. KG

Hansastr. 27













32423 Minden

Phone: +49571 887-0 | Fax: +49571 887-169

Email: info.de@wago.com | Web: www.wago.com

Do you have any questions about our products?

We are always happy to take your call at +49 (571) 887-44222.



	Item no.: 2002-549 Spacer module; modular; e.g., for bridging commoned terminal blocks; gray	www.wago.com/2002-549
	Item no.: 2002-552 Modular TOPJOB®S connector; modular; for jumper contact slot; 2-pole; 2,50 mm ² ; gray	www.wago.com/2002-552
	Item no.: 2002-558 Modular TOPJOB®S connector; modular; for jumper contact slot; 8-pole; 2,50 mm ² ; gray	www.wago.com/2002-558
	Item no.: 2002-559 Modular TOPJOB®S connector; modular; for jumper contact slot; 9-pole; 2,50 mm ² ; gray	www.wago.com/2002-559
	Item no.: 2002-556 Modular TOPJOB®S connector; modular; for jumper contact slot; 6-pole; 2,50 mm ² ; gray	www.wago.com/2002-556
	Item no.: 2002-553 Modular TOPJOB®S connector; modular; for jumper contact slot; 3-pole; 2,50 mm ² ; gray	www.wago.com/2002-553
	Item no.: 2002-611 TOPJOB®S L-type test plug module; modular; 1-pole; 2,50 mm ² ; gray	www.wago.com/2002-611
	Item no.: 2002-560 Modular TOPJOB®S connector; modular; for jumper contact slot; 10-pole; 2,50 mm ² ; gray	www.wago.com/2002-560
	Item no.: 2002-554 Modular TOPJOB®S connector; modular; for jumper contact slot; 4-pole; 2,50 mm ² ; gray	www.wago.com/2002-554
	Item no.: 2002-555 Modular TOPJOB®S connector; modular; for jumper contact slot; 5-pole; 2,50 mm ² ; gray	www.wago.com/2002-555
	Item no.: 2002-557 Modular TOPJOB®S connector; modular; for jumper contact slot; 7-pole; 2,50 mm ² ; gray	www.wago.com/2002-557
	Item no.: 2002-649 TOPJOB®S L-type spacer module; modular; e.g., for bridging commoned terminal blocks; gray	www.wago.com/2002-649
	Item no.: 210-136 Test plug; 2 mm Ø; with 500 mm cable; red	www.wago.com/210-136

Marking accessories

Marking strip













	Item no.: 2009-110 Marking strips; for Smart Printer; on reel; not stretchable; plain; snap-on type; white	www.wago.com/2009-110
--	--	--

Marker carrier













	Item no.: 2009-198 Adaptor; gray	www.wago.com/2009-198
	Item no.: 2002-161 Adaptor; gray	www.wago.com/2002-161

Subject to changes. Please also observe the further product documentation!

Marker

	Item no.: 2009-115/000-002 WMB-Inline; for Smart Printer; 1500 pieces on roll; stretchable 5 - 5.2 mm; plain; snap-on type; yellow	www.wago.com/2009-115/000-002
	Item no.: 2009-115/000-007 WMB-Inline; for Smart Printer; 1500 pieces on roll; stretchable 5 - 5.2 mm; plain; snap-on type; gray	www.wago.com/2009-115/000-007
	Item no.: 2009-115/000-017 WMB-Inline; for Smart Printer; 1500 pieces on roll; stretchable 5 - 5.2 mm; plain; snap-on type; light green	www.wago.com/2009-115/000-017
	Item no.: 2009-115/000-023 WMB-Inline; for Smart Printer; 1500 pieces on roll; stretchable 5 - 5.2 mm; plain; snap-on type; green	www.wago.com/2009-115/000-023
	Item no.: 2009-115/000-024 WMB-Inline; for Smart Printer; 1500 pieces on roll; stretchable 5 - 5.2 mm; plain; snap-on type; violet	www.wago.com/2009-115/000-024
	Item no.: 2009-145/000-006 Mini-WSB Inline; for Smart Printer; 1700 pieces on roll; stretchable 5 - 5.2 mm; plain; snap-on type; blue	www.wago.com/2009-145/000-006
	Item no.: 2009-145 Mini-WSB Inline; for Smart Printer; 1700 pieces on roll; stretchable 5 - 5.2 mm; plain; snap-on type; white	www.wago.com/2009-145
	Item no.: 2009-145/000-002 Mini-WSB Inline; for Smart Printer; 1700 pieces on roll; stretchable 5 - 5.2 mm; plain; snap-on type; yellow	www.wago.com/2009-145/000-002
	Item no.: 2009-145/000-007 Mini-WSB Inline; for Smart Printer; 1700 pieces on roll; stretchable 5 - 5.2 mm; plain; snap-on type; gray	www.wago.com/2009-145/000-007
	Item no.: 2009-145/000-005 Mini-WSB Inline; for Smart Printer; 1700 pieces on roll; stretchable 5 - 5.2 mm; plain; snap-on type; red	www.wago.com/2009-145/000-005
	Item no.: 2009-145/000-012 Mini-WSB Inline; for Smart Printer; 1700 pieces on roll; stretchable 5 - 5.2 mm; plain; snap-on type; orange	www.wago.com/2009-145/000-012
	Item no.: 2009-145/000-023 Mini-WSB Inline; for Smart Printer; 1700 pieces on roll; stretchable 5 - 5.2 mm; plain; snap-on type; green	www.wago.com/2009-145/000-023
	Item no.: 2009-145/000-024 Mini-WSB Inline; for Smart Printer; 1700 pieces on roll; stretchable 5 - 5.2 mm; plain; snap-on type; violet	www.wago.com/2009-145/000-024

Subject to changes. Please also observe the further product documentation!

	<p>Item no.: 2009-115 WMB-Inline; for Smart Printer; 1500 pieces on roll; stretchable 5 - 5.2 mm; plain; snap-on type; white</p>	www.wago.com/2009-115
	<p>Item no.: 248-501/000-006 Mini-WSB marking card; as card; not stretchable; plain; snap-on type; blue</p>	www.wago.com/248-501/000-006
	<p>Item no.: 248-501/000-007 Mini-WSB marking card; as card; not stretchable; plain; snap-on type; gray</p>	www.wago.com/248-501/000-007
	<p>Item no.: 248-501/000-002 Mini-WSB marking card; as card; not stretchable; plain; snap-on type; yellow</p>	www.wago.com/248-501/000-002
	<p>Item no.: 248-501/000-012 Mini-WSB marking card; as card; not stretchable; plain; snap-on type; orange</p>	www.wago.com/248-501/000-012
	<p>Item no.: 248-501 Mini-WSB marking card; as card; not stretchable; plain; snap-on type; white</p>	www.wago.com/248-501
	<p>Item no.: 248-501/000-017 Mini-WSB marking card; as card; not stretchable; plain; snap-on type; light green</p>	www.wago.com/248-501/000-017
	<p>Item no.: 248-501/000-005 Mini-WSB marking card; as card; not stretchable; plain; snap-on type; red</p>	www.wago.com/248-501/000-005
	<p>Item no.: 248-501/000-024 Mini-WSB marking card; as card; not stretchable; plain; snap-on type; violet</p>	www.wago.com/248-501/000-024
	<p>Item no.: 248-501/000-023 Mini-WSB marking card; as card; not stretchable; plain; snap-on type; green</p>	www.wago.com/248-501/000-023
	<p>Item no.: 793-5501/000-007 WMB marking card; as card; for terminal block width 5 - 17.5 mm; stretchable 5 - 5.2 mm; plain; snap-on type; gray</p>	www.wago.com/793-5501/000-007
	<p>Item no.: 793-5501/000-012 WMB marking card; as card; for terminal block width 5 - 17.5 mm; stretchable 5 - 5.2 mm; plain; snap-on type; orange</p>	www.wago.com/793-5501/000-012

Subject to changes. Please also observe the further product documentation!



Item no.: 793-5501/000-017

WMB marking card; as card; for terminal block width 5 - 17.5 mm; stretchable 5 - 5.2 mm; plain; snap-on type; light green www.wago.com/793-5501/000-017



Item no.: 793-5501/000-023

WMB marking card; as card; for terminal block width 5 - 17.5 mm; stretchable 5 - 5.2 mm; plain; snap-on type; green www.wago.com/793-5501/000-023



Item no.: 793-5501/000-024

WMB marking card; as card; for terminal block width 5 - 17.5 mm; stretchable 5 - 5.2 mm; plain; snap-on type; violet www.wago.com/793-5501/000-024



Item no.: 793-5501/000-005

WMB marking card; as card; for terminal block width 5 - 17.5 mm; stretchable 5 - 5.2 mm; plain; snap-on type; red www.wago.com/793-5501/000-005



Item no.: 793-5501/000-002

WMB marking card; as card; for terminal block width 5 - 17.5 mm; stretchable 5 - 5.2 mm; plain; snap-on type; yellow www.wago.com/793-5501/000-002



Item no.: 793-5501/000-006

WMB marking card; as card; for terminal block width 5 - 17.5 mm; stretchable 5 - 5.2 mm; plain; snap-on type; blue www.wago.com/793-5501/000-006



Item no.: 793-5501

WMB marking card; as card; for terminal block width 5 - 17.5 mm; stretchable 5 - 5.2 mm; plain; snap-on type; white www.wago.com/793-5501



Item no.: 2009-115/000-012

WMB-Inline; for Smart Printer; 1500 pieces on roll; stretchable 5 - 5.2 mm; plain; snap-on type; orange www.wago.com/2009-115/000-012



Item no.: 2009-115/000-006

WMB-Inline; for Smart Printer; 1500 pieces on roll; stretchable 5 - 5.2 mm; plain; snap-on type; blue www.wago.com/2009-115/000-006

Group marker carrier



Item no.: 2009-193

Group marker carrier; gray www.wago.com/2009-193



Item no.: 2009-192

Group marker carrier; gray www.wago.com/2009-192



Item no.: 2009-191

Group marker carrier; gray www.wago.com/2009-191

Protective warning marker

Cover

Subject to changes. Please also observe the further product documentation!



Item no.: 2002-115

Protective warning marker; for 5 terminal blocks; with high-voltage symbol, black; yellow

www.wago.com/2002-115

Downloads

Documentation

Bid Text

2102-1304 X81 - Datei	2019 May 15	xml 4.1 kB	Download
--------------------------	-------------	---------------	----------

2102-1304 docx - Datei	2019 May 14	docx 15.0 kB	Download
---------------------------	-------------	-----------------	----------

Additional Information

Technical Section Technical explanations		pdf 2.2 MB	Download
---	--	---------------	----------

CAD/CAE-Data

CAE data

EPLAN Data Portal 2102-1304		URL	Download
-----------------------------	--	-----	----------

ZUKEN Portal 2102-1304		URL	Download
------------------------	--	-----	----------

CAD data

2D/3D Models 2102-1304		URL	Download
------------------------	--	-----	----------

Environmental Product Compliance

Compliance Search

Environmental Product Compliance 2102-1304		URL	Download
--	--	-----	----------

3-conductor through terminal block; with lever and Push-in CAGE CLAMP®; 2,5 mm²; with test port; suitable for Ex i applications; side and center marking; for DIN-rail 35 x 15 and 35 x 7.5; Push-in CAGE CLAMP®; 2,50 mm²; blue

Subject to changes. Please also observe the further product documentation!

WAGO GmbH & Co. KG

Hansastr. 27

32423 Minden

Phone: +49571 887-0 | Fax: +49571 887-169

Email: info.de@wago.com | Web: www.wago.com

Do you have any questions about our products?

We are always happy to take your call at +49 (571) 887-44222.

Installation Notes

Conductor termination

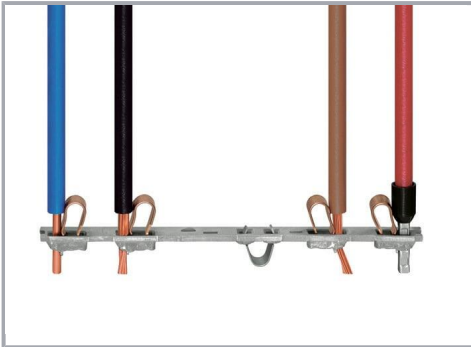

All conductor types at a glance

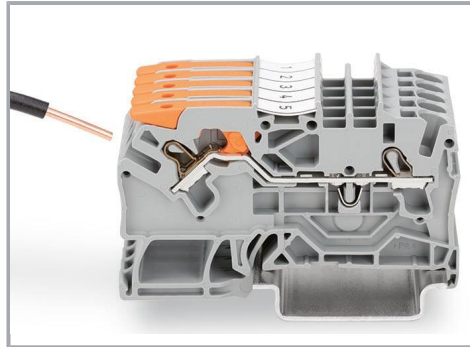

Push-in termination of solid conductors

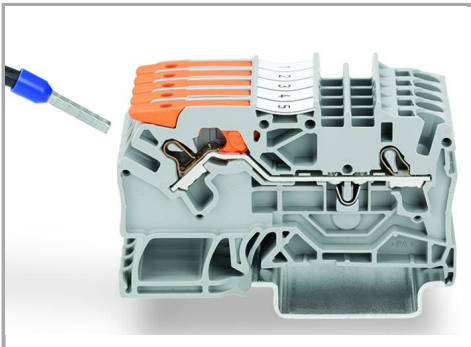

Push-in termination of fine-stranded conductors with ferrules

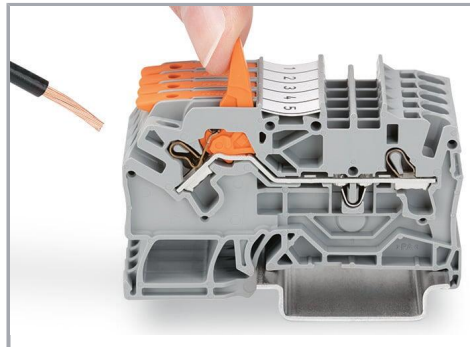

Pull the lever up until it stops, then connect the fine-stranded conductor.

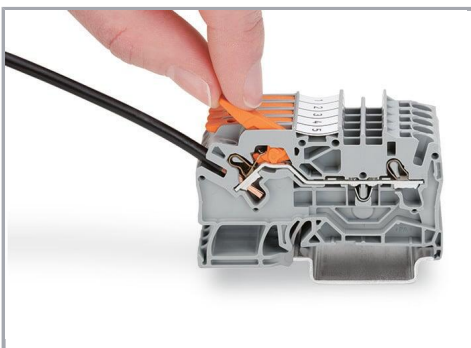

Push the lever back down – done!

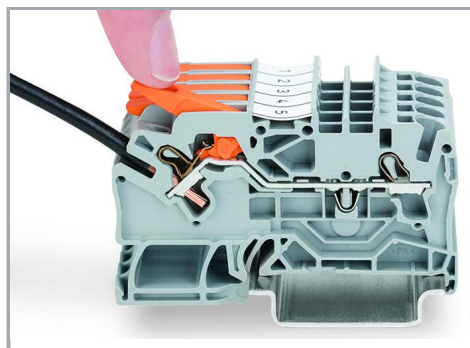

Push the lever back down – done!

Commoning

Subject to changes. Please also observe the further product documentation!

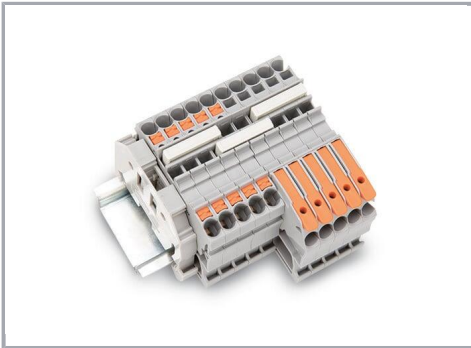

Insert a push-in type jumper bar and push down until it hits the backstop.

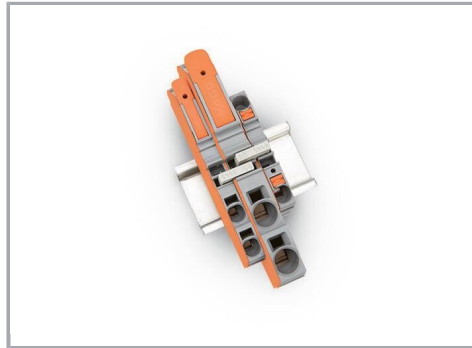

Commoning with step-down jumpers.

Testing

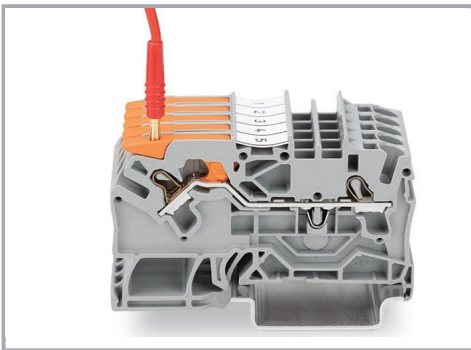

Testing with a 2 mm Ø test plug (max. 42 V).

Marking

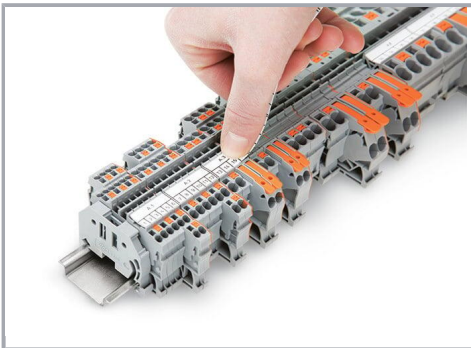

Snapping a marking strip into a marker slot.



Snapping a marking strip into the marker slot.

Product family

Subject to changes. Please also observe the further product documentation!

WAGO GmbH & Co. KG
Hansastr. 27
32423 Minden
Phone: +49571 887-0 | Fax: +49571 887-169
Email: info.de@wago.com | Web: www.wago.com

Do you have any questions about our products?
We are always happy to take your call at +49 (571) 887-44222.



TOPJOB® S

TOPJOB® S: In various industrial applications and modern building installations, WAGO's wide and versatile range of rail-mount terminal blocks provides more than just reliable electrical connections.

[Show all products from the family](#)

Subject to changes. Please also observe the further product documentation!

WAGO GmbH & Co. KG
Hansastr. 27
32423 Minden
Phone: +49571 887-0 | Fax: +49571 887-169
Email: info.de@wago.com | Web: www.wago.com

Do you have any questions about our products?
We are always happy to take your call at +49 (571) 887-44222.