

1S8W_5.2RP Series

1W - Dual/Single Output - Wide Input - Isolated & Regulated DC-DC Converter

DC-DC Converter

1 Watt

- ⊕ Wide 2:1 Input Voltage Range
- ⊕ High Efficiency up to 81%
- ⊕ 1W Single and Dual outputs
- ⊕ I/O Isolation 5.2kVDC
- ⊕ Operating Temperature Range: -40°C to +100°C
- ⊕ Continuous Short Circuit Protection (SCP)
- ⊕ Remote ON/OFF Control

The 1S8W_S & 1S8W_D series are specially designed for applications where a wide range input voltage power supplies are isolated from the input power supply in a distributed power supply system on a circuit board.

These products apply to:

- 1) Where the voltage of the input power supply is wide range (voltage range $\leq 2:1$)
- 2) Where isolation is necessary between input and output (isolation voltage $\leq 5200\text{VDC}$)
- 3) Where the regulation of the output voltage and the output ripple noise are demanded



Common specifications	
Input filter:	Capacitor
Short circuit protection:	Continuous
Temperature rise at full load:	15°C TYP
Cooling:	Free air convection
Operation temperature range:	-40°C~+100°C
Operating case temperature:	110°C MAX
Storage temperature range:	-55°C ~+125°C
Storage humidity range:	< 95%
Lead temperature range:	300°C MAX, 1.5mm from case for 10 sec
No-load power consumption:	50mW TYP / 150mW MAX
Temperature coefficient:	-40°C to +85°C ambient 0.015 %/°C TYP
Operating Frequency:	150kHz MIN (optional typ. 200kHz)
Case material:	Non-conductive black plastic [UL94-V0]
Potting material:	Epoxy [UL94-V0]
MTBF (MIL-HDBK 217F):	+25°C: 3650x10 ³ hours +85°C: 647x10 ³ hours
Weight:	4.7g

Output specifications						
Item	Test condition	Min	Typ	Max	Units	
Output voltage accuracy	Nominal Vin and full load		±2		%	
Line regulation	Vin=min to max, full load		±0.5		%	
Load regulation	20% to 100% full load		±0.5		%	
Output Ripple & Noise	20MHz Bandwidth			60	mVp-p	
Remote Power OFF (leave open if not used) (15 VDC max.)	Device ON				open or <0.8 VDC	
	Device OFF Device OFF (Stand by input current)				CTRL>1.5VDC 0.5mA max.	

Example:

1S8W_0505S5.2RP

1 = 1Watt; S8 = SIP8; W = wide input (2:1); 4,5 - 9Vin; 5Vout;

S = Single Output; 5.2 = 5200VDC Isolation; R = Regulated Output

P = Short Circuit Protection

Isolation specifications						
Item	Test condition	Min	Typ	Max	Units	
Isolation voltage	Tested for 1 minute and 0,5mA max.	5200			VDC	
Isolation resistance	500VDC, input to output	15			GΩ	
Isolation capacitance	100KHz			30	pF	

Note:

1. All specifications measured at Ta = 25°C, humidity <75%, nominal input voltage and rated output load unless otherwise specified.
2. In this datasheet, all the test methods of indications are based on corporate standards.

1S8W_5.2RP Series

1W - Dual/Single Output - Wide Input - Isolated & Regulated DC-DC Converter

Part Number	Input Voltage [V]	Output Voltage [VDC]	Output Current [mA, max]	Efficiency [%, typ]	Max. Capacitive Load [μ F]
1S8W_xx03S5.2RP	4.5-9, 9-18, 18-36, 36-75	3.3	200	77-78	470
1S8W_xx05S5.2RP	4.5-9, 9-18, 18-36, 36-75	5	200	78-80	470
1S8W_xx09S5.2RP	4.5-9, 9-18, 18-36, 36-75	9	111	78-80	330
1S8W_xx12S5.2RP	4.5-9, 9-18, 18-36, 36-75	12	83	78-81	220
1S8W_xx15S5.2RP	4.5-9, 9-18, 18-36, 36-75	15	66	78-81	220
1S8W_xx03D5.2RP	4.5-9, 9-18, 18-36, 36-75	\pm 3.3	\pm 100	76-78	\pm 220
1S8W_xx05D5.2RP	4.5-9, 9-18, 18-36, 36-75	\pm 5	\pm 100	78-80	\pm 220
1S8W_xx09D5.2RP	4.5-9, 9-18, 18-36, 36-75	\pm 9	\pm 55	78-80	\pm 150
1S8W_xx12D5.2RP	4.5-9, 9-18, 18-36, 36-75	\pm 12	\pm 42	78-81	\pm 100
1S8W_xx15D5.2RP	4.5-9, 9-18, 18-36, 36-75	\pm 15	\pm 33	78-81	\pm 100

- xx=Input Voltage (possible for other input and output voltage combinations on request)
 Vin=4.5-9V, xx=05
 Vin=9-18V, xx=12
 Vin=18-36V, xx=24
 Vin=36-75V, xx=48

Functional block diagram

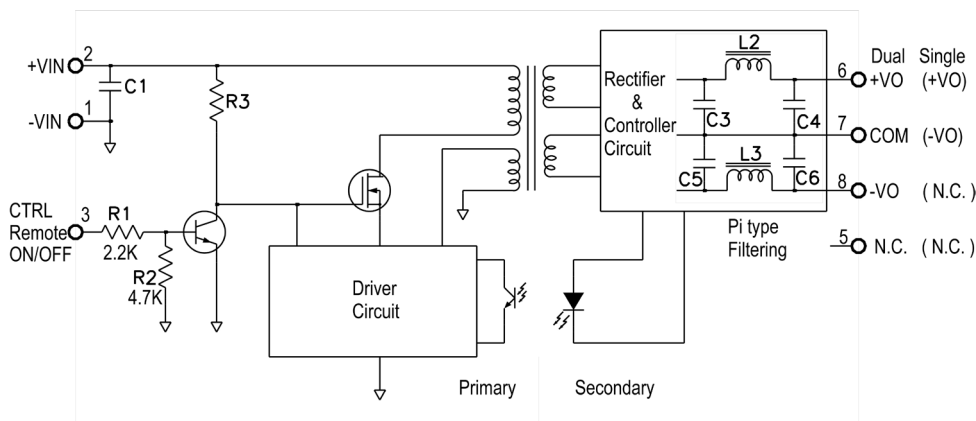

Input voltage	C1 values
4.5-18V	10 μ F/25V
18-36V	4.7 μ F/50V
36-75V	1 μ F/100V

Mechanical dimensions and footprint

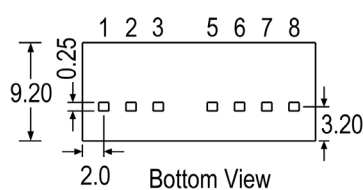
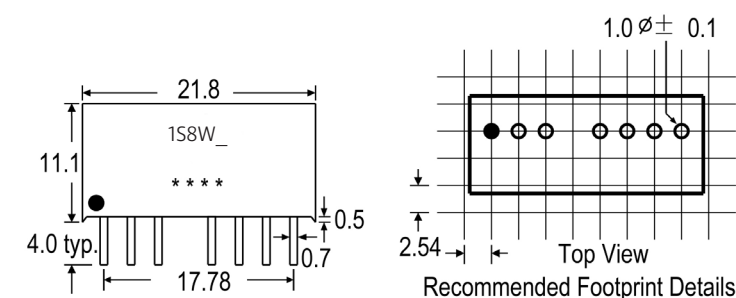

Pin Connections

Pin#	Single	Dual
1	-Vin	-Vin
2	+Vin	+Vin
3	CTRL	CTRL
5	NC	NC
6	+Vout	+Vout
7	-Vout	COM
8	NC	-Vout

NC=No Connection

CTRL=Remote ON/OFF Control

1S8W_5.2RP Series

1W - Dual/Single Output - Wide Input - Isolated & Regulated DC-DC Converter

Typical characteristics

Derating graph (Natural convection)

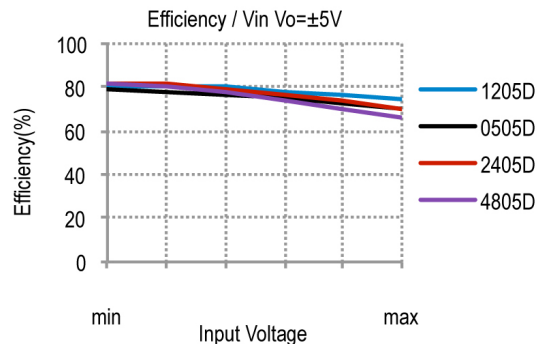
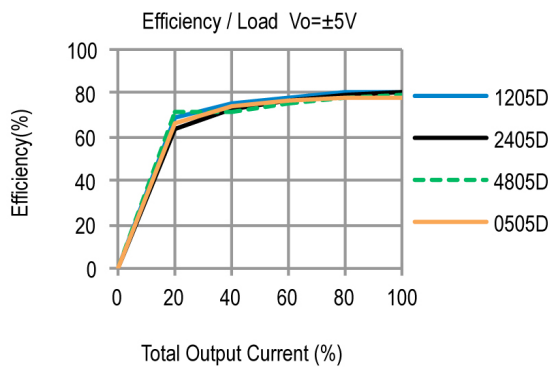
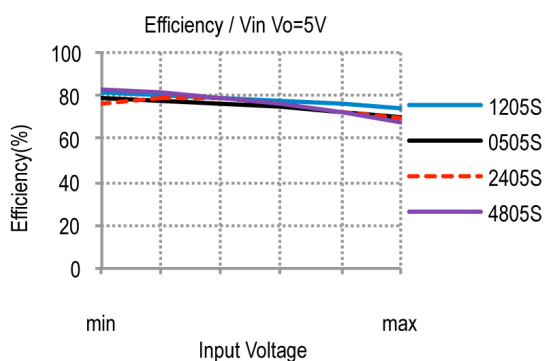
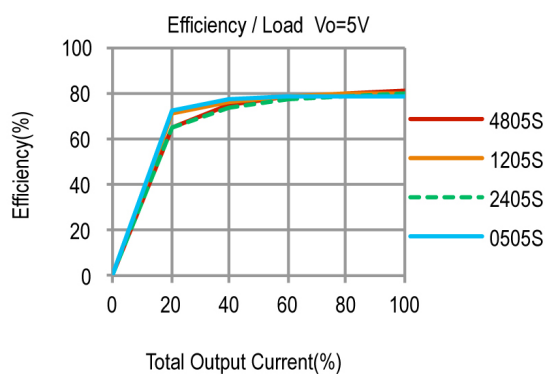
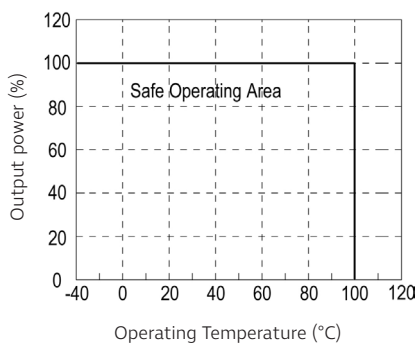

Tube outline

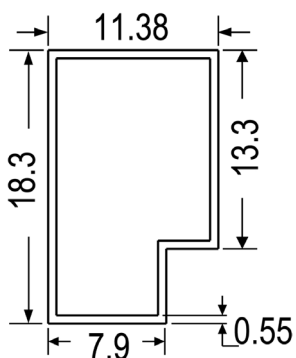

Note:
Unit: mm[inch]
General tolerances: ±0.50mm

L=520mm
Tube quantity: 23pcs