

EZO-PMPTM

Embedded Dosing Pump

Flow rate	0.5ml to 105ml/min
Accuracy	+/- 1%
Viscosity	0.1 – 2,000 cP
Modes of operation	Continuous dispensing Volume dispensing Dose over time Constant flow rate Dispense at startup
Connector	5 lead data cable
Calibration	Single point
Tubing size	Any 5mm O.D. tubing
Data protocol	UART & I²C
Default I ² C address	103 (0x67)
Operating voltage	3.3V – 5V (logic) 12V – 24V (motor)
Pump head	8.1 meters (26.5')
Data format	ASCII
Food Safe	Yes

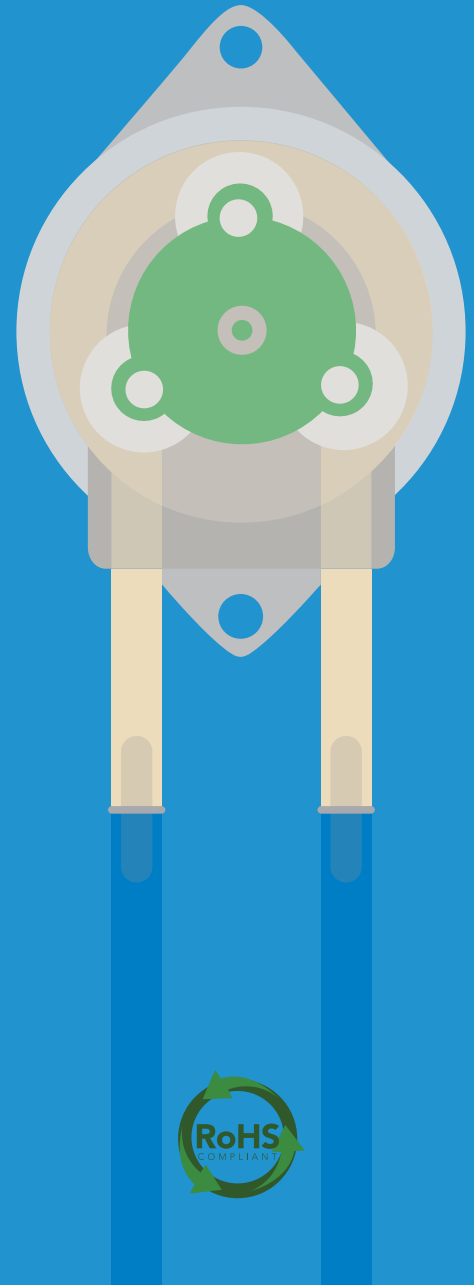

Table of contents

EZO-PMP™ dimensions	4	Operating modes	6
EZO-PMP™ tubing	5	Available data protocols	8
Operating principle	6	Default state	9

UART

UART mode	11
Receiving data from device	12
Sending commands to device	13
LED color definition	14
UART quick command page	15
LED control	16
Find	17
Continuous mode	18
Single reading mode	19
Continuous dispensing	20
Volume dispensing	21
Dose over time	22
Constant flow rate	23
Dispense at startup	24
Pause dispensing	27
Stop dispensing	28
Invert dispensing direction	29
Total volume dispensed	30
Calibration	31
Enable/disable parameters	32
Pump voltage	33
Naming device	34
Device information	35
Response codes	36
Reading device status	37
Sleep mode/low power	38
Change baud rate	39
Protocol lock	40
Factory reset	41
Change to I ² C mode	42
Manual switching to I ² C	43

Calibration theory	77
Accuracy	82
Viscosity	83

I²C

I ² C mode	45
Sending commands	46
Requesting data	47
Response codes	48
LED color definition	49
I²C quick command page	50
LED control	51
Find	52
Single report mode	53
Continuous dispensing	54
Volume dispensing	55
Dose over time	56
Constant flow rate	57
Dispense at startup	58
Pause dispensing	61
Stop dispensing	62
Invert dispensing direction	63
Total volume dispensed	64
Calibration	65
Enable/disable parameters	66
Pump voltage	67
Naming device	68
Device information	69
Reading device status	70
Sleep mode/low power	71
Protocol lock	72
I ² C address change	73
Factory reset	74
Change to UART mode	75
Manual switching to UART	76

Mounting the EZO-PMP™	84
Datasheet change log	85
Warranty	87

Attention

The EZO-PMP™ Embedded Dosing Pump requires two power supplies to operate.

12V – 24V
to drive the motor

3.3V – 5.5V
for the control system

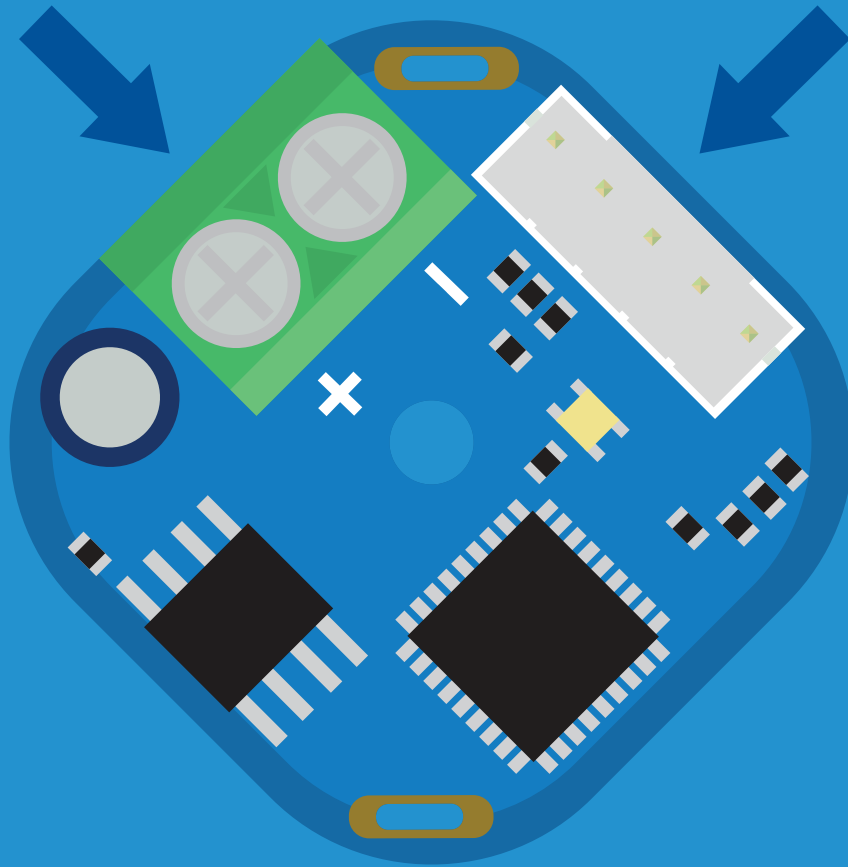

Control system
(Back side of dosing pump)

EZO-PMP™ dimensions

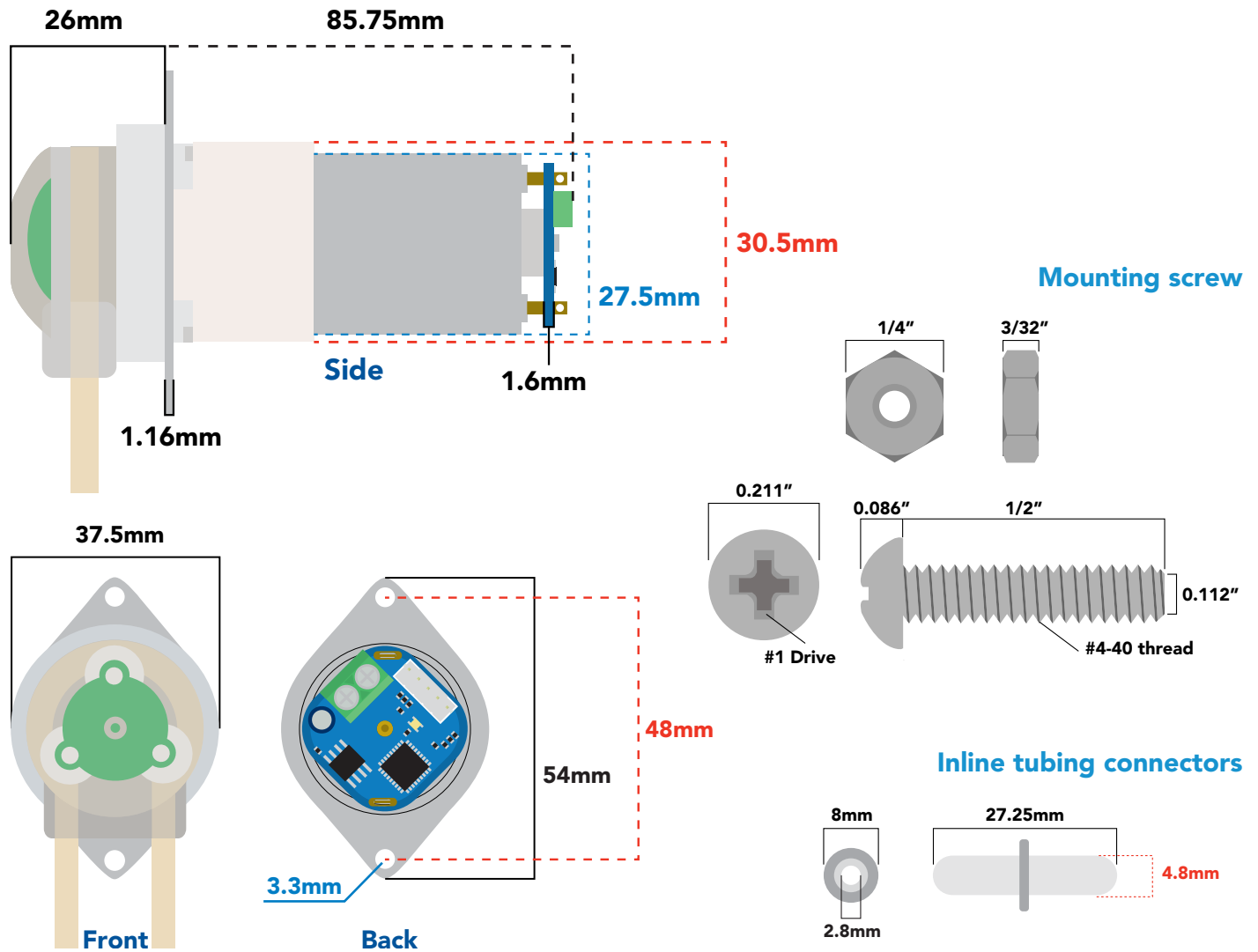

Power consumption

	LED	MAX	STANDBY	SLEEP
5V	ON	13.7 mA	13.4 mA	0.415 mA
	OFF	13.1 mA	12.8 mA	
3.3V	ON	12.5 mA	12.4 mA	0.13 mA
	OFF	12.3 mA	12.2 mA	
Motor	12V = ~400mA		24V = ~200mA	

Tubing life span	+1,000 hrs.
Cassette life span	1,500 hrs.
Motor life span	5,000 hrs.

Absolute max ratings

Parameter	MIN	TYP	MAX
Storage temperature (EZO-PMP™)	-65 °C		125 °C
Operational temperature (EZO-PMP™)	-40 °C	25 °C	85 °C
VCC	3.3V	5V	5.5V
Motor	10.8V	12V	24V
Max input/output pressure			80 kPa

EZO-PMP™ tubing

NSF/ANSI 51 Compliant

Tan tubing

Saint-Gobain™ PharMed™ BPT tubing

Length: 15.24cm

Outer diameter: 5mm

Inner diameter: 3mm

This tubing is highly chemically resistant and has 30X more resistant to mechanical wear than silicone tubing.



Inline tubing connectors

HDPE

Length: 2.54cm

Outer diameter: 8mm

Inner diameter: 2.8mm



Blue tubing

Silicone

Length: 2x 30.48cm

Outer diameter: 5mm

Inner diameter: 3mm

Bend radius: 15mm

Temperature -67°C to 200°C

Max pressure: 69 kPa (10 PSI)

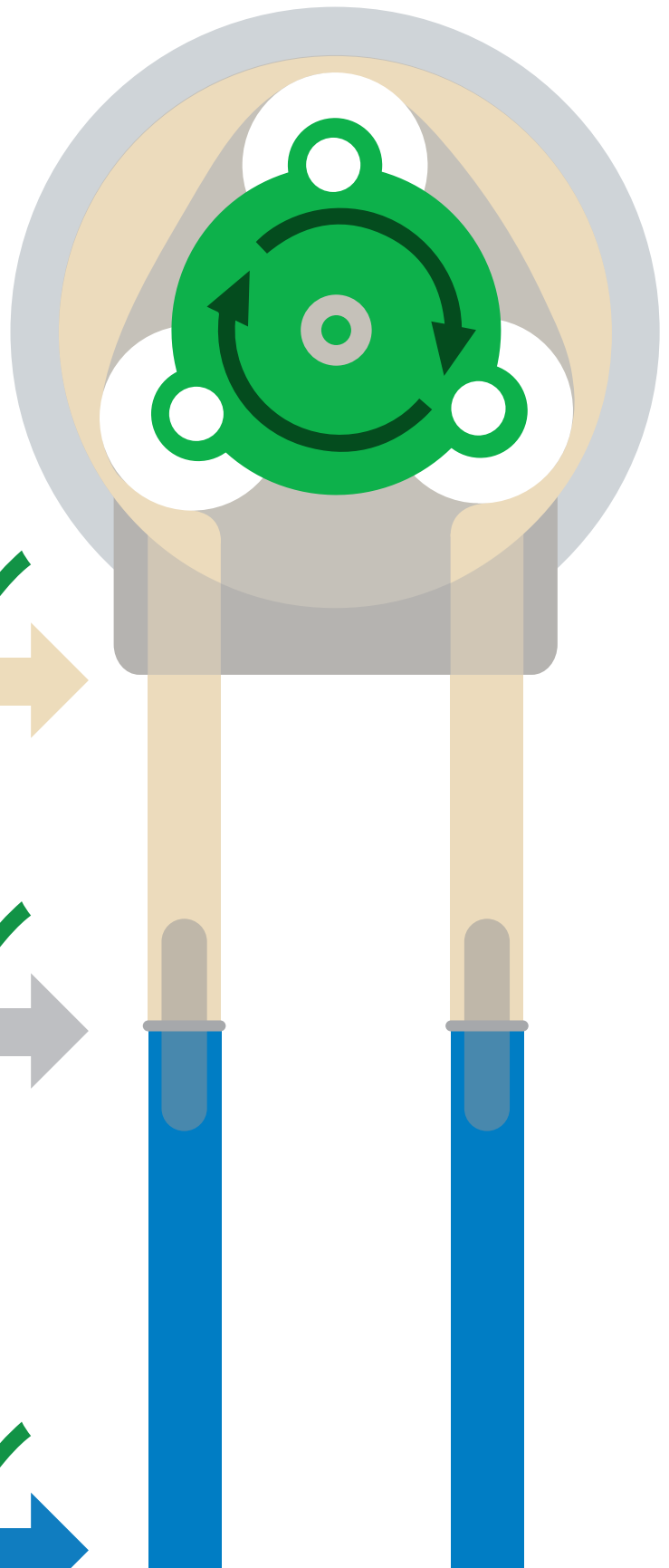

Operating principle

- ✓ Self-priming
- ✓ Run dry

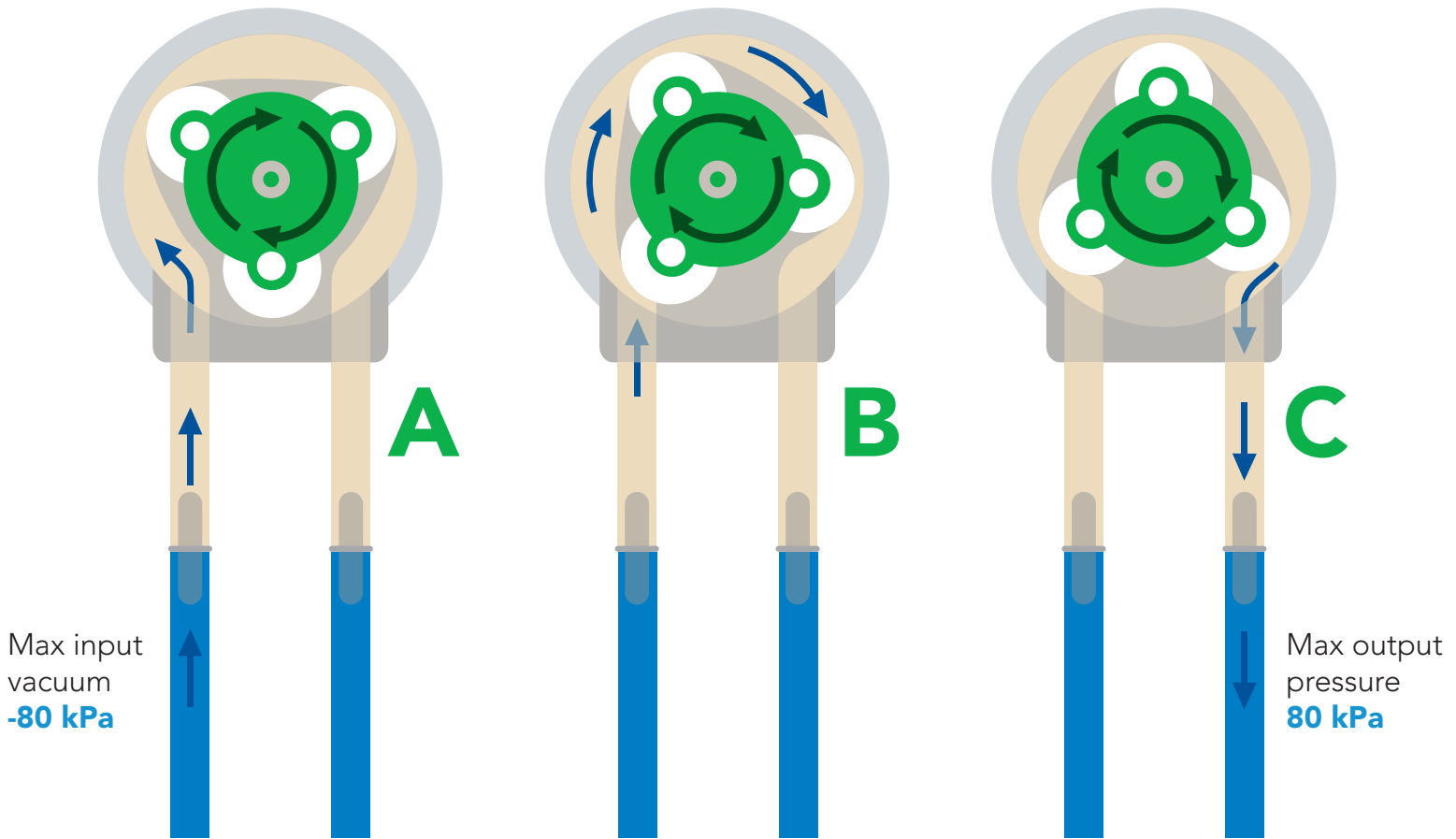

Operating modes

The EZO-PMP™ can operate in four different modes.

Continuous dispensing

Run the pump continuously
105 ml/min ∞ (with supplied tubing)

Volume dispensing

Pump a specific volume
(Smallest possible volume is 0.5 ml)

Volume is always in ml.

Dose over time

Pump a specific volume over a set time

Constant flow rate

Pump a specific volume per minute

Dispense at startup

- Dispense a specific volume at startup
- Continuous dispensing at startup
- Dose over time at startup

This device requires two power supplies

3.3V–5.5V for the control system

12V–24V to drive the motor

The Atlas Scientific EZO-PMP™ consists of three main components.

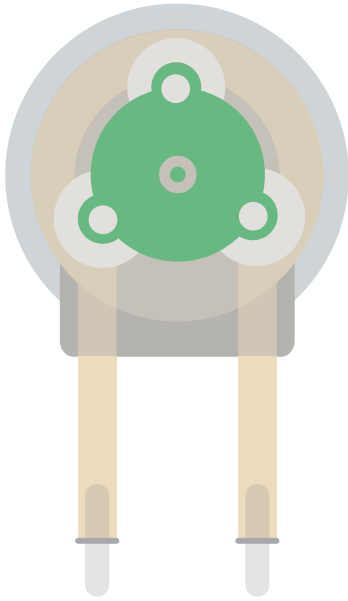

Cassette

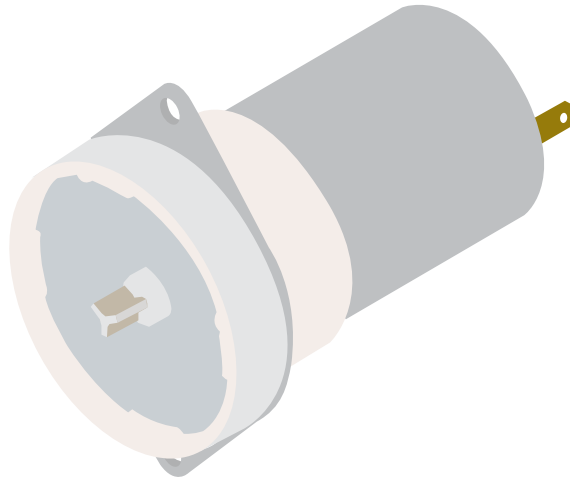

12 volt motor

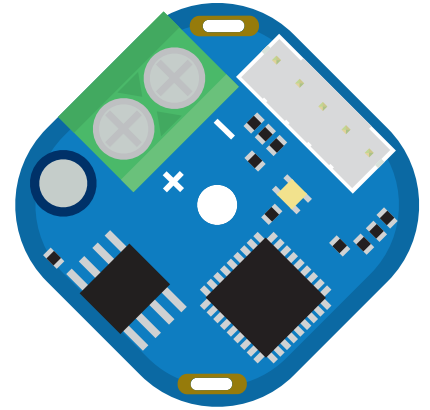

Control system

The actual peristaltic pumping is done within the cassette. It has been designed to be easily detached from the motor and disassembled.

The 12 volt motor and control system have been soldered together. Both components are designed to operate as one single unit.

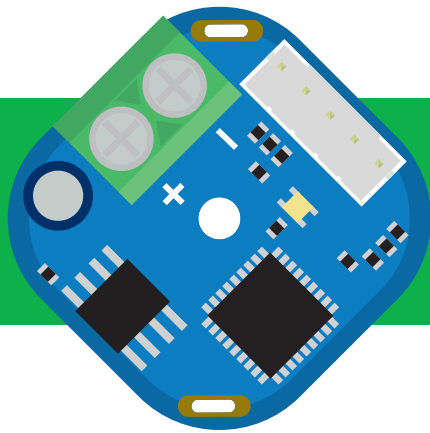

The control system has three main components

- Keyed data and power connector
- 12–24 volt power input
- Status indicator LED

Data and power cable pinout

- White** – RX/SCL
- Green** – TX/SDA
- Black** – GND
- Red** – VCC
- Blue** – INT



✓ Available data protocols

UART

Default

I²C

✗ Unavailable data protocols

SPI

Analog

RS-485

Mod Bus

4–20mA

Default state

UART mode

Baud	9,600
Readings	continuous
Speed	1 reading per second
LED	on

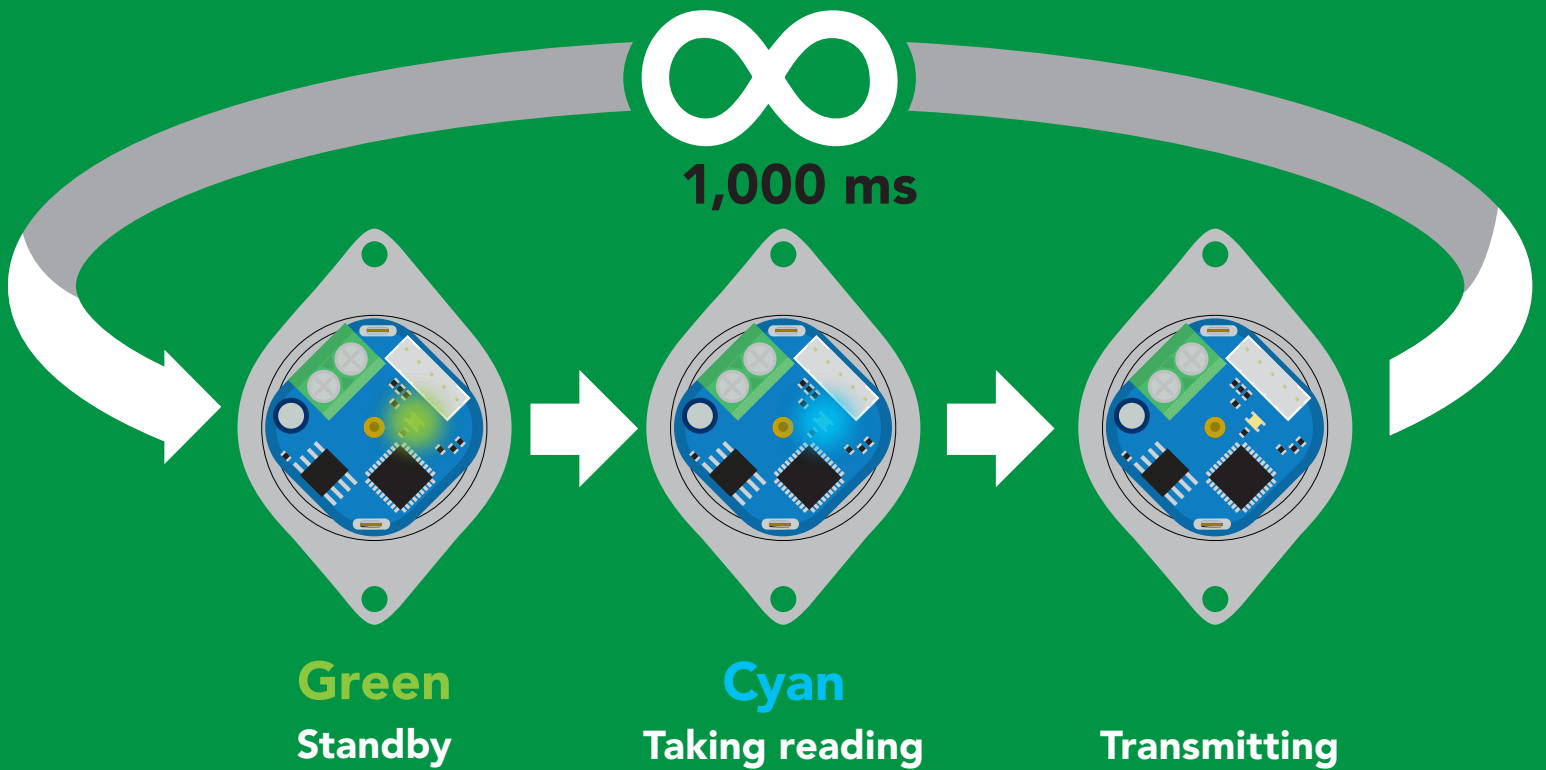

UART mode

Settings that are retained if power is cut

- Baud rate
- Calibration
- Continuous mode
- Device name
- Enable/disable parameters
- Enable/disable response codes
- Hardware switch to I²C mode
- Invert
- LED control
- Protocol lock
- Software switch to I²C mode

Settings that are **NOT** retained if power is cut

- Absolute total volume
- Find
- Sleep mode
- Total volume

UART mode

8 data bits
1 stop bit

no parity
no flow control

Baud 300
1,200
2,400
9,600 default
19,200
38,400
57,600
115,200



Vcc 3.3V – 5.5V

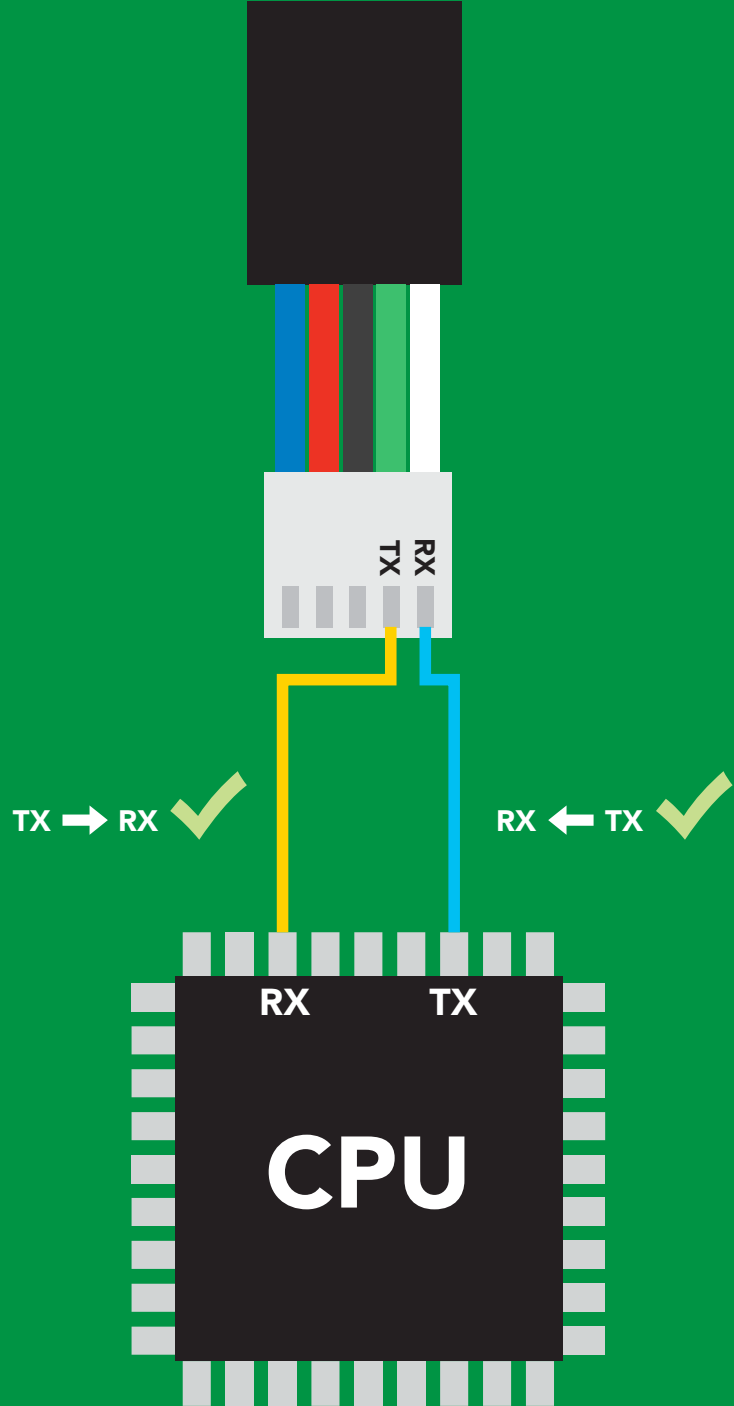

Data format

Output volume
Units ml
Encoding ASCII
Format string

Terminator carriage return
Data type floating point
Decimal places 2
Smallest string 3 characters
Largest string 39 characters

Receiving data from device

2 parts

ASCII data string

Command

Carriage return <cr>

Terminator

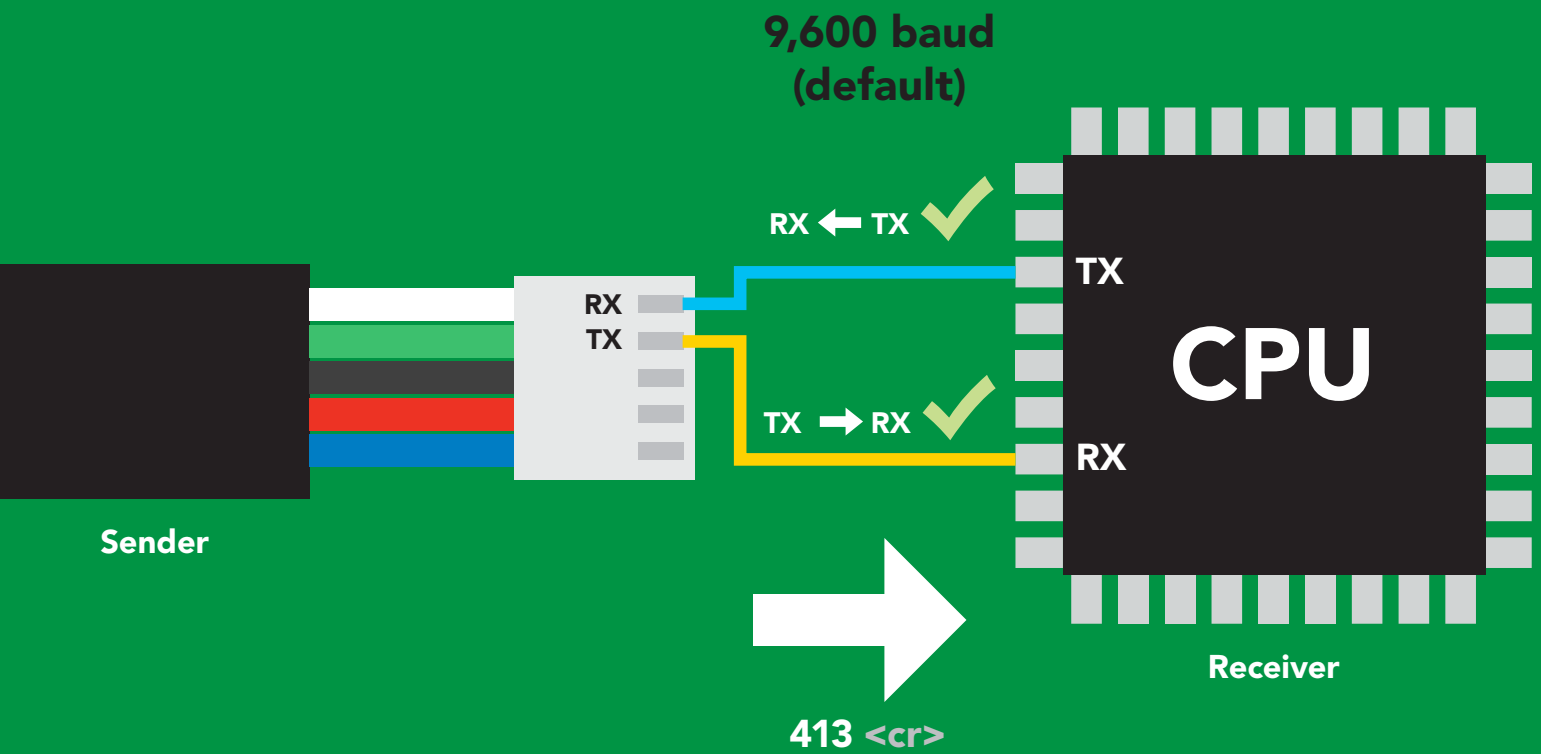

Advanced

ASCII: 4 1 3 <cr>

Hex: 34 31 33 0D

Dec: 52 49 51 13

Sending commands to device

2 parts

Command (not case sensitive)

ASCII data string

Carriage return <cr>

Terminator

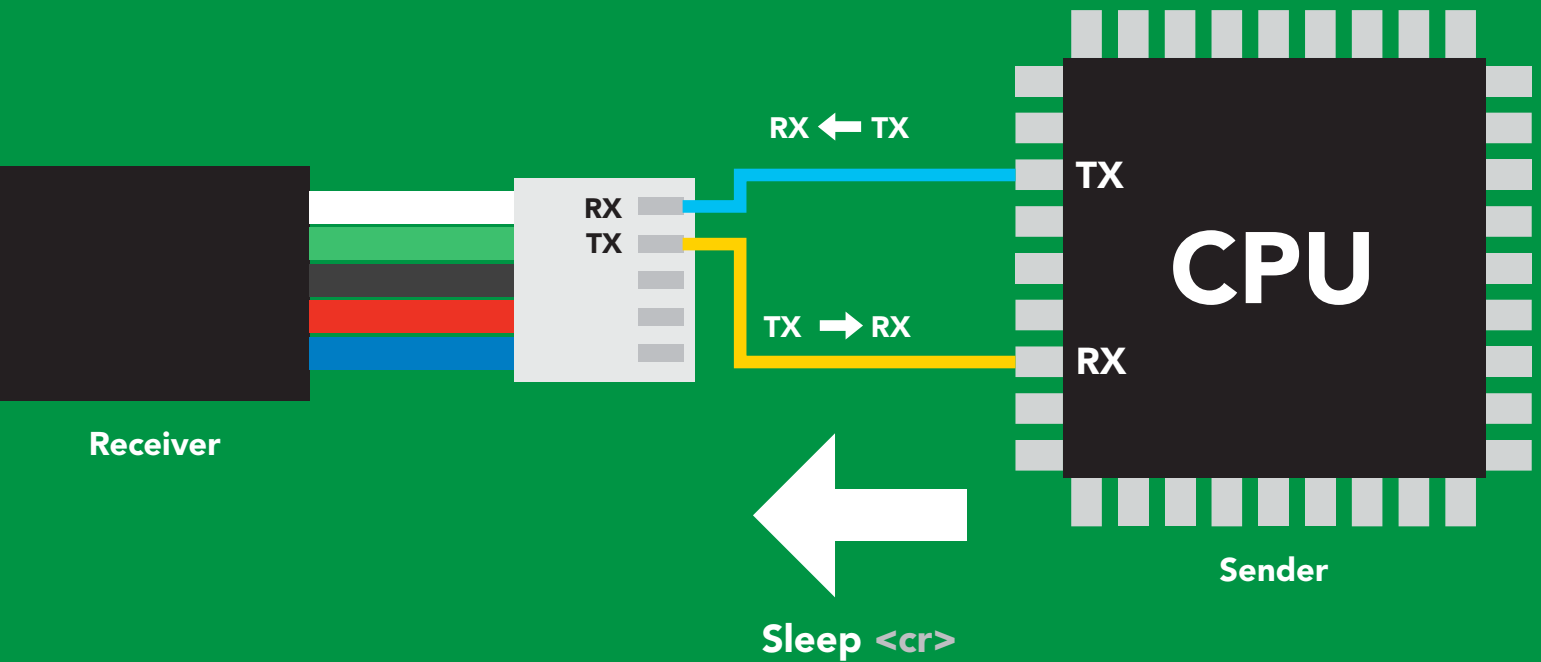

Advanced

ASCII: **S I e e p** <cr>

Hex: **53 6C 65 65 70** **0D**

Dec: **83 108 101 101 112** **13**

LED color definition



Green

UART standby



Cyan

Taking reading



Purple

Changing
baud rate

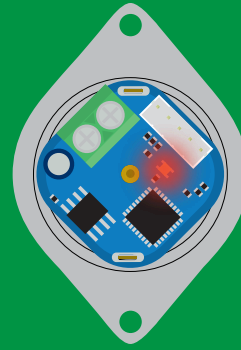

Red

Command
not understood



White

Find

5V

LED ON
+2.5 mA

3.3V

+1 mA

UART mode

command quick reference

All commands are ASCII strings or single ASCII characters.

Command	Function		Default state
Baud	change baud rate	pg. 39	9,600
C	enable/disable continuous mode	pg. 18	enabled
Cal	performs calibration	pg. 31	n/a
D	dispense modes	pg. 20 – 26	n/a
Factory	enable factory reset	pg. 41	n/a
Find	finds device with blinking white LED	pg. 17	n/a
i	device information	pg. 35	n/a
Invert	invert dispensing direction	pg. 29	n/a
I2C	change to I ² C mode	pg. 42	not set
L	enable/disable LED	pg. 16	enabled
Name	set/show name of device	pg. 34	not set
O	enable/disable parameters	pg. 32	all enabled
P	pause dispensing	pg. 27	n/a
Plock	enable/disable protocol lock	pg. 40	disabled
Pv	check pump voltage	pg. 33	n/a
R	returns a single reading	pg. 19	n/a
Sleep	enter sleep mode/low power	pg. 38	n/a
Status	retrieve status information	pg. 37	enable
Tv	total volume dispensed	pg. 30	n/a
X	stop dispensing	pg. 28	n/a
*OK	enable/disable response codes	pg. 36	enable

LED control

Command syntax

L,1 <cr> LED on **default**

L,0 <cr> LED off

L,? <cr> LED state on/off?

Example

Response

L,1 <cr>

*OK <cr>

L,0 <cr>

*OK <cr>

L,? <cr>

?L,1 <cr> or ?L,0 <cr>
*OK <cr>



L,1



L,0

Find

Command syntax

This command will disable continuous mode
Send any character or command to terminate find.

Find <cr> LED rapidly blinks white, used to help find device

Example

Find <cr>

Response

*OK <cr>

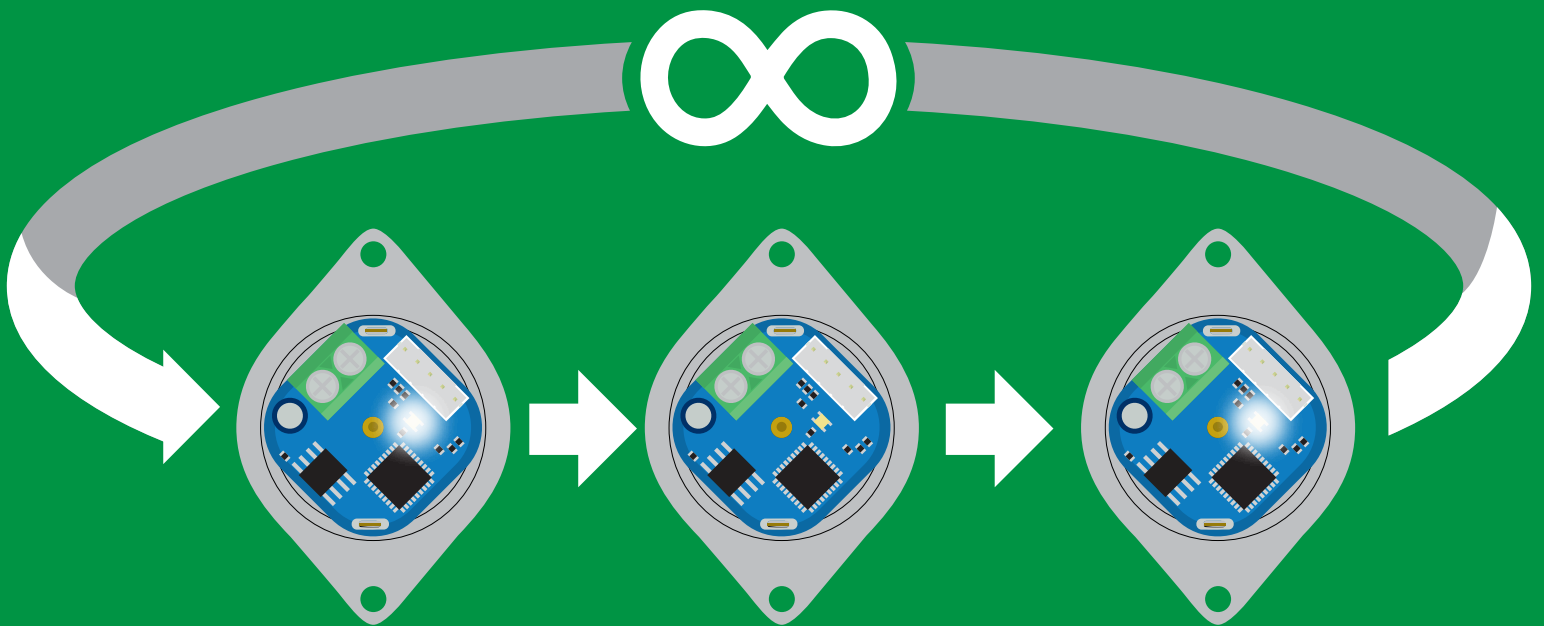

Continuous mode

Command syntax

- C,* <cr>** continuously reports volume once per second **default**
- C,1 <cr>** continuously reports volume only when pumping
- C,0 <cr>** disable continuous reporting
- C,? <cr>** continuous reporting mode on/off?

Example

Response

dispense 3ml

C,* <cr>

1.2 <cr>
3.0 <cr>
***Done,3.00 <cr>**
3.0 <cr>
3.0 <cr>

C,1 <cr>

1.2 <cr>
3.0 <cr>
***Done,3.00 <cr>**

C,0 <cr>

***Done,3.00 <cr>**

C,? <cr>

?C,1 <cr> or ?C,0 <cr> or ?C,* <cr>
***OK <cr>**

Single reading mode

Command syntax

R <cr> returns a single value showing dispensed volume

Example

Response

R <cr>

2.50 <cr> (If issued half way through dispensing 5ml)
***OK <cr>**

5.00 <cr> (If issued once dispensing has stopped)
***OK <cr>**

Continuous dispensing

Pump on/pump off

Command syntax

After running in continuous mode for 20 days the EZO-PMP™ will reset.

D,* <cr> dispense until the stop command is given

D,-* <cr> dispense in reverse until the stop command is given

D,? <cr> dispense status

Example

Response

D,* <cr>

***OK** <cr> pump will continuously run at ~105ml/min (with supplied tubing)

D,-* <cr>

***OK** <cr> pump will continuously run in reverse at ~105ml/min (with supplied tubing)

D,? <cr>

?D,*,1 <cr>
***OK** <cr>

Response breakdown

?D,*,1

↑ ↑
last volume pump on
requested

Volume dispensing

Pump a specific volume

Command syntax

where [ml] is any volume in millimeters ≥ 0.5

D,[ml] <cr> dispense [this specific volume]

D,[-ml] <cr> dispense [*in reverse* this specific volume]

D,? <cr> dispense status

Example

Response

D,15 <cr>

*OK <cr> 15 ml will be dispensed

D,-40.5 <cr>

*OK <cr> 40.5 ml will be dispensed *in reverse*

D,? <cr>

?D,-40.50,0 <cr>

*OK <cr>

Response breakdown

?D,-40.50,0

↑ last volume dispensed
↑ pump off

Dose over time

Pump a fixed volume over a fixed time

Command syntax

D,[ml],[min] <cr> Dispense [this volume], [over this many minutes]

Example

D,85,10 <cr>

Response

***OK <cr> Dispense 85ml over 10 minutes**



Constant flow rate

Maintain a constant flow rate

Command syntax

After running in continuous mode for 20 days the EZO-PMP™ will reset.

DC,[ml/min],[min or *] <cr> [maintain this rate],[for this much time]

DC,? <cr> reports maximum possible flow rate

[ml/min] = a single number (int or float) representing the desired flow rate

[min or *] = the number of minutes to run or (*) indefinitely

A negative value for ml/min = reverse

Example

Response

DC,25,40 <cr>

***OK <cr> Dispense 25ml per minute for 40 minutes**

DC,? <cr>

?MAXRATE,58.5 <cr>

***OK <cr>**

The maximum flow rate is determined after calibration.
If the flowrate entered is too fast the EZO-PMP™ will send an error.

***TOOFAST <cr>**

***ER <cr>**

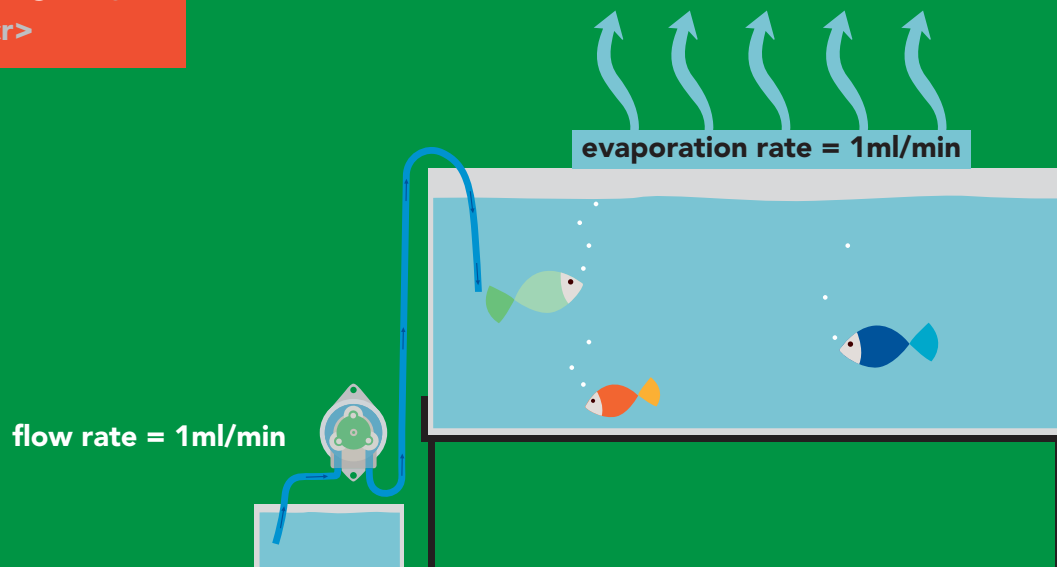

Dispense at startup

Pump a specific volume at startup and then stop

Use this command to make a simple fixed-volume pump

Command syntax

Dstart,[ml] <cr> dispense [this specific volume] at startup

Dstart,off <cr> disables dispense at startup mode

Dstart,? <cr> startup dispense status

Example

Response

Dstart,10 <cr>

***OK** <cr>

Dstart,off <cr>

***OK** <cr>

Dstart,? <cr>

?Dstart,10 <cr> or **?Dstart,0** <cr>
***OK** <cr>

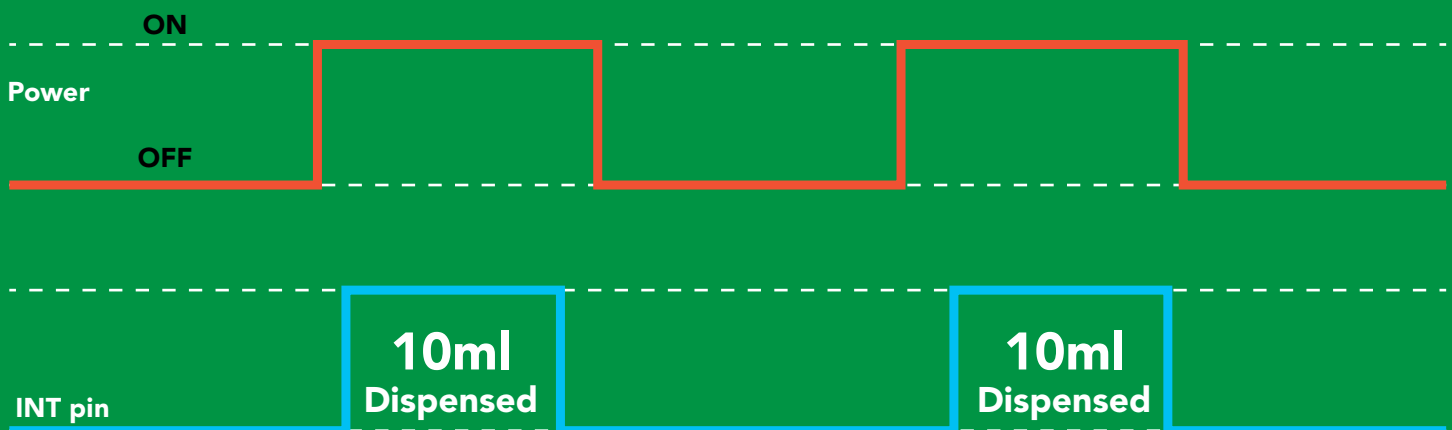

Continuous dispensing at startup

Pump on & continuously dispense

Command syntax

After running in continuous mode for 20 days the EZO-PMP™ will reset.

Dstart,* <cr> dispense at startup until the stop command is given

Dstart,-* <cr> dispense in reverse at startup until the stop command is given

Dstart,? <cr> startup dispense status

Example

Response

Dstart,* <cr>

***OK** <cr>

Pump will startup and continuously run at ~105ml/min (with supplied tubing)

Dstart,-* <cr>

***OK** <cr>

Pump will startup and continuously run in reverse at ~105ml/min (with supplied tubing)

Dstart,? <cr>

?Dstart,* <cr>



Dose Over time at startup

Pump a fixed volume over a fixed time at startup

Command syntax

D,[ml],[min] <cr> Dispense [this volume], [over this many minutes] at startup

Example

Dstart,85,10 <cr>

Response

***OK <cr>**

Pump will startup and dispense 85ml over 10 minutes

Dstart,? <cr>

?Dstart,85.00,10.00 <cr>

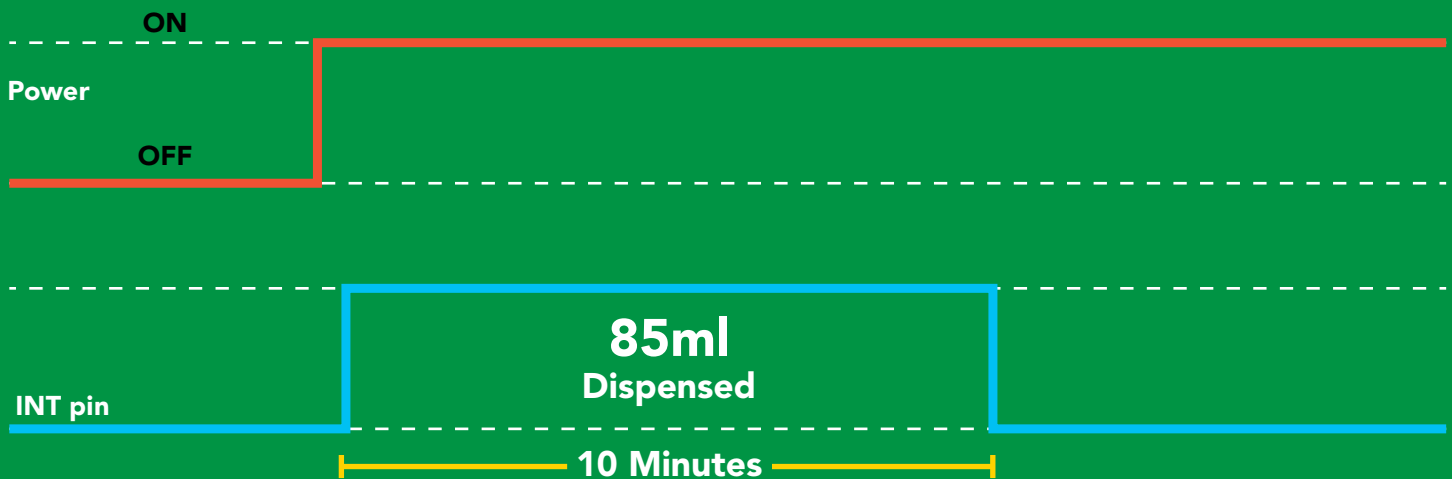

Pause dispensing

Command syntax

Issue the command again to resume dispensing

P <cr> pauses the pump during dispensing

P,? <cr> pause status

Example

Response

P <cr>

***OK** <cr>

P,? <cr>

?P,1 <cr> **or** **?P,0** <cr>
paused unpaused

***OK** <cr>

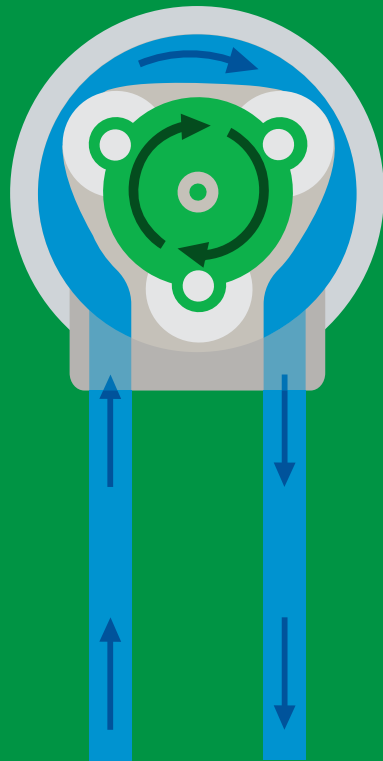

dispensing

P

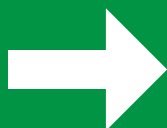

paused

P

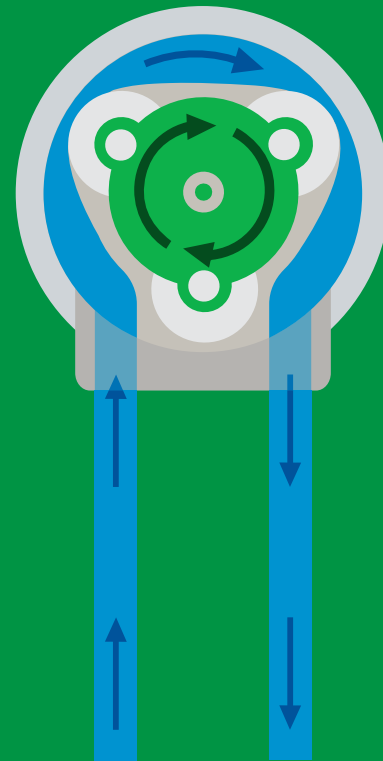

dispensing

Stop dispensing

Command syntax

X <cr> stop dispensing

Example

X <cr>

Response

***DONE,v** <cr> v = volume dispensed

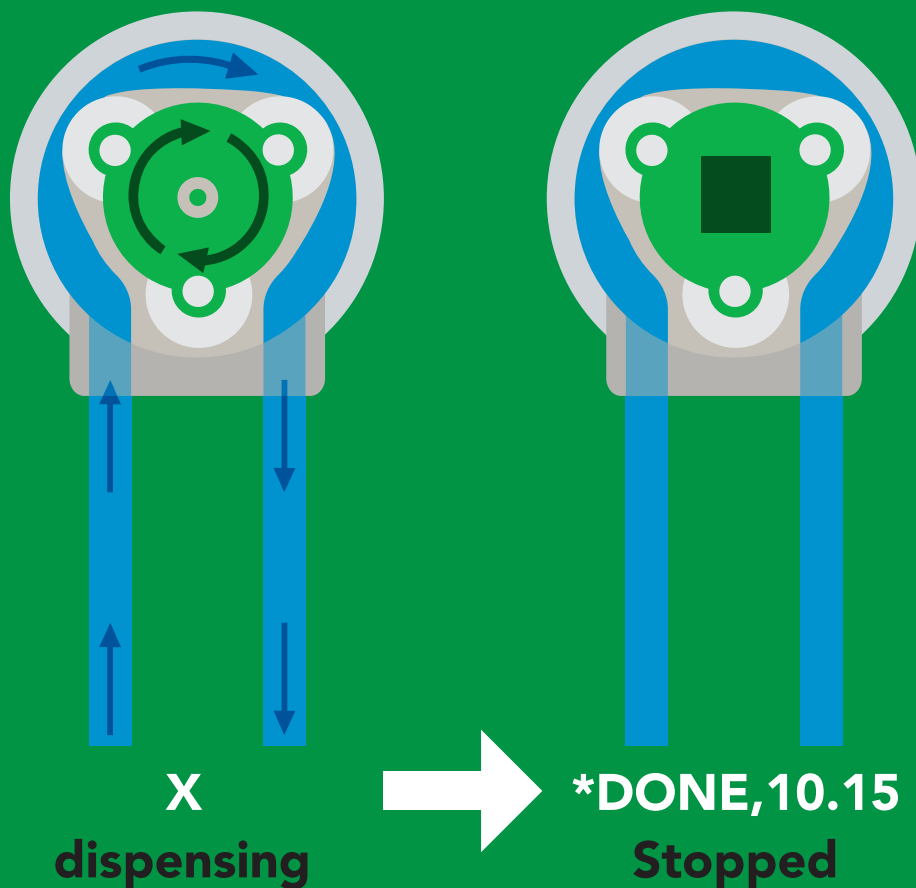

Invert dispensing direction

Command syntax

Invert direction will be retained if power is cut

Invert <cr> changes dispensing direction of pump

Example

Invert <cr>

***OK** <cr>

Invert,? <cr>

?Invert,1 <cr> **or** **?Invert,0** <cr>
inverted uninverted

***OK** <cr>

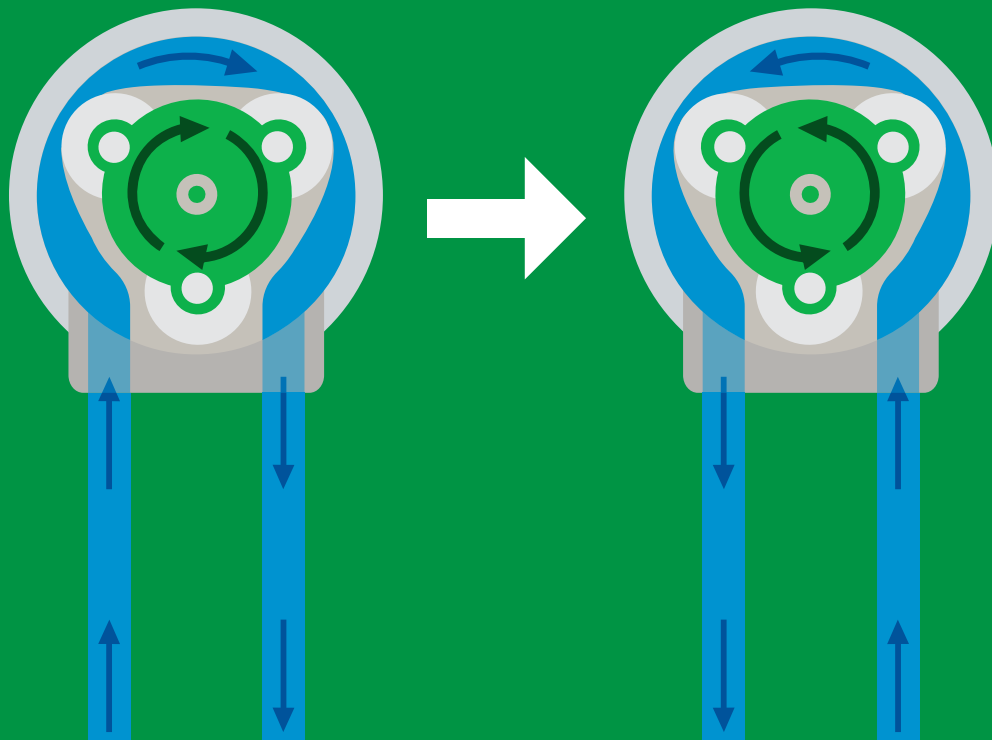

Total volume dispensed

Command syntax

TV,? <cr> shows total volume dispensed

ATV,? <cr> absolute value of the total volume dispensed

Clear <cr> clears the total dispensed volume

Example

Response

TV,? <cr>

?TV,434.50 <cr>

ATV,? <cr>

?ATV,623.00 <cr>

Clear <cr>

***OK <cr> total now 0.00**

This data will be lost if the power is cut.

Calibration

Command syntax

Calibrate to the actual volume dispensed.

Cal,v <cr> v = corrected volume

Cal,clear <cr> delete all calibration data

Cal,? <cr> device calibrated?

This command is used for both, single dose and dose over time calibrations.

Example

Response

Cal,24.01 <cr>

***OK** <cr>

Cal,clear <cr>

***OK** <cr>

Cal,? <cr>

?Cal,1 <cr> or **?Cal,2** <cr> or
fixed volume volume/time
?Cal,3 <cr> or **?Cal,0** <cr>
both uncalibrated
***OK** <cr>

Enable/disable parameters from output string

Command syntax

O, [parameter],[1,0] <cr> enable or disable output parameter
O,? <cr> enabled parameter?

Example

Response

O,V,1 <cr>

*OK <cr> enable volume being pumped

O,TV,0 <cr>

*OK <cr> disable total volume pumped

O,ATV,1 <cr>

*OK <cr> enable absolute volume pumped

O,? <cr>

?,O,V,TV,ATV <cr> if all three are enabled

Pump voltage

Command syntax

PV,? <cr> check pump voltage

Example

PV,? <cr>

Response

?PV,13.86 <cr>
***OK** <cr>

Response breakdown

?PV, 13.86

↑
Pump input voltage

Naming device

Command syntax

Do not use spaces in the name

Name,n <cr> set name

Name, <cr> clears name

Name,? <cr> show name

n =

1 2 3 4 5 6 7 8 9 10 11 12 13 14 15 16

Up to 16 ASCII characters

Example

Response

Name, <cr>

*OK <cr> name has been cleared

Name,zzt <cr>

*OK <cr>

Name,? <cr>

?Name,zzt <cr>
*OK <cr>

Name,zzt

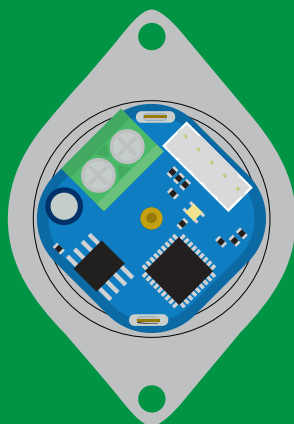

*OK <cr>

Name,?



?Name,zzt <cr>
*OK <cr>

Device information

Command syntax

```
i <cr> device information
```

Example

```
i <cr>
```

Response

```
?i,PMP,1.1 <cr>  
*OK <cr>
```

Response breakdown

```
?i, PMP, 1.1  
    ↑    ↑  
  Device Firmware
```

Response codes

Command syntax

- *OK,1** <cr> enable response **default**
- *OK,0** <cr> disable response
- *OK,?** <cr> response on/off?

Example

Response

R <cr>

413 <cr>
***OK** <cr>

***OK,0** <cr>

no response, ***OK** disabled

R <cr>

413 <cr> ***OK** disabled

***OK,?** <cr>

?*OK,1 <cr> or **?*OK,0** <cr>

Other response codes

- *ER** unknown command
- *OV** over volt ($VCC \geq 5.5V$)
- *UV** under volt ($VCC \leq 3.1V$)
- *RS** reset
- *RE** boot up complete, ready
- *SL** entering sleep mode
- *WA** wake up
- *DONE** dispensing complete
- *MINVOL** dispense amount too low
- *TOOFAST** ml/min set to fast

These response codes cannot be disabled

Reading device status

Command syntax

Status <cr> voltage at Vcc pin and reason for last restart

Example

```
Status <cr>
```

Response

```
?Status,P,5.038 <cr>  
*OK <cr>
```

Response breakdown

?Status,	P,	5.038
	↑	↑
	Reason for restart	Voltage at Vcc

Restart codes

P	powered off
S	software reset
B	brown out
W	watchdog
U	unknown

Sleep mode/low power

Command syntax

Send any character or command to awaken device.

Sleep <cr> enter sleep mode/low power

Example

Response

Sleep <cr>

*OK <cr>

*SL <cr>

Any command

*WA <cr> wakes up device

5V

STANDBY	SLEEP
13.4 mA	0.415 mA

3.3V

12.4 mA	0.13 mA
---------	---------

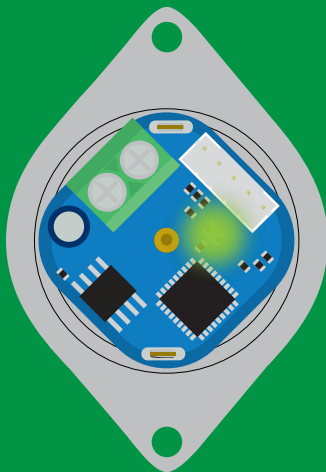

Standby
13.4 mA

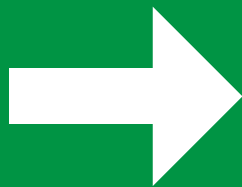

Sleep <cr>

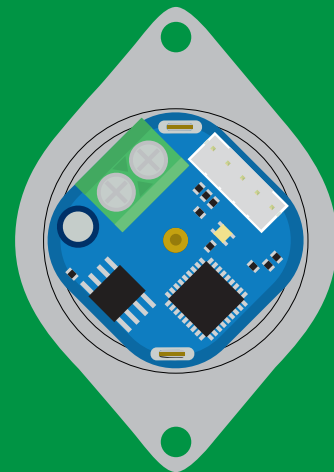

Sleep
0.415 mA

Change baud rate

Command syntax

Baud,n <cr> change baud rate

Example

Baud,38400 <cr>

Response

*OK <cr>

Baud,? <cr>

?Baud,38400 <cr>

*OK <cr>

n =

- 300
- 1200
- 2400
- 9600 default**
- 19200
- 38400
- 57600
- 115200



Standby

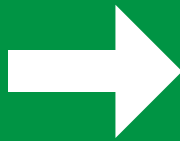

Baud,38400 <cr>



Changing
baud rate

*OK <cr>

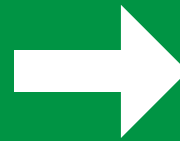

(reboot)



Standby

Protocol lock

Command syntax

Locks device to UART mode.

Plock,1 <cr> enable Plock

Plock,0 <cr> disable Plock **default**

Plock,? <cr> Plock on/off?

Example

Response

Plock,1 <cr>

***OK** <cr>

Plock,0 <cr>

***OK** <cr>

Plock,? <cr>

?Plock,1 <cr> **or** **?Plock,0** <cr>

Plock,1

I2C,100

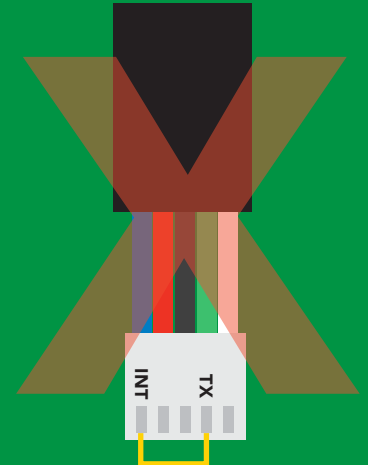

***OK** <cr>

cannot change to I²C

cannot change to I²C

***ER** <cr>

Factory reset

Command syntax

Clears calibration
LED on
"*OK" enabled

Factory <cr> enable factory reset

Example

Response

Factory <cr>

*OK <cr>

Factory <cr>

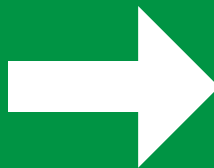

(reboot)



*OK <cr>

*RS <cr>

*RE <cr>

Baud rate will not change

Change to I²C mode

Command syntax

Default I²C address 103 (0x67)

I2C,n <cr> sets I²C address and reboots into I²C mode

n = any number 1 – 127

Example

Response

I2C,100 <cr>

*OK (reboot in I²C mode)

Wrong example

Response

I2C,139 <cr> n ≠ 127

*ER <cr>

I2C,100



Green
*OK <cr>

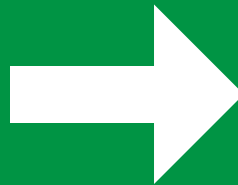

(reboot)



Blue
now in I²C mode

Manual switching to I²C

- Disconnect ground (power off)
- Disconnect TX and RX
- Connect TX to INT
- Confirm RX is disconnected
- Connect ground (power on)
- Wait for LED to change from **Green** to **Blue**
- Disconnect ground (power off)
- Reconnect all data and power

Manually switching to I²C will set the I²C address to 103 (0x67)

Example

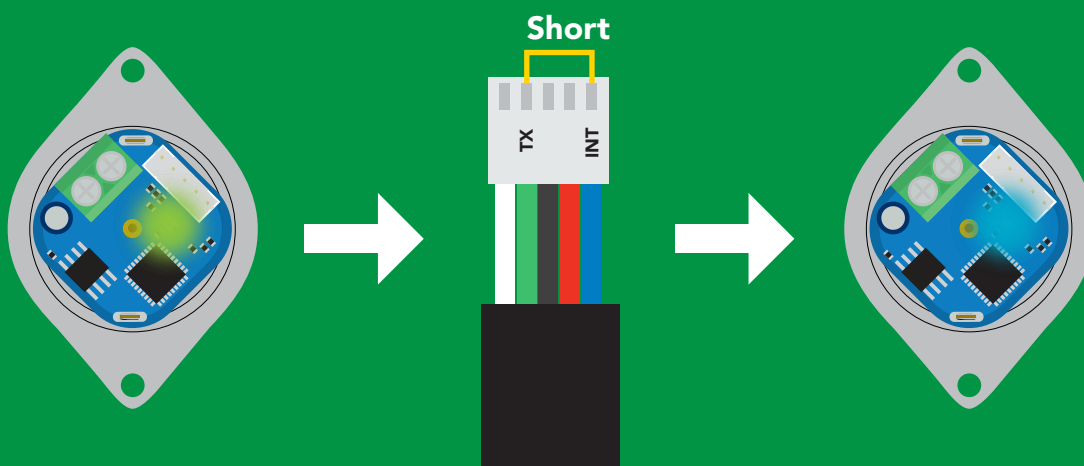

Wrong Example

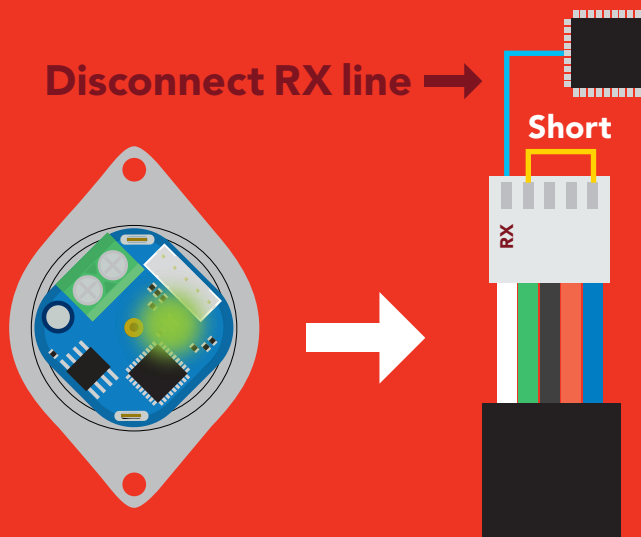

I²C mode

The I²C protocol is **considerably more complex** than the UART (RS-232) protocol. Atlas Scientific assumes the embedded systems engineer understands this protocol.

To set your EZO-PMP™ into I²C mode click [here](#)

Settings that are retained if power is cut

- Calibration
- Change I²C address
- Enable/disable parameters
- Hardware switch to UART mode
- Invert
- LED control
- Protocol lock
- Software switch to UART mode

Settings that are **NOT** retained if power is cut

- Absolute total volume
- Find
- Sleep mode
- Total volume

I²C mode

I²C address (0x01 – 0x7F)
103 (0x67) default

Vcc 3.3V – 5.5V

Clock speed 100 – 400 kHz

SDA 

SCL 



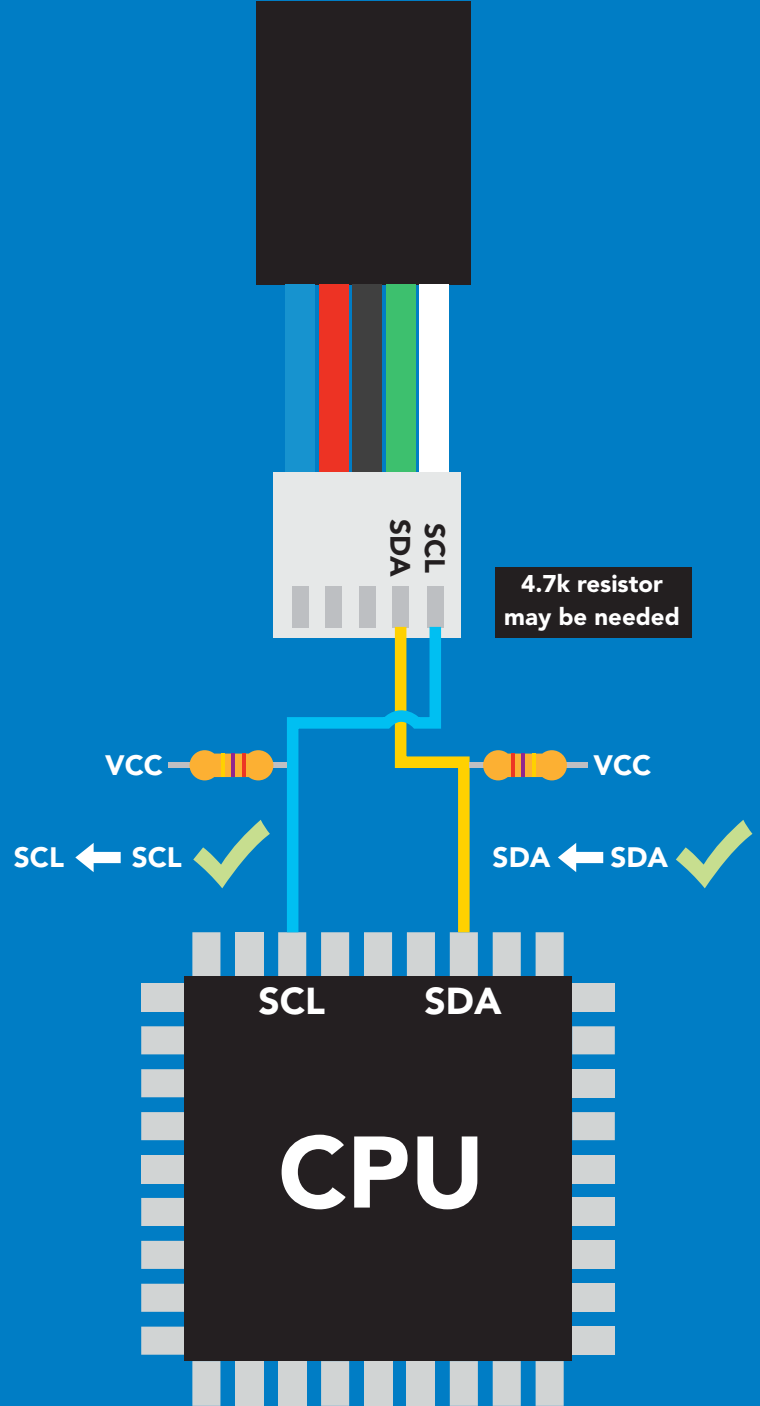

Data format

Reading volume

Units ml

Encoding ASCII

Format string

Data type floating point

Decimal places 2

Smallest string 3 characters

Largest string 39 characters

Sending commands to device



Example

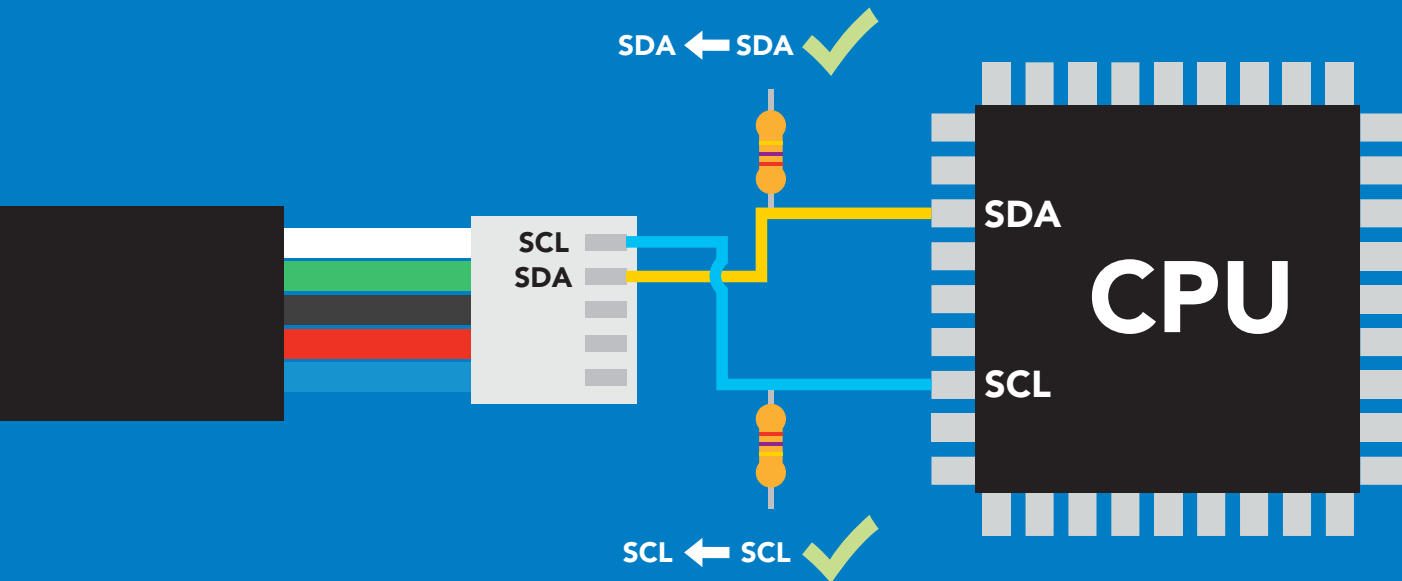

Advanced

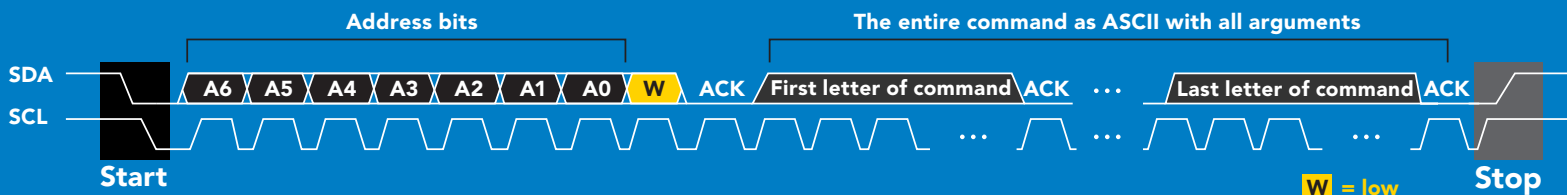

Requesting data from device

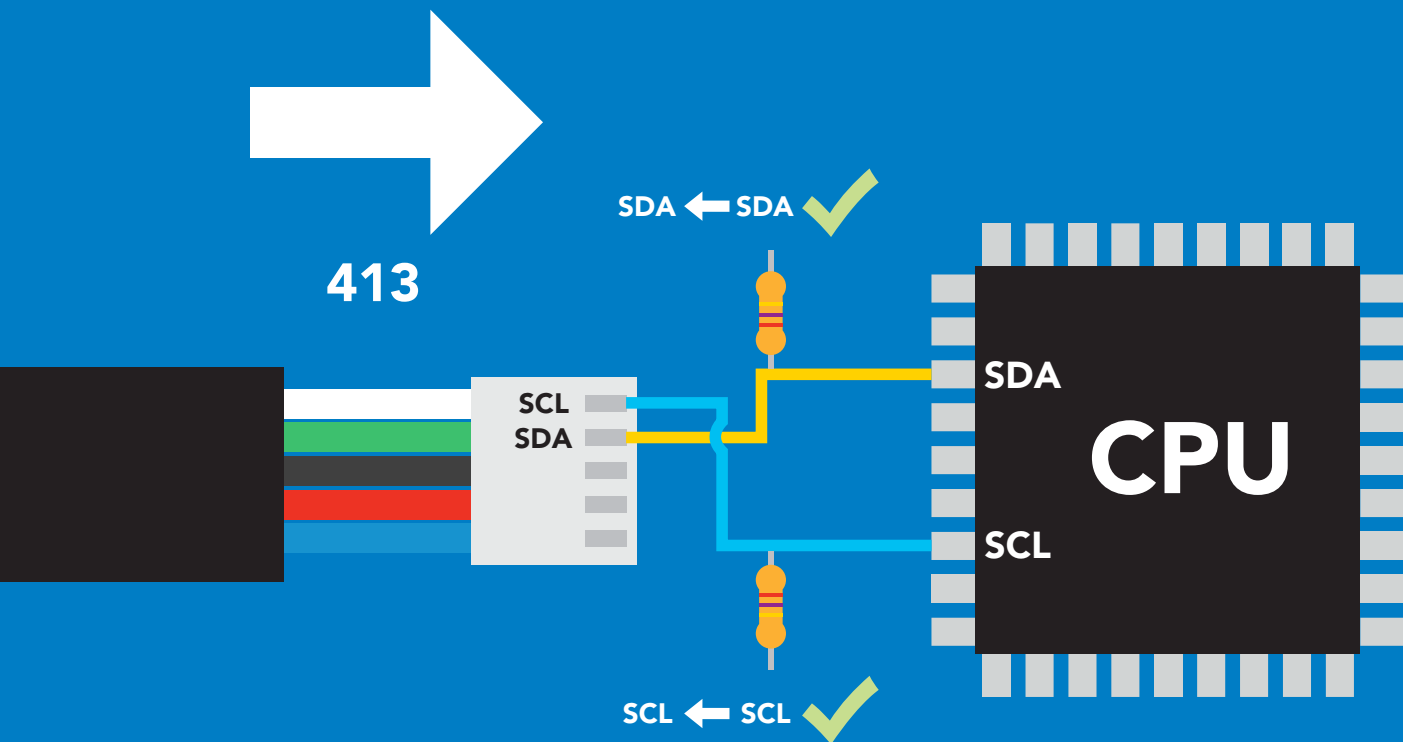
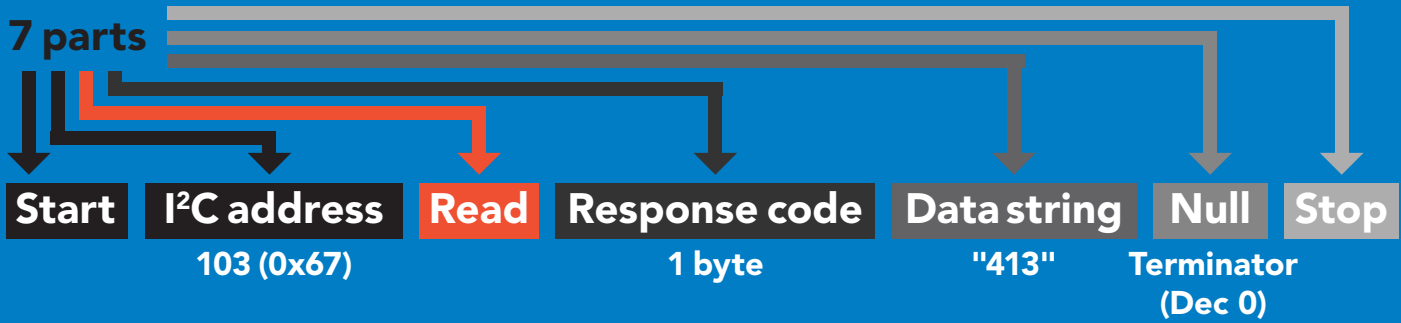

Advanced

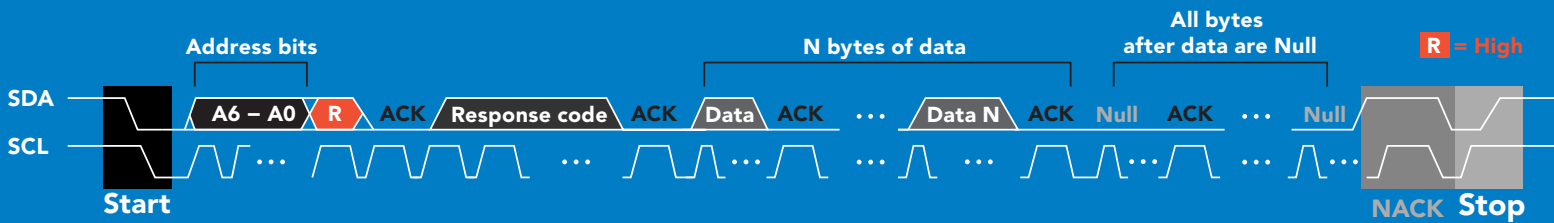

1 52 49 51 0 = 413

Dec ASCII Dec

Response codes

After a command has been issued, a 1 byte response code can be read in order to confirm that the command was processed successfully.

Reading back the response code is completely optional, and is not required for normal operation.

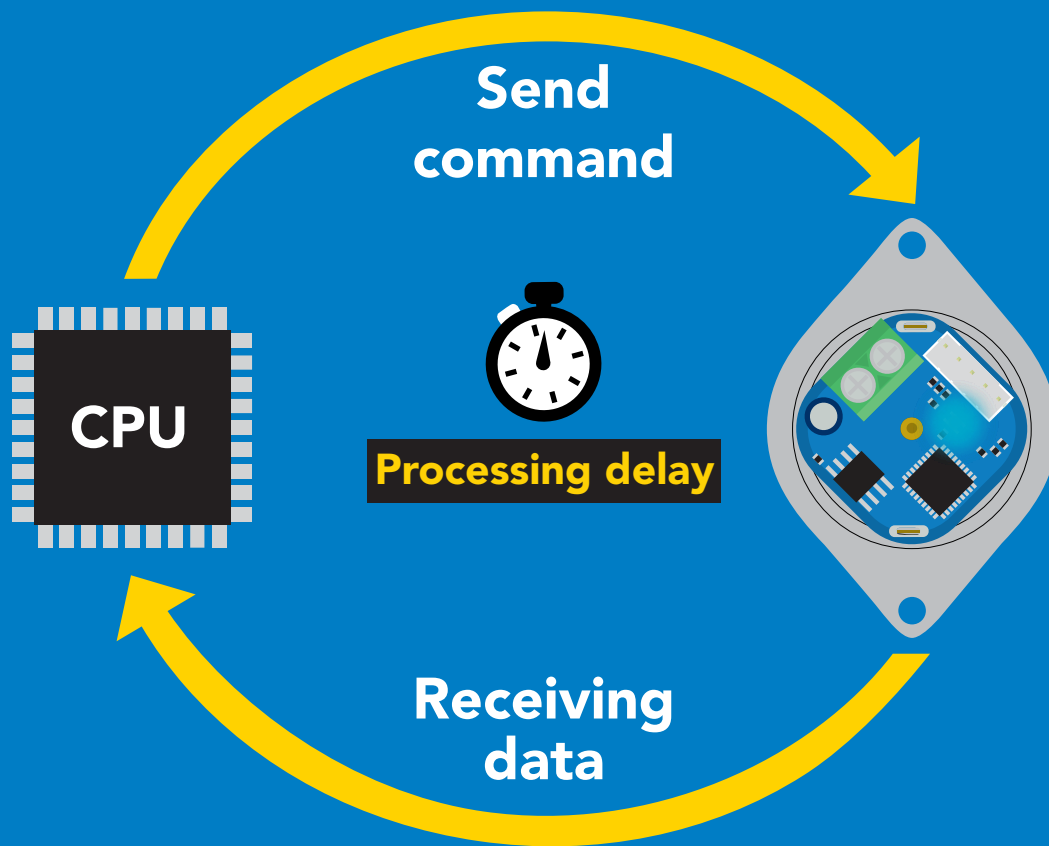

Example

```
I2C_start;  
I2C_address;  
I2C_write(EZO_command);  
I2C_stop;
```

```
delay(300);
```



```
Processing delay
```

```
I2C_start;  
I2C_address;  
Char[ ] = I2C_read;  
I2C_stop;
```

If there is no processing delay or the processing delay is too short, the response code will always be 254.

Response codes

Single byte, not string

255	no data to send
254	still processing, not ready
2	syntax error
1	successful request

LED color definition

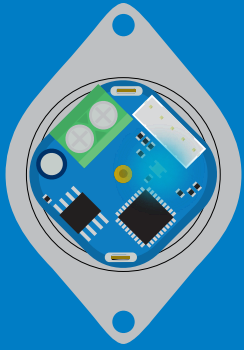

Blue

I²C standby

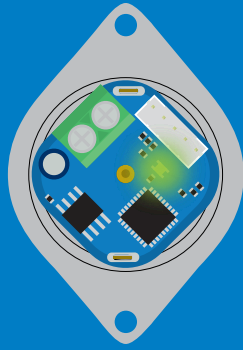

Green

Taking reading

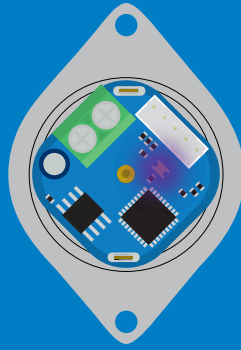

Purple

Changing
I²C address

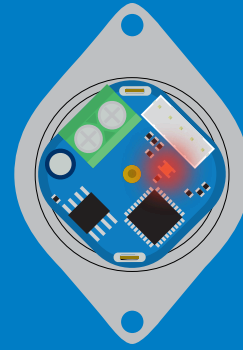

Red

Command
not understood



White

Find

5V

LED ON
+2.5 mA

3.3V

+1 mA

I²C mode

command quick reference

All commands are ASCII strings or single ASCII characters.

Command	Function	
Baud	switch back to UART mode	pg. 75
Cal	performs calibration	pg. 65
D	dispense modes	pg. 54 – 60
Factory	enable factory reset	pg. 74
Find	finds device with blinking white LED	pg. 52
i	device information	pg. 69
Invert	invert dispensing direction	pg. 63
I2C	change I ² C address	pg. 73
L	enable/disable LED	pg. 51
Name	set/show name of device	pg. 68
O	enable/disable parameters	pg. 66
P	pauses the pump during dispensing	pg. 61
Plock	enable/disable protocol lock	pg. 72
Pv	check pump voltage	pg. 67
R	returns a single reading	pg. 53
Sleep	enter sleep mode/low power	pg. 71
Status	retrieve status information	pg. 70
Tv	total volume dispensed	pg. 64
X	stop dispensing	pg. 62

LED control

Command syntax

300ms  processing delay

L,1 LED on **default**

L,0 LED off

L,? LED state on/off?

Example

Response

L,1



Wait 300ms **1** **0**
Dec Null

L,0

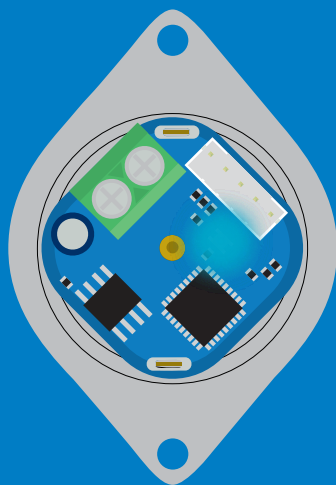

Wait 300ms **1** **0**
Dec Null

L,?

Wait 300ms **1** **?L,1** **0** or 
Dec ASCII Null **Wait 300ms** **1** **?L,0** **0**
Dec ASCII Null

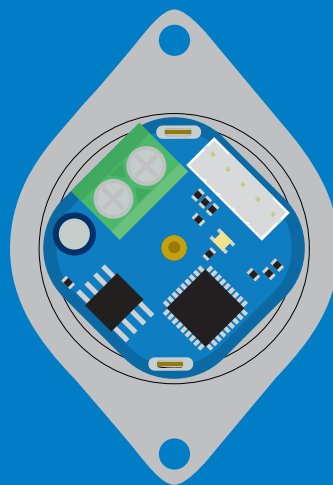

L,1



L,0

Find

300ms  processing delay

Command syntax

This command will disable continuous mode
Send any character or command to terminate find.

Find LED rapidly blinks white, used to help find device

Example

Response

Find

Wait 300ms

1
Dec

0
Null

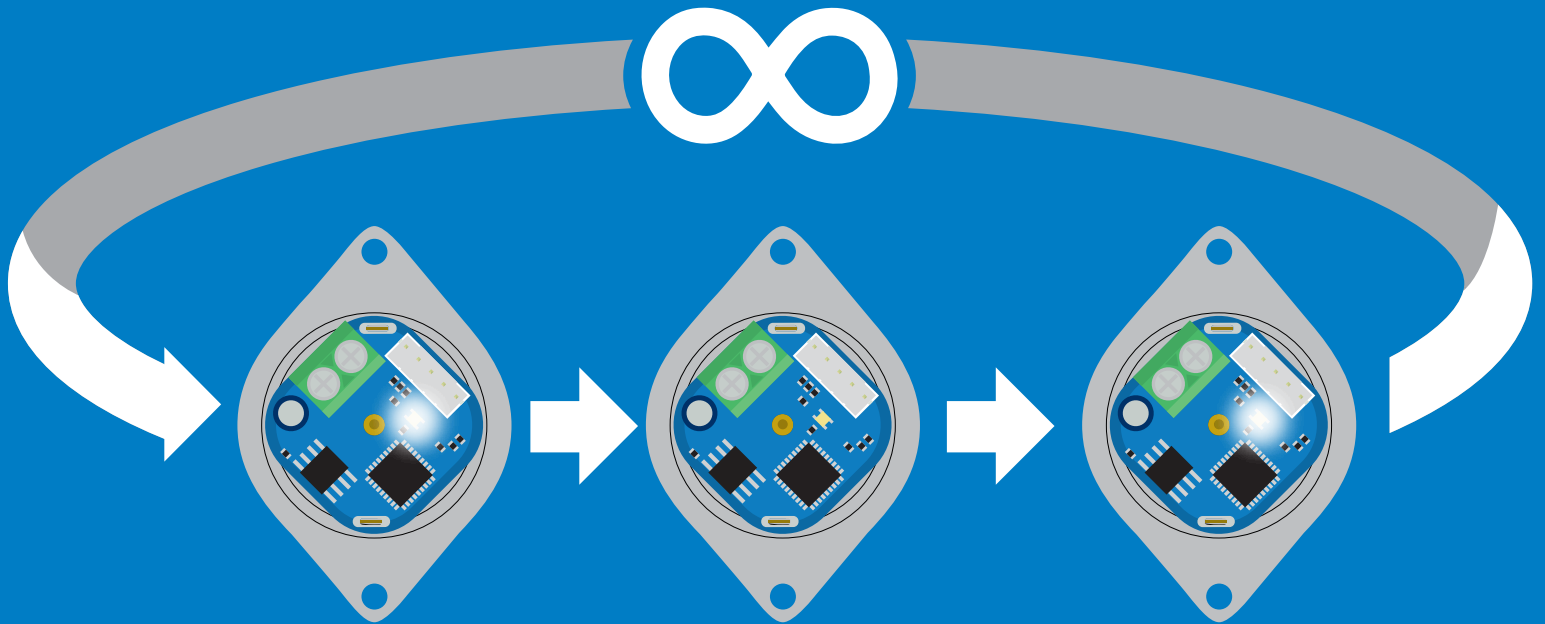

Single report mode

Command syntax

300ms  processing delay

R returns a single value showing dispensed volume

Example

R

Response



1	2.50	0
Dec	ASCII	Null

(If issued half way through dispensing 5ml)



1	5.00	0
Dec	ASCII	Null

(If issued once dispensing has stopped)

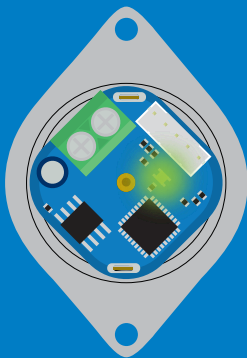

Green

Taking reading

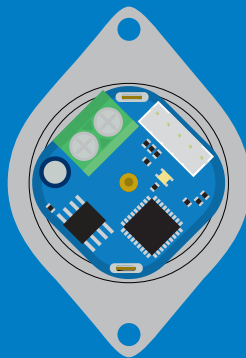
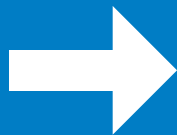

Transmitting

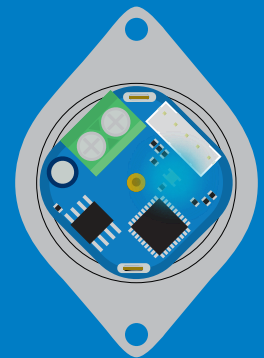

Blue

Standby

Continuous dispensing

Pump on/pump off

300ms  processing delay

Command syntax

After running in continuous mode for 20 days the EZO-PMP™ will reset.

D,* dispense until the stop command is given

D,-* dispense in reverse until the stop command is given

D,? dispense status

Example

Response

D,*



1
Dec

0
Null

pump will continuously run at ~105ml/min (with supplied tubing)

D,-*



1
Dec

0
Null

pump will continuously run in reverse at ~105ml/min (with supplied tubing)

D,?



1
Dec

?D,10.00,1
ASCII

0
Null

Response breakdown

?D,* ,1

↑ ↑
last volume pump on
requested

Volume dispensing

Pump a specific volume

300ms  processing delay

Command syntax

where [ml] is any volume in millimeters ≥ 0.5

- D,[ml] dispense [this specific volume]
- D,[-ml] dispense [*in reverse* this specific volume]
- D,? dispense status

Example

Response

D,15



1 **0**
Dec Null

15 ml will be dispensed

D,-40.5



1 **0**
Dec Null

40.5 ml will be dispensed
in reverse

D,?



1 **?D,-40.50,0** **0**
Dec ASCII Null

Response breakdown

?D,-40.50,0

↑ last volume dispensed
↑ pump off

Dose over time

Pump a fixed volume over a fixed time

Command syntax

300ms  processing delay

D,[ml],[min] Dispense [this volume], [over this many minutes]

Example

Response

D,85,10

Wait 300ms

1
Dec

0
Null

Dispense 85ml over 10 mins



Constant flow rate

Maintain a constant flow rate

300ms  processing delay

Command syntax

After running in continuous mode for 20 days the EZO-PMP™ will reset.

DC,[ml/min], [min or *] [maintain this rate], [for this much time]

DC,? reports maximum possible flow rate

[ml/min] = a single number (int or float) representing the desired flow rate

[min or *] = the number of minutes to run or (*) indefinitely

A negative value for ml/min = reverse

Example

Response

DC,25,40

Wait 300ms

1 0
Dec Null

Dispense 25ml per minute
for 40 minutes

DC,?



Wait 300ms

1 ?maxrate,58.5 0
Dec ASCII Null

The maximum flow rate is determined after calibration.
If the flowrate entered is too fast the EZO-PMP™ will send an error.

*TOOFAST

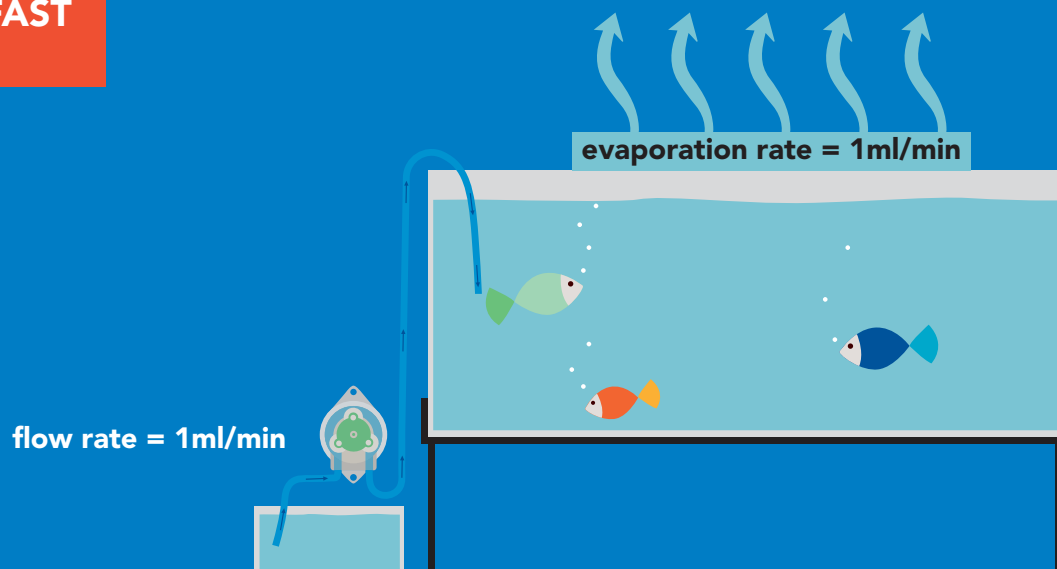
*ER



Dispense at startup

Pump a specific volume at startup and then stop

Use this command to make a simple fixed-volume pump

Command syntax

300ms  processing delay

Dstart,[ml] dispense [this specific volume] at startup
Dstart,off disables dispense at startup mode
Dstart,? startup dispense status

Example

Response

Dstart,10

 Wait 300ms
1 Dec 0 Null

Dstart,off

 Wait 300ms
1 Dec 0 Null

D,?

 Wait 300ms 1 Dec ?Dstart,10 0 Null or  Wait 300ms 1 Dec ?Dstart,0 0 Null

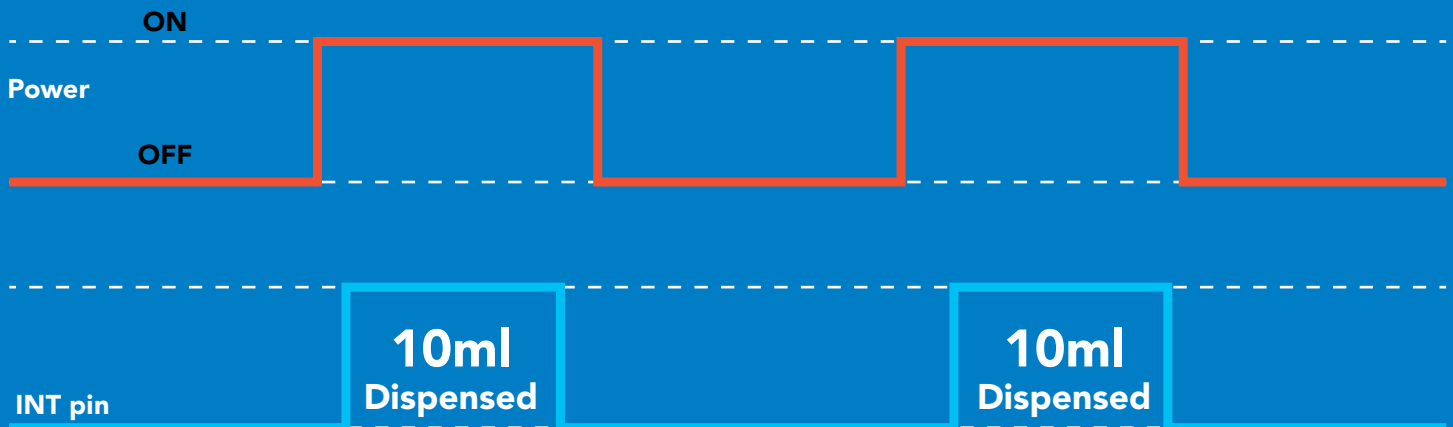

Continuous dispensing at startup

Pump on & continuously dispense

300ms  processing delay

Command syntax

After running in continuous mode for 20 days the EZO-PMP™ will reset.

- Dstart,*** dispense at startup until the stop command is given
- Dstart,-*** dispense in reverse at startup until the stop command is given
- Dstart,?** startup dispense status

Example

Response

Dstart,*



1 **0**
Dec Null

Pump will startup and continuously run at ~105ml/min (with supplied tubing)

Dstart,-*



1 **0**
Dec Null

Pump will startup and continuously run in reverse at ~105ml/min (with supplied tubing)

Dstart,?



1 **?Dstart,*** **0**
Dec ASCII Null

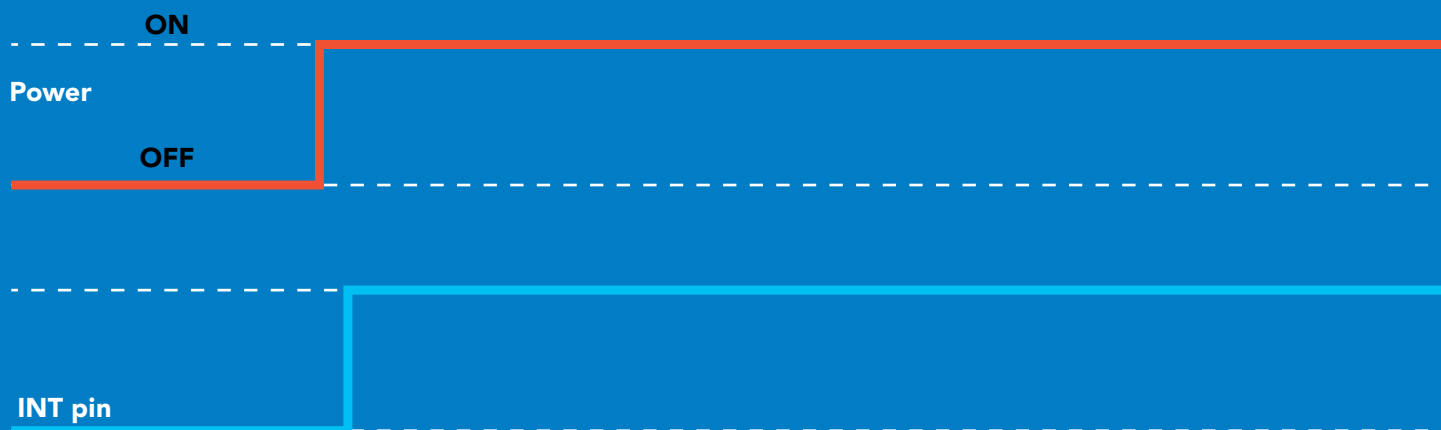

Dose Over time at startup

Pump a fixed volume over a fixed time at startup

Command syntax

300ms  processing delay

D,[ml],[min] Dispense [this volume], [over this many minutes] at startup

Example

Response

Dstart,85,10

Wait 300ms

1 **0**
Dec Null

Pump will startup and dispense 85ml over 10 minutes

Dstart,?

Wait 300ms

1 **?Dstart,85.00,10.00** **0**
Dec ASCII Null



Pause dispensing

300ms  processing delay

Command syntax

Issue the command again to resume dispensing

P pauses the pump during dispensing

P,? pause status

Example

Response

P

 **Wait 300ms** **1** **0**
Dec Null

P,?

 **Wait 300ms** **1** **?P,1** **0** or  **Wait 300ms** **1** **?P,0** **0**
Dec ASCII Null Dec ASCII Null
paused unpaused



dispensing

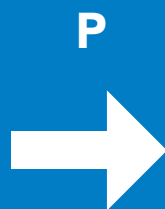

paused

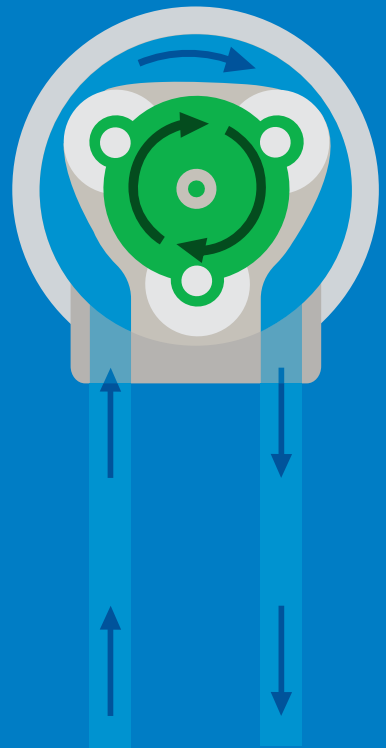
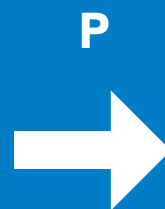

dispensing

Stop dispensing

Command syntax

300ms  processing delay

X stop dispensing

Example

Response

X



Wait 300ms

1
Dec

***DONE,v**
ASCII

0
Null

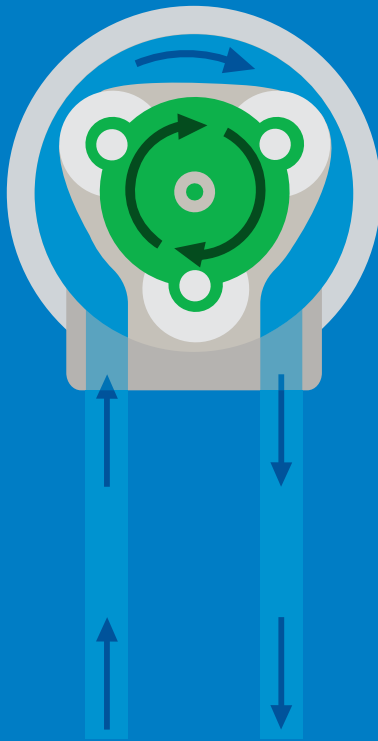
v = volume dispensed



X
dispensing

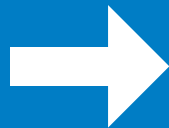

***DONE,10.15**
Stopped

Invert dispensing direction

300ms  processing delay

Command syntax

Invert direction will be retained if power is cut

Invert changes dispensing direction of pump

Example

Invert

 **Wait 300ms** **1** **0**
Dec Null

Invert,?

 **Wait 300ms** **1** **?Invert,1** **0** or  **Wait 300ms** **1** **?Invert,0** **0**
Dec ASCII Null Dec ASCII Null
inverted uninvverted

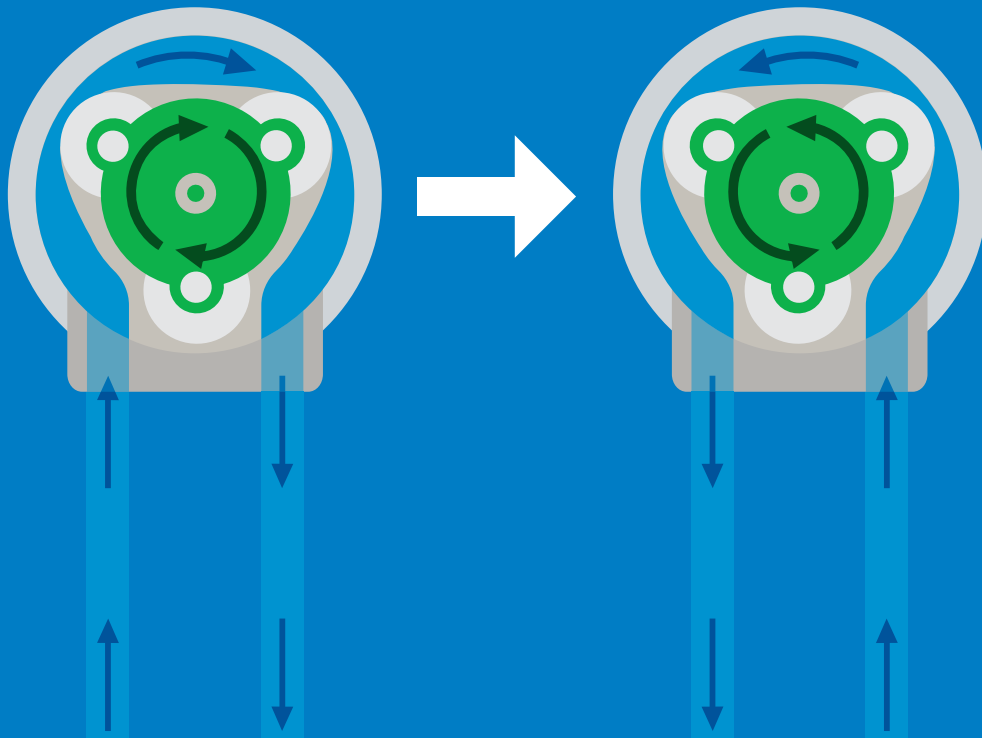

Total volume dispensed

Command syntax

300ms  processing delay

TV,? shows total volume dispensed

ATV,? absolute value of the total volume dispensed

Clear clears the total dispensed volume

Example

Response

TV,?

 **1** **?TV,623.00** **0**
Wait 300ms Dec ASCII Null

ATV,?

 **1** **?ATV,434.50** **0**
Wait 300ms Dec ASCII Null

clear

 **1** **0** **total now 0.00**
Wait 300ms Dec Null

This data will be lost if the power is cut.

Calibration

300ms  processing delay

Command syntax

Calibrate to the actual volume dispensed.

Cal,v v = corrected volume
Cal,clear delete calibration data
Cal,? device calibrated?

Example

Response



Cal,24.01



 **Wait 300ms** **1** **0**
Dec Null

Cal,clear

 **Wait 300ms** **1** **0**
Dec Null

Cal,?

 **Wait 300ms** **1** **?Cal,1** **0** or  **Wait 300ms** **1** **?Cal,2** **0**
Dec ASCII Null Dec ASCII Null
fixed volume volume/time

 **Wait 300ms** **1** **?Cal,3** **0** or  **Wait 300ms** **1** **?Cal,0** **0**
Dec ASCII Null Dec ASCII Null
both uncalibrated

Enable/disable parameters from output string

Command syntax

300ms  processing delay

O, [parameter],[1,0] enable or disable output parameter
O,? enabled parameter?

Example

Response

O,V,1

 **Wait 300ms** **1** **0**
Dec Null

enable volume being pumped

O,TV,0

 **Wait 300ms** **1** **0**
Dec Null

disable total volume pumped

O,ATV,1

 **Wait 300ms** **1** **0**
Dec Null

enable absolute volume pumped

O,?

 **Wait 300ms** **1** **?O,V,TV,ATV** **0**
Dec ASCII Null

if all three are enabled

Pump voltage

Command syntax

300ms  processing delay

PV,? check pump voltage

Example

Response

PV,?



Wait 300ms

1

Dec

?PV,13.86

ASCII

0

Null

Response breakdown

?PV, 13.86



Pump input voltage

Naming device

300ms  processing delay

Command syntax

Do not use spaces in the name

Name,n	set name	n =	1	2	3	4	5	6	7	8	9	10	11	12	13	14	15	16
Name,	clears name		Up to 16 ASCII characters															
Name,?	show name																	

Example

Response

Name,



1 **0**
Dec Null

name has been cleared

Name,zzt



1 **0**
Dec Null

Name,?



1 **?Name,zzt** **0**
Dec ASCII Null

Name,zzt

Name,?

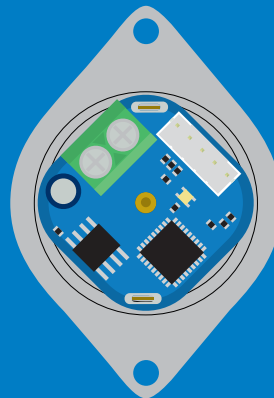
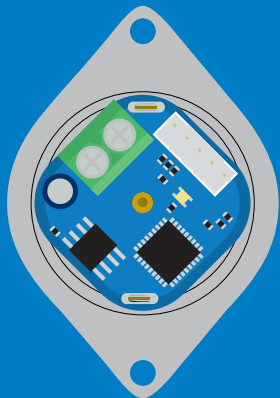

1 **0**

1 **?Name,zzt** **0**

Device information

Command syntax

300ms  processing delay

i device information

Example

i

Response



Wait 300ms

1

Dec

?i,PMP, 1.1

ASCII

0

Null

Response breakdown

?i, PMP, 1.1
↑ ↑
Device Firmware

Reading device status

Command syntax

300ms  processing delay

Status voltage at Vcc pin and reason for last restart

Example

Response

Status

 **1** **?Status,P,5.038** **0**
Wait 300ms Dec ASCII Null

Response breakdown

?Status, **P,** **5.038**
Reason for restart Voltage at Vcc

Restart codes

P powered off
S software reset
B brown out
W watchdog
U unknown

Sleep mode/low power

Command syntax

Sleep enter sleep mode/low power

Send any character or command to awaken device.

Example

Response

Sleep

no response

Do not read status byte after issuing sleep command.

Any command

wakes up device

5V

STANDBY	SLEEP
13.4 mA	0.415 mA

3.3V

12.4 mA	0.13 mA
----------------	----------------

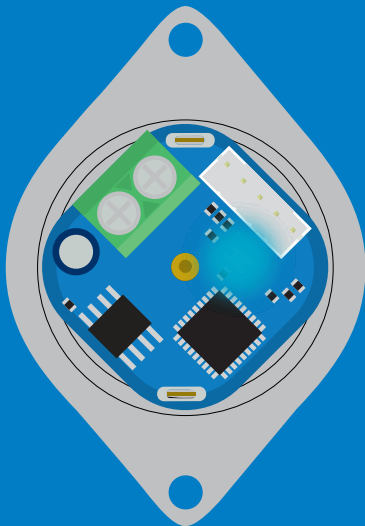

Standby

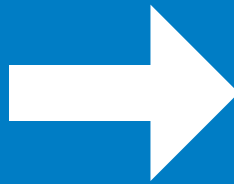

Sleep

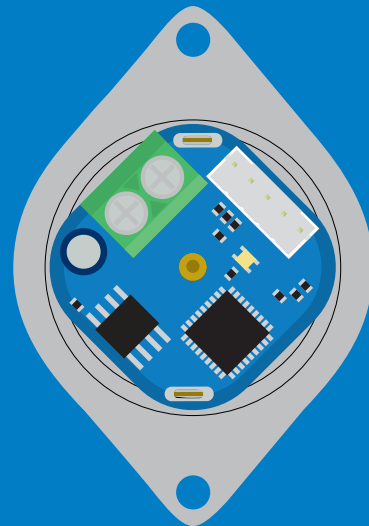

Sleep

Protocol lock

Command syntax

300ms  processing delay

Plock,1 enable Plock

Plock,0 disable Plock

Plock,? Plock on/off?

Locks device to I²C mode.

default

Example

Response

Plock,1

Wait 300ms

1	0
Dec	Null

Plock,0

Wait 300ms

1	0
Dec	Null

Plock,?



Wait 300ms

1	?Plock,1	0
Dec	ASCII	Null

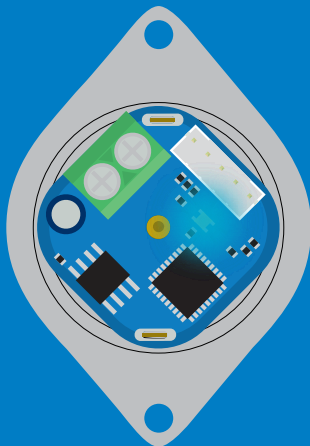
Plock,1

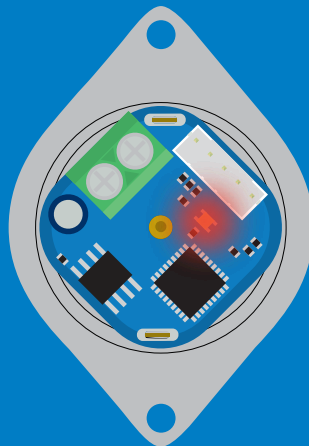

Baud, 9600



cannot change to UART

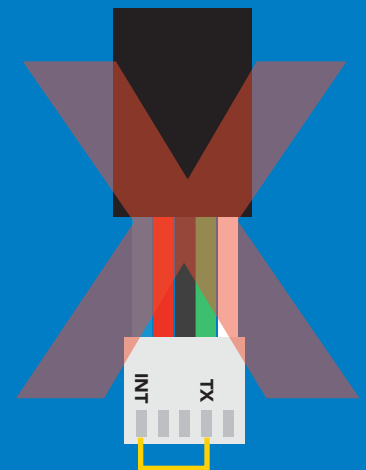

cannot change to UART

I²C address change

Command syntax

300ms  **processing delay**

I2C,n sets I²C address and reboots into I²C mode

Example

Response

I2C,101

device reboot
(no response given)

Warning!

Changing the I²C address will prevent communication between the circuit and the CPU until the CPU is updated with the new I²C address.

Default I²C address is 103 (0x67).

n = any number 1 – 127

I2C,101

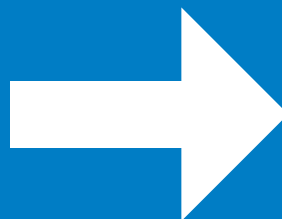
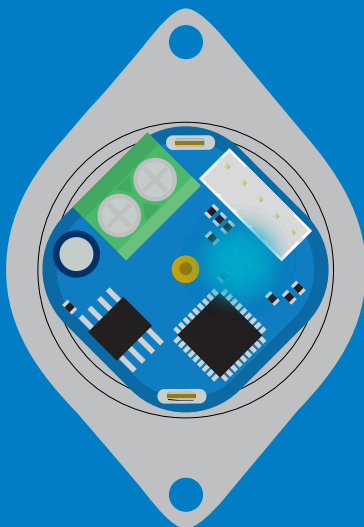

(reboot)

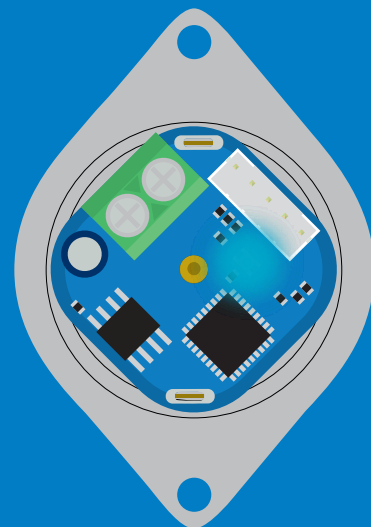

Factory reset

Command syntax

Factory reset will not take the device out of I²C mode.

Factory enable factory reset

I²C address will not change

Example

Response

Factory

device reboot
(no response given)

Clears calibration
LED on
Response codes enabled

Factory

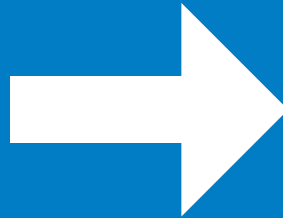
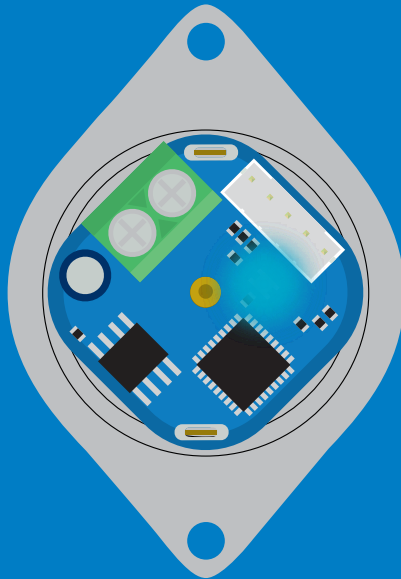

(reboot)

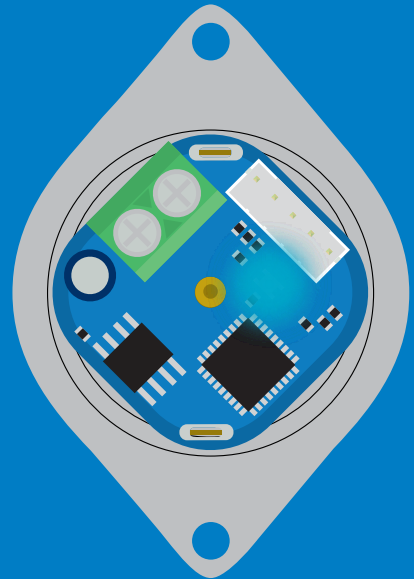

Change to UART mode

Command syntax

Baud,n switch from I²C to UART

Example

Baud,9600

Response

reboot in UART mode
(no response given)

n = [300
1200
2400
9600
19200
38400
57600
115200

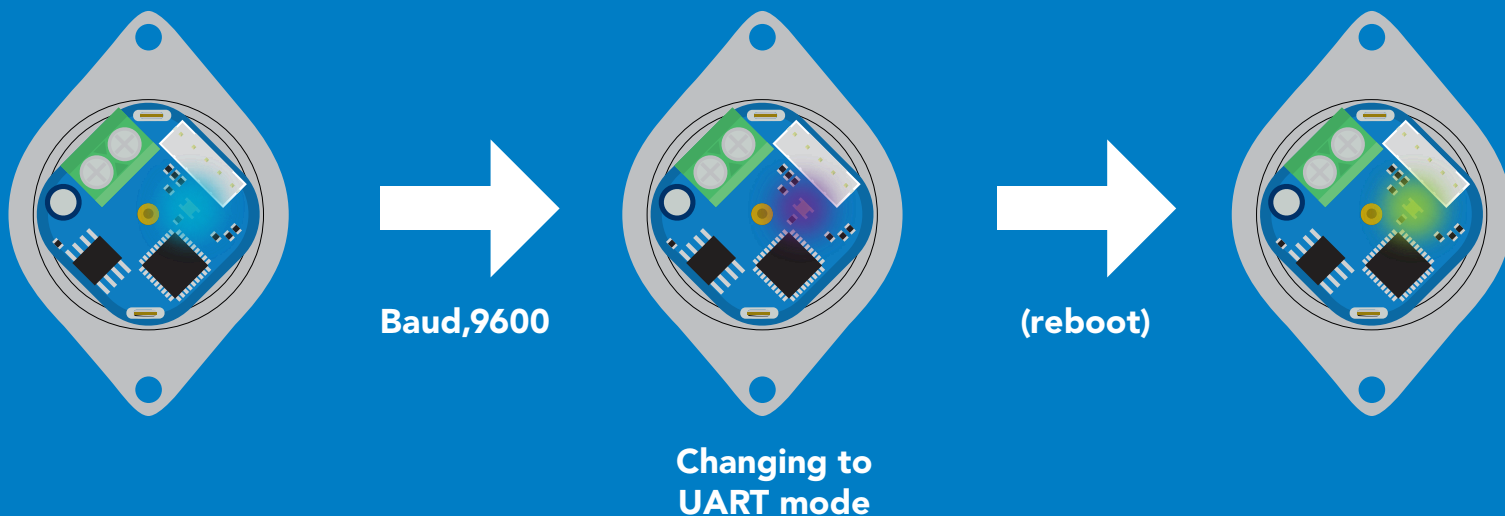

Manual switching to UART

- Disconnect ground (power off)
- Disconnect TX and RX
- Connect TX to INT
- Confirm RX is disconnected
- Connect ground (power on)
- Wait for LED to change from Blue to Green
- Disconnect ground (power off)
- Reconnect all data and power

Example

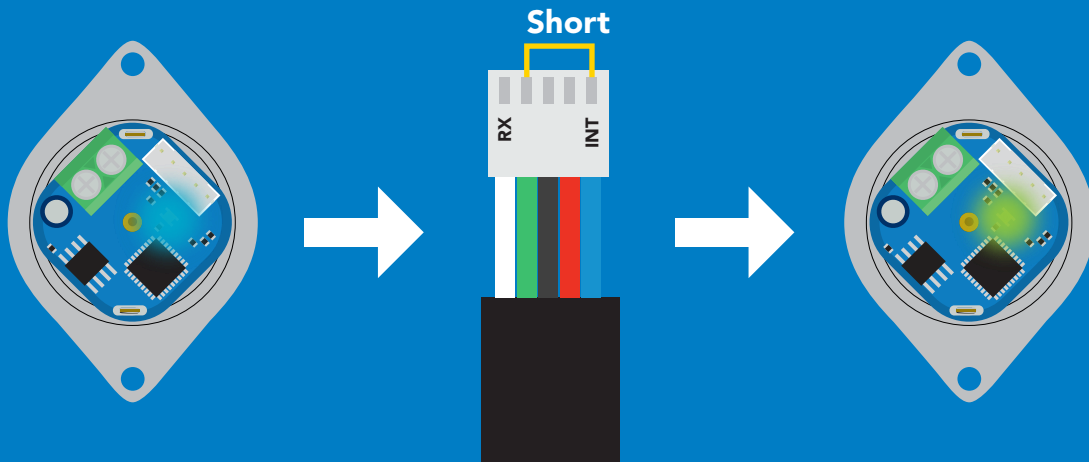

Wrong Example

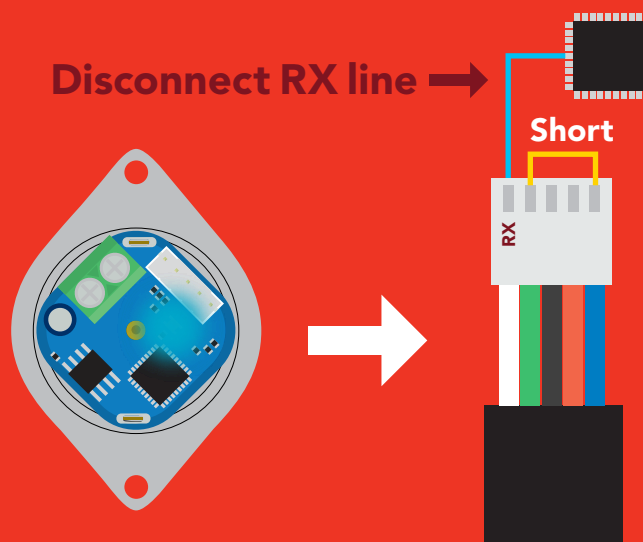

Calibration theory

Uncalibrated accuracy +/- 5%
Calibrated accuracy +/- 1%

Before calibration is attempted all the air bubbles should be removed from the tubing. This is done by running the pump while tapping the tubing. If air bubbles are not removed from the tubing they will slowly group together into larger air bubbles. Over time this will lead to accuracy issues.

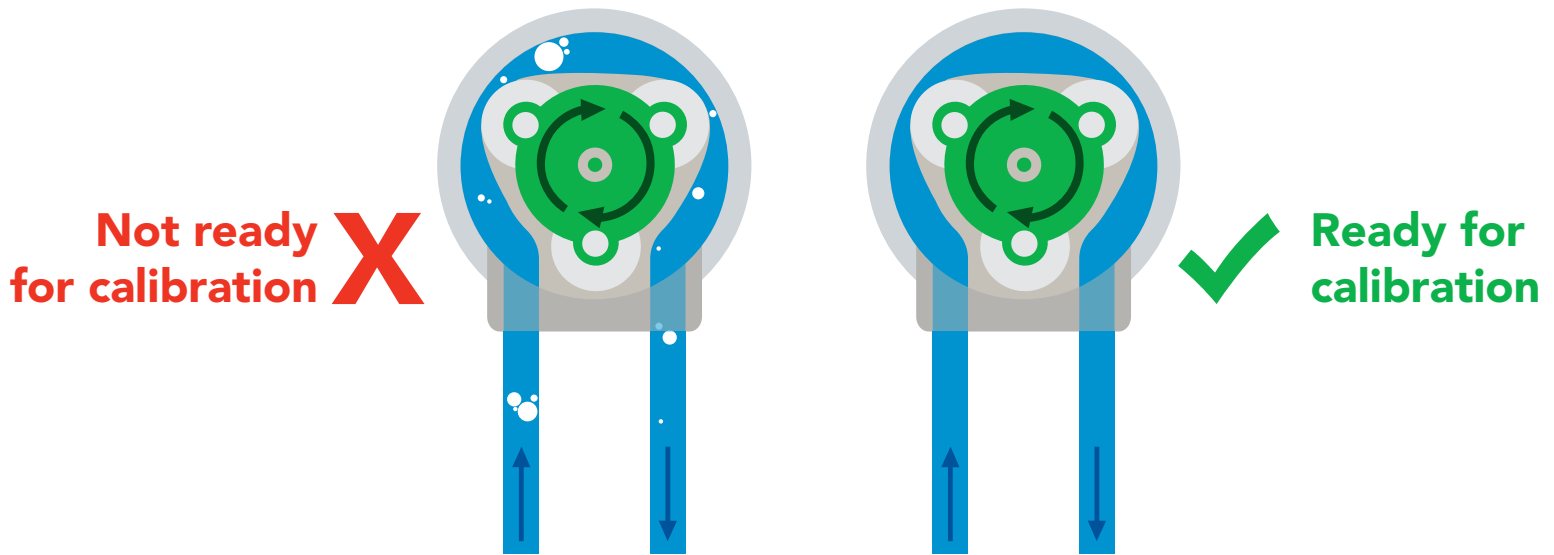

Calibration types

Volume calibration
Volume over time calibration

Calibration is optional. Both types of calibration are independent of each other and can be done at any time. Calibration can be done at any volume however; Atlas Scientific recommends using volumes above 5ml.

Equipment needed for calibration

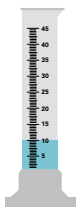

An accurate graduated cylinder of at least 10ml.

Or

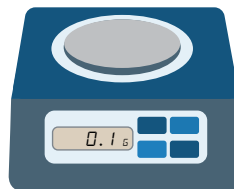

An accurate scale with a resolution of at least 0.1 grams

1 gram of water = 1ml
23.56 grams of water = 23.56ml

Calibration procedure

Calibration should be done with water and not a chemical

Make sure the tubing is full of water and has no bubbles before calibrating.

1. Instruct the pump to dispense a volume of water.
2. Measure the dispensed amount to determine how much water was actually dispensed.
3. Calibrate the pump by sending it the volume of liquid you have measured.

Example

Calibrate the pump by dispensing 10ml

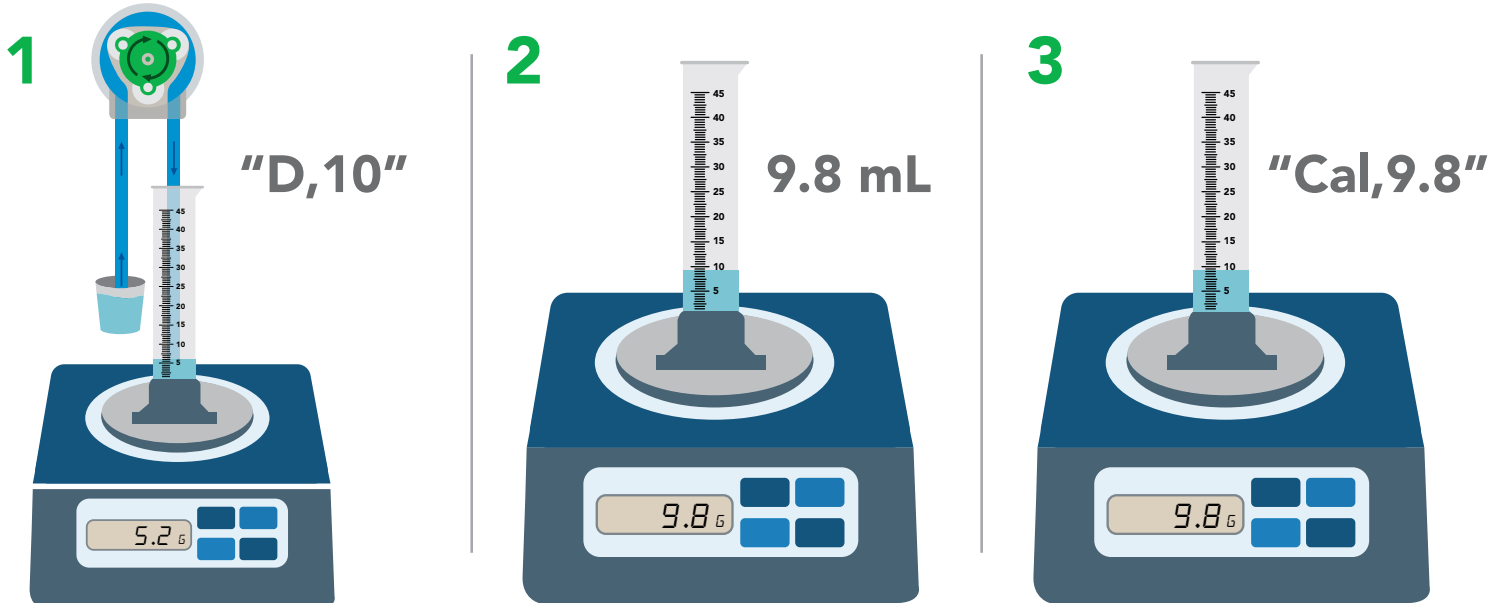

1. Instruct the pump to dispense 10ml into a graduated cylinder or beaker on a scale.
2. Measure the amount of liquid that was actually dispensed.
3. Inform the pump how much liquid was actually dispensed.
4. Calibration is now complete.

Once the pump has been calibrated, it will accurately dispense any volume of liquid. Use the same procedure to perform a volume over time calibration.

Pump speed vs. voltage

There is no change in pump speed at different voltages.

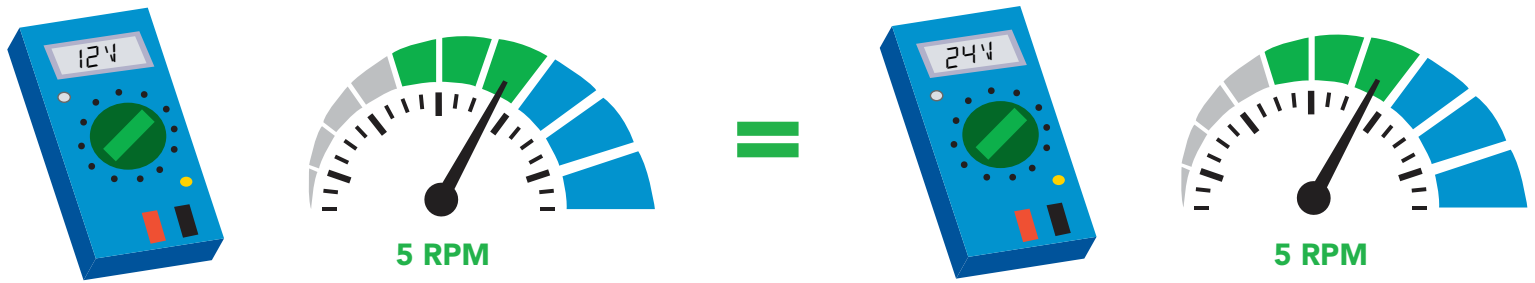

Interrupt pin

When the pump is dispensing the interrupt pin goes high.



Removing cassette

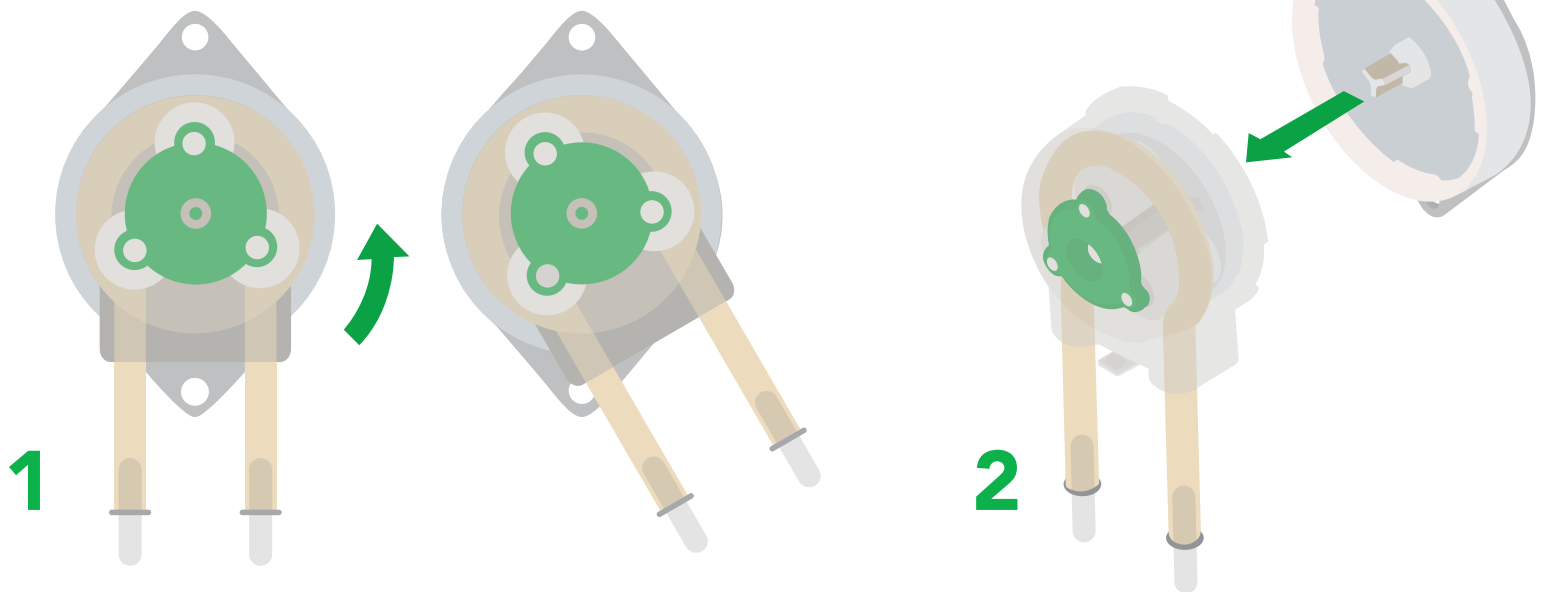

1 Turn cassette counterclockwise until it stops.

2 Pull cassette off the motor.

Removing tube assembly

The inner workings of the cassette are fragile and must be dismantled by hand. Using tools can damage or break the cassette.

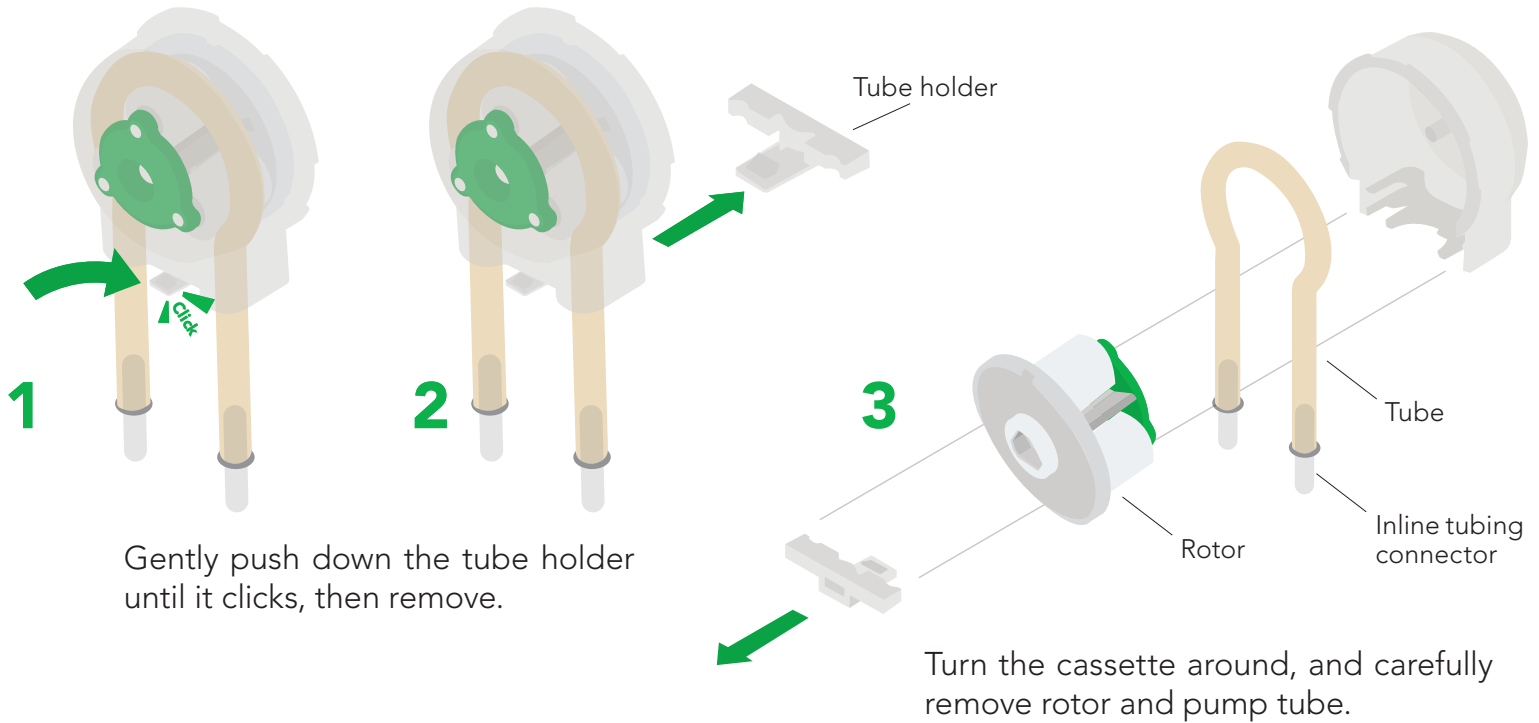

Installing new tube assembly



Measure 75mm of pump tubing, and mark both ends with a soft-tip pen or marker.

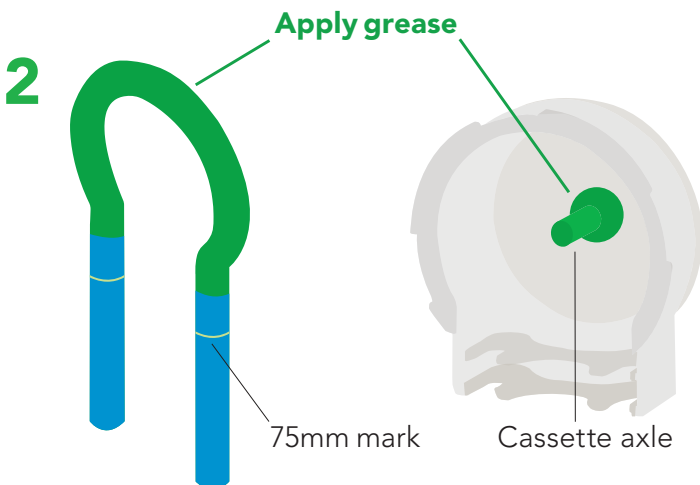

Apply silicone lubricating grease to the marked areas on both the tubing and cassette axle.

Do not operate this device without lubrication!

Atlas Scientific recommends using **Super Lube** silicone lubricating grease.



3

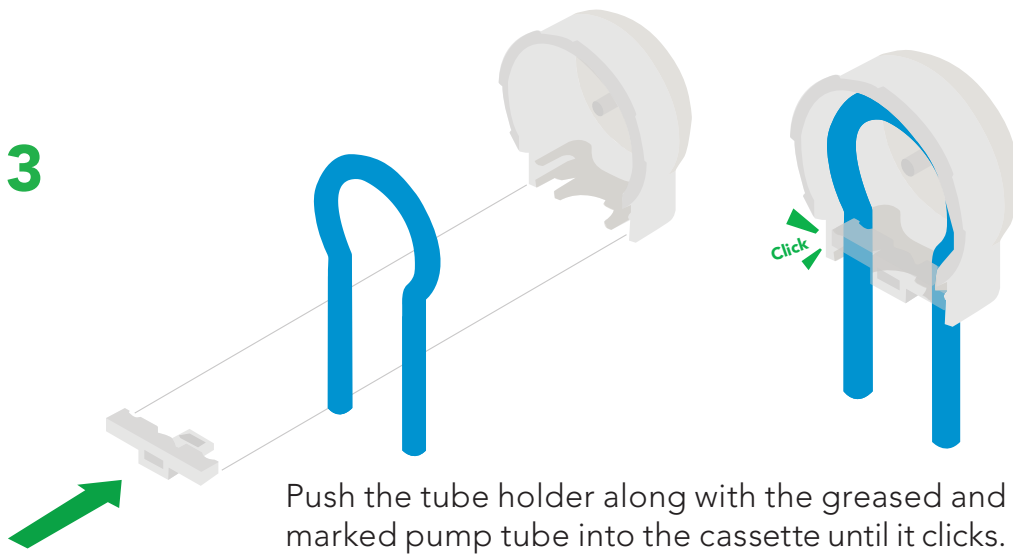

Push the tube holder along with the greased and marked pump tube into the cassette until it clicks.

4

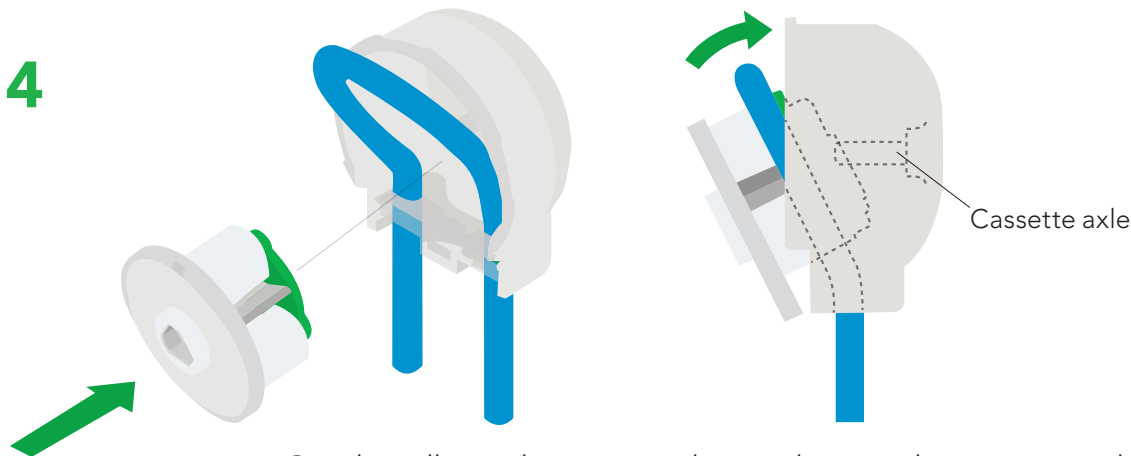

Gently pull out the pump tube, and insert the rotor into the pump tube. Align pump tube and rotor with the cassette axle.

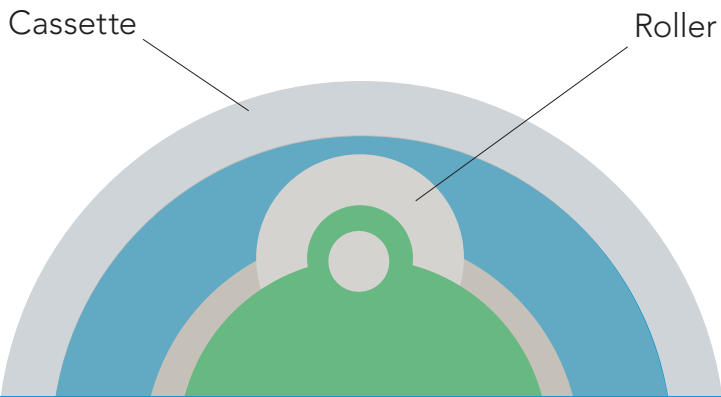

Make sure the pump tube is held between the roller and cassette.

✓ **Correct**



X Incorrect

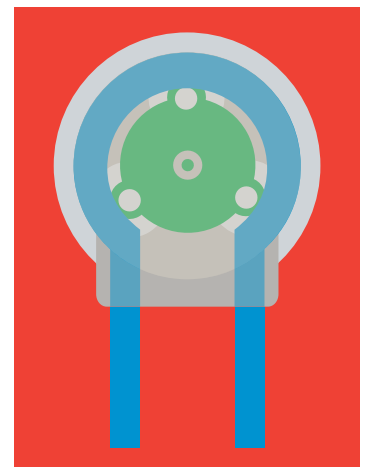

Once the tubing has been replaced, run the pump for 3–5 minutes to break in the new tubing. **Remember, this pump can be run dry and does not need to pump liquid for the 3–5 minute break in period.**

Accuracy

Uncalibrated accuracy +/- 5%
Calibrated accuracy +/- 1%

Volume dispensing mode

calibrated at 10ml

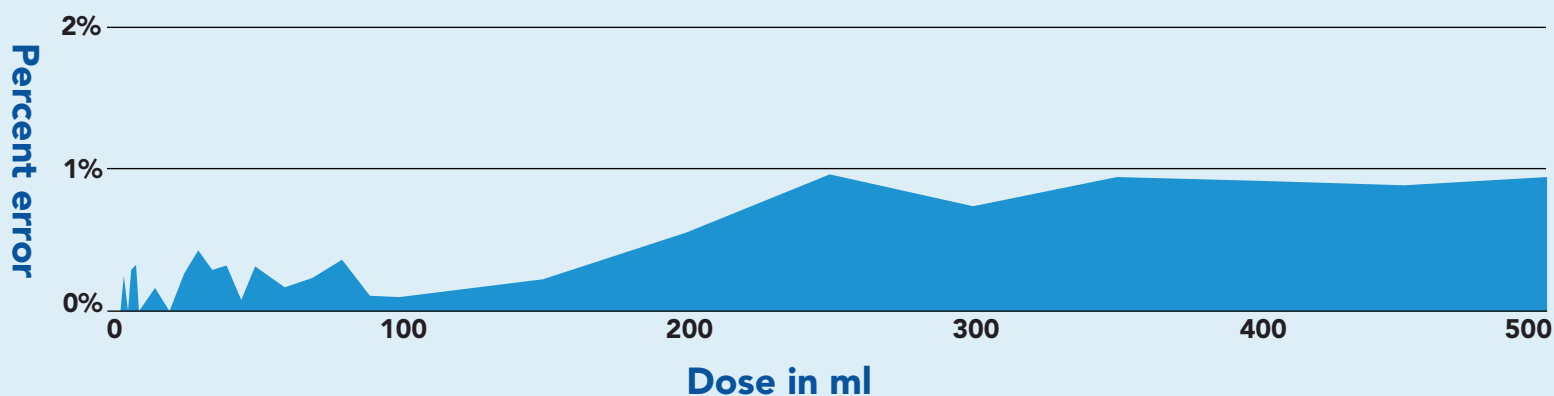

Dose over time mode

calibrated at 10ml over 90 seconds

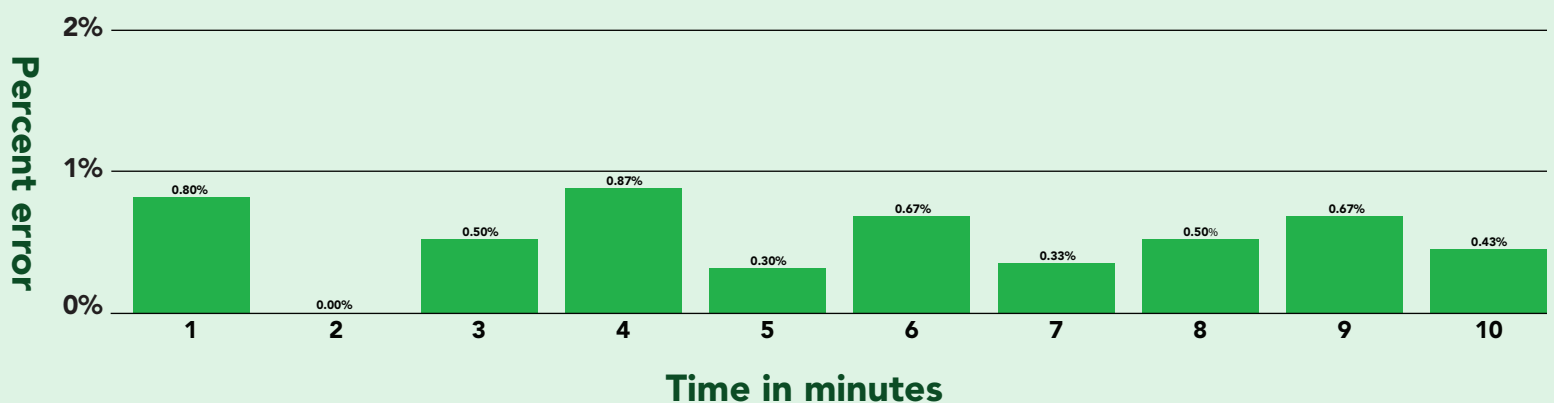

Viscosity

The EZO-PMP™ is capable of pumping liquids within a viscosity range of **0.1 – 2,000 cP**.

- 0.6 = Acetone
- 1 = Water
- 10 = Kerosene
- 100 = Corn Syrup
- 200 = Maple Syrup
- 2,000 = Honey
- 10,000 = Hershey Chocolate Syrup

Dispense accuracy

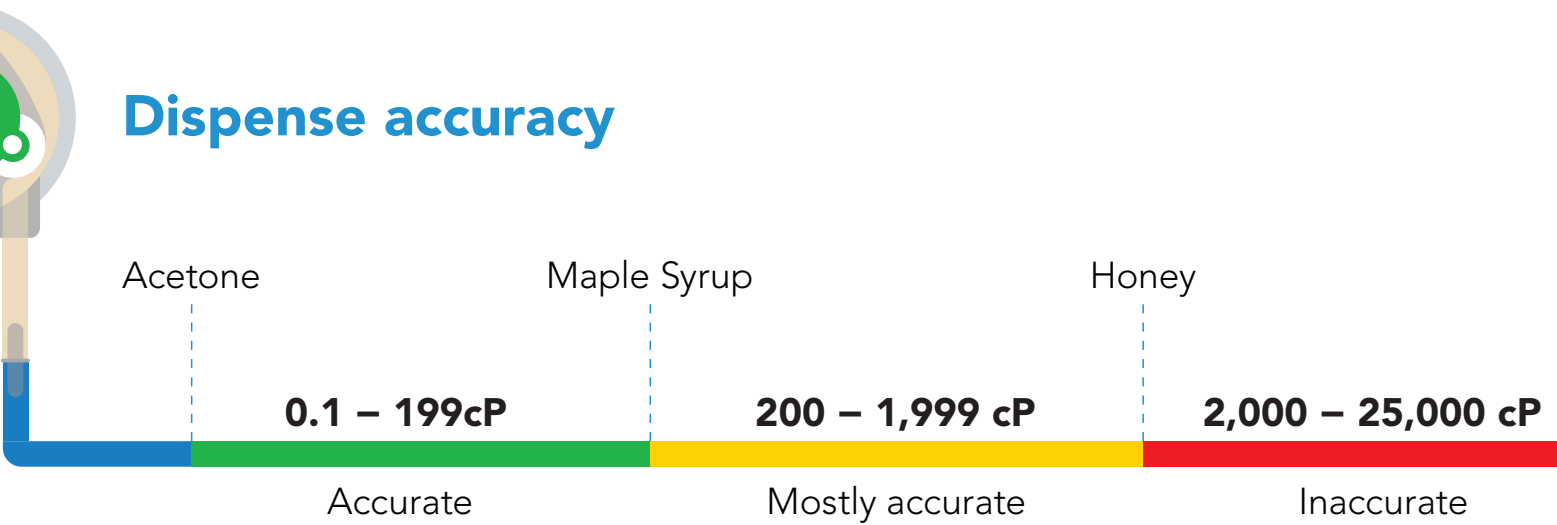

Pump head

Pump head refers to the maximum vertical height a pump can dispense. The EZO-PMP™ has a pump head of 8.1 meters (26.5').

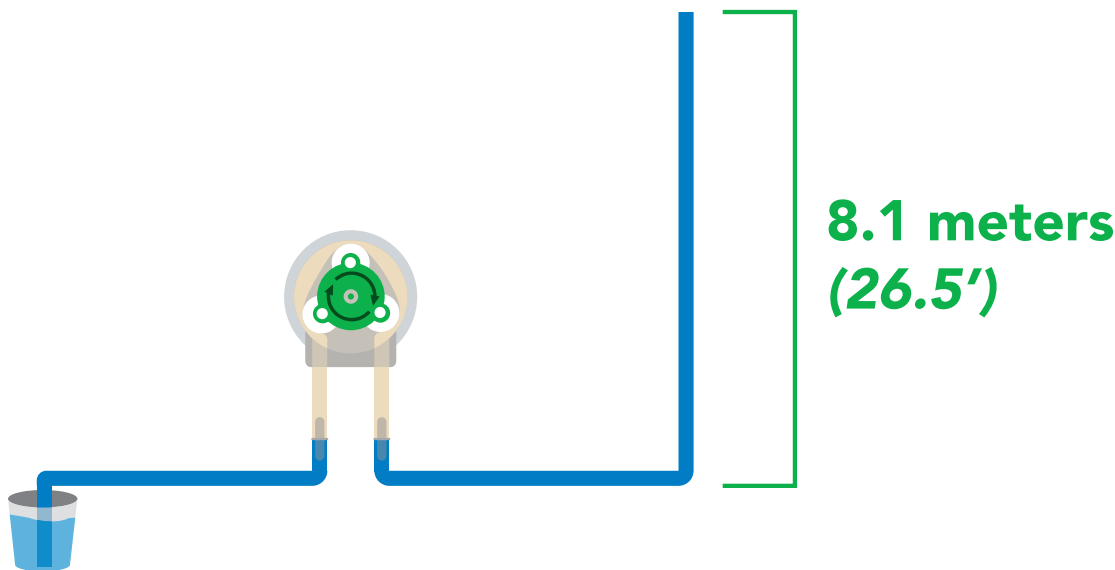

Mounting the EZO-PMP™

There are a many different ways to mount the EZO-PMP™ Embedded Dosing Pump. If you have a 3D printer you can use the dosing pump stand we created, by clicking [here](#). The dosing pump stand has been measured to perfectly fit the EZO-PMP™ and even has screw holes in place for you to help mount the dosing pump to the stand. Feel free to modify this stand design as needed.

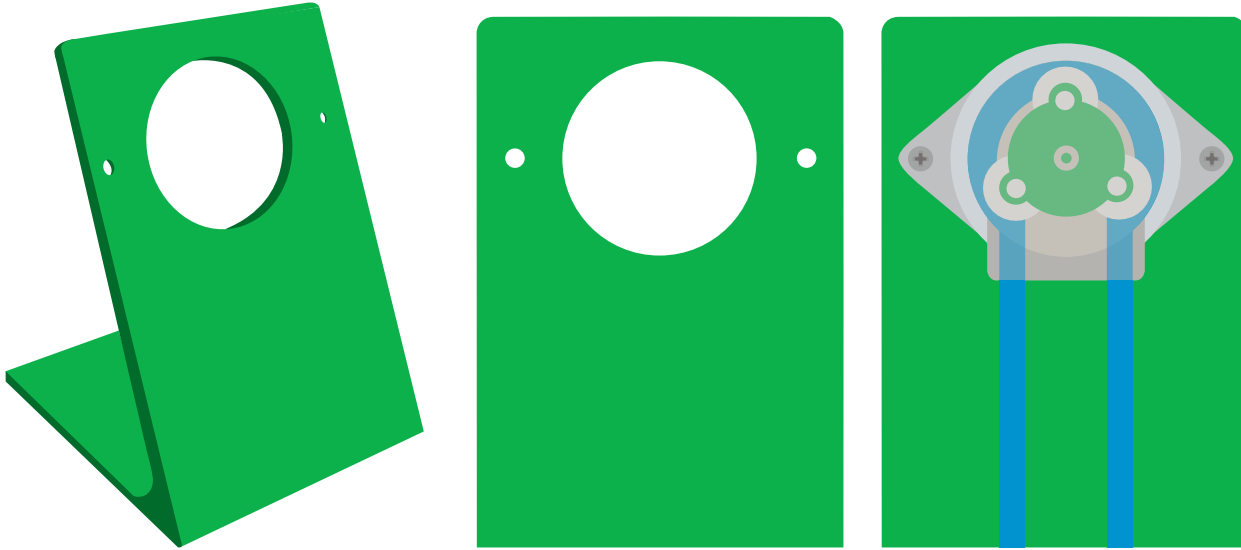

However, if you would like to mount the EZO-PMP™ Embedded Dosing Pump into other materials, you will need the following tools:

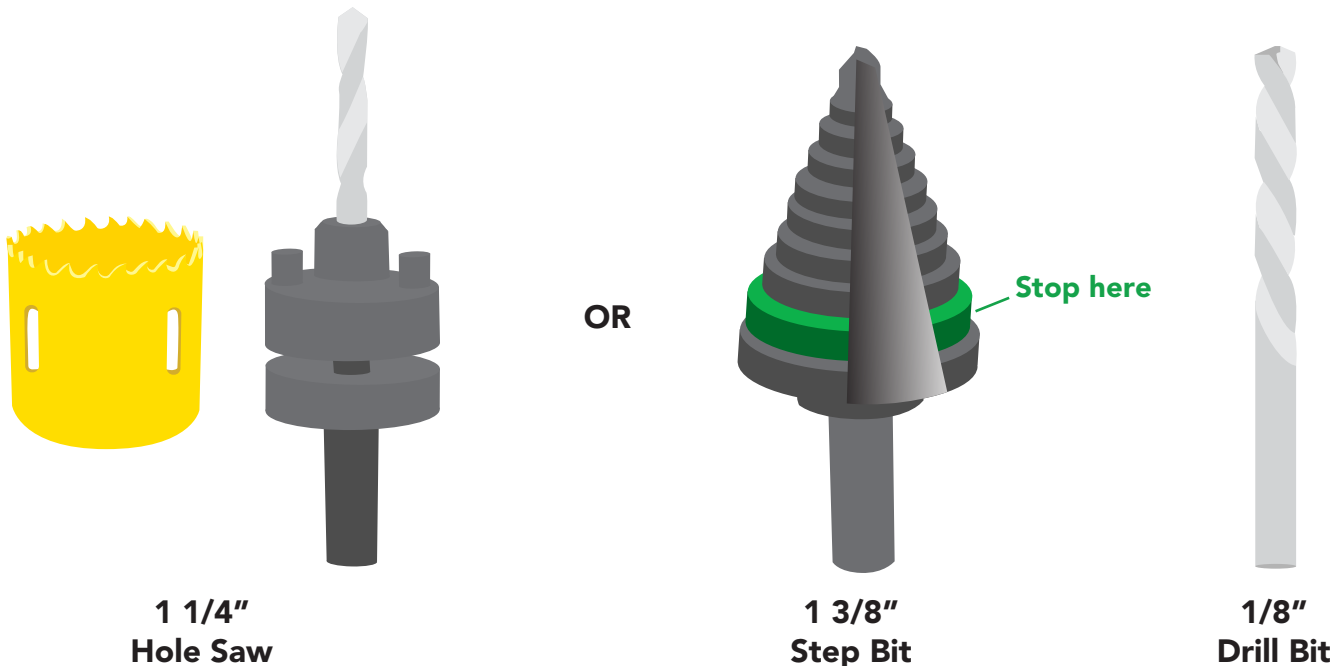

Either are fine to make the larger hole.

Perfect for screw holes.

Datasheet change log

Datasheet V 2.9

Revised table of contents and added invert dispensing direction command on pages 29 & 63.

Datasheet V 2.8

Revised naming device info on pages 38 & 69.

Datasheet V 2.7

Revised pump head information on pg 14.

Datasheet V 2.6

Revised settings that remain when power is cut on pages 17 & 48.

Datasheet V 2.5

Revised Total Volume Dispensed commands on pages 34 & 65.

Datasheet V 2.4

Added new dispensing mode:

"Dispense at startup" see pages 31 (UART) & 62 (I²C).

Datasheet V 2.3

Added motor life span on pg 4.

Datasheet V 2.2

Added page explaining the power supply needs of the EZO-PMP on pg 3.

Datasheet V 2.1

Moved Default state to pg 14.

Datasheet V 2.0

Revised response for the sleep command in UART mode on pg 40.

Datasheet V 1.9

Added section on viscosity on page 13.

Datasheet V 1.8

Added Find command on pages 22 & 53.

Datasheet V 1.7

Added information on pump tubing on pg 4.

Datasheet change log

Datasheet V 1.6

Added life span of tubing and cassette on pg 3.

Datasheet V 1.5

Added max input / output pressure info to pg 3 and pg 4.

Datasheet V 1.4

Revised definition of response codes on pg 47.

Datasheet V 1.3

Revised art and added pump head information on pg 11.

Datasheet V 1.2

Revised Plock pages to show default value.

Datasheet V 1.1

Added mounting information on pg 70.

Firmware updates

V1.0 – Initial release (April 28, 2017)

V1.01 – (May 9, 2017)

- Fixed bug where the circuit wakes up on I2C commands sent to other addresses

V1.02 – (July 28, 2017)

- Fixed undervolt output typo

V1.03 – (June 26, 2020)

- Added command dstart, which lets the pump automatically dispense a dose on startup

V1.04 – (March 2, 2021)

- Added commands for ease of manufacturing

V1.05 (April 5, 2022)

- Expands dstart command with * and dispense over time

Warranty

Atlas Scientific™ Warranties the EZO-PMP™ Embedded Dosing Pump to be free of defect during the debugging phase of device implementation, or 30 days after receiving the EZO-PMP™ Embedded Dosing Pump (whichever comes first).

The debugging phase

The debugging phase as defined by Atlas Scientific™ is the time period when the EZO-PMP™ Embedded Dosing Pump is inserted into a bread board, or shield. If the EZO-PMP™ Embedded Dosing Pump is being debugged in a bread board, the bread board must be devoid of other components. If the EZO-PMP™ Embedded Dosing Pump is being connected to a microcontroller, the microcontroller must be running code that has been designed to drive the EZO-PMP™ Embedded Dosing Pump exclusively and output the EZO-PMP™ Embedded Dosing Pump data as a serial string.

It is important for the embedded systems engineer to keep in mind that the following activities will void the EZO-PMP™ Embedded Dosing Pump warranty:

- **Soldering any part of the EZO-PMP™ Embedded Dosing Pump.**
- **Running any code, that does not exclusively drive the EZO-PMP™ Embedded Dosing Pump and output its data in a serial string.**
- **Embedding the EZO-PMP™ Embedded Dosing Pump into a custom made device.**
- **Removing any potting compound.**

Reasoning behind this warranty

Because Atlas Scientific™ does not sell consumer electronics; once the device has been embedded into a custom made system, Atlas Scientific™ cannot possibly warranty the EZO-PMP™ Embedded Dosing Pump, against the thousands of possible variables that may cause the EZO-PMP™ Embedded Dosing Pump to no longer function properly.

Please keep this in mind:

- 1. All Atlas Scientific™ devices have been designed to be embedded into a custom made system by you, the embedded systems engineer.**
- 2. All Atlas Scientific™ devices have been designed to run indefinitely without failure in the field.**
- 3. All Atlas Scientific™ devices can be soldered into place, however you do so at your own risk.**

Atlas Scientific™ is simply stating that once the device is being used in your application, Atlas Scientific can no longer take responsibility for the EZO-PMP™ Embedded Dosing Pumps continued operation. This is because that would be equivalent to Atlas Scientific™ taking responsibility over the correct operation of your entire device.