

# USB Type C connectors and cables

The USB Type-C connector is designed to accept a plug in any direction. We offer over 125 different styles depending on your application.

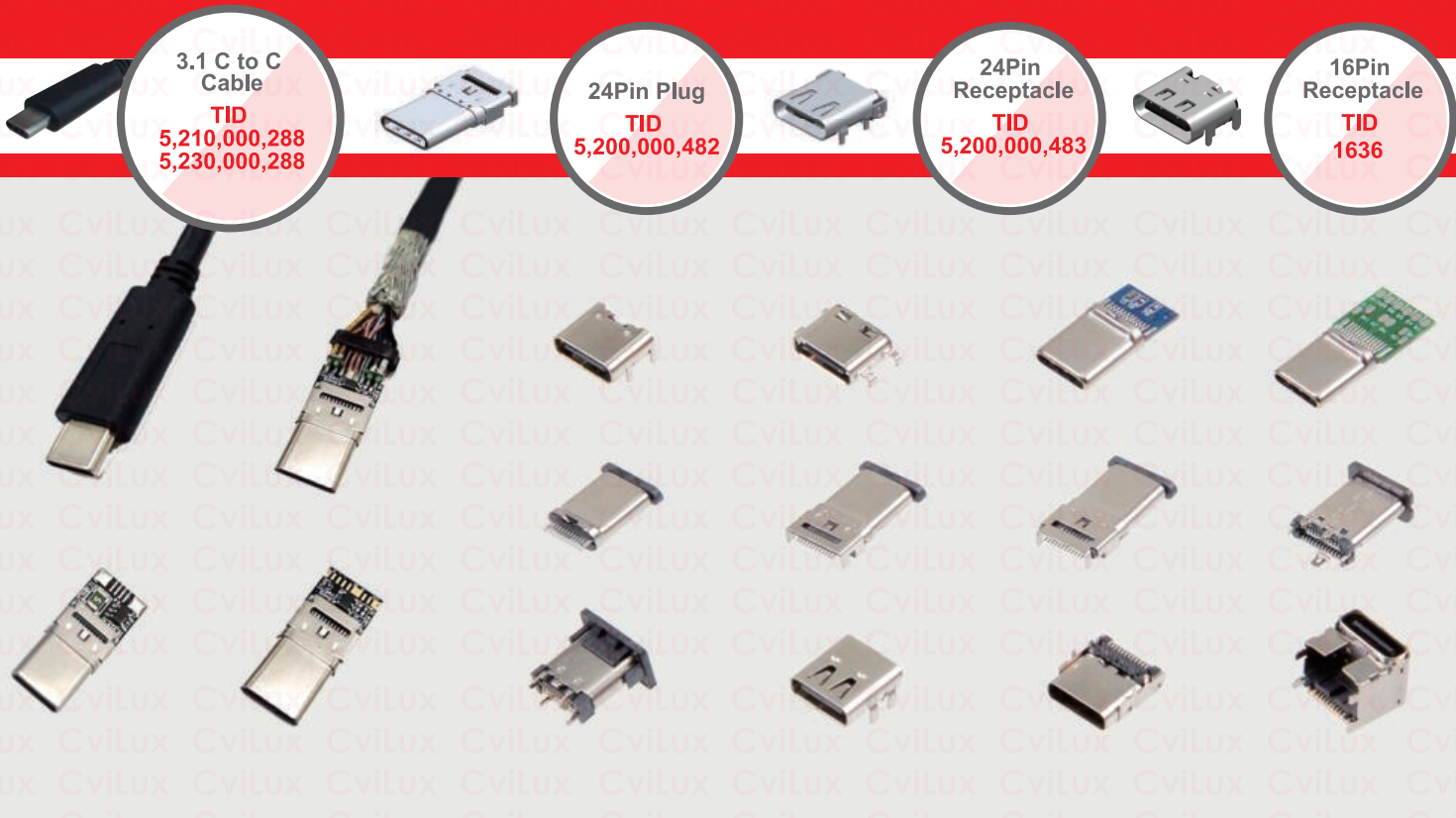

## Specification

- Durability: 10,000 cycles
- Improved EMI and RFI mitigation features
- Provide one interconnect solution for data up to 10Gbps, power up to 100W at 20V
- Power delivery capacity: 3A for standard cables, 5A for connectors

## Features

- Water proof options available
- E-Mark IC (Optional), Support Power Delivery 3.0
- Overcurrent Protection (Optional), Backup Safety
- Supports USB 2.0 / USB 3.1 Gen 1 (5Gbps) / USB 3.1 Gen 2 (10Gbps)
- The Cvilux USB-C to USB-C Cable provides you to charge your USB-C enabled device quickly and safely. Simply plug into any USB-C port to not only charge, but sync and transfer data as well. With a sleek and low profile connector, this cable's minimal design harnesses the incredible power within.

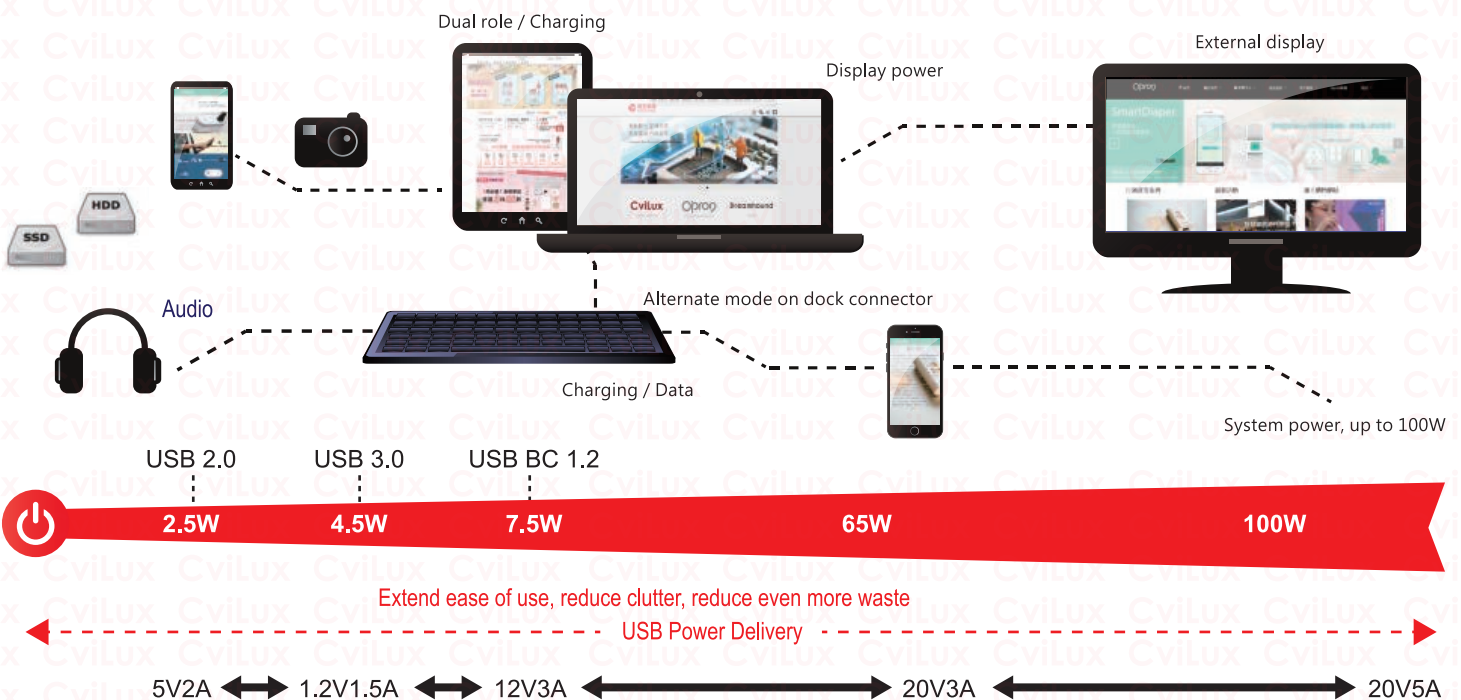

# USB Type C Series

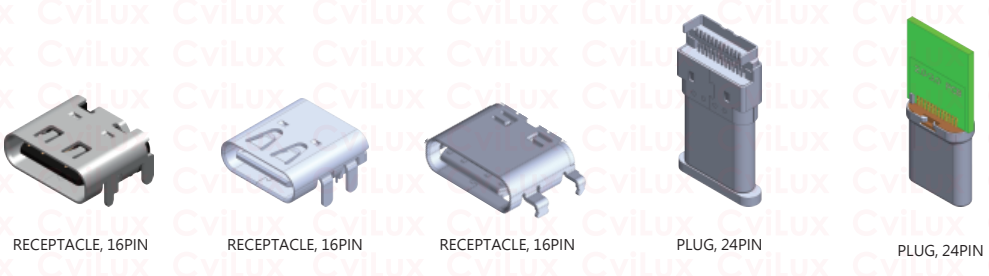
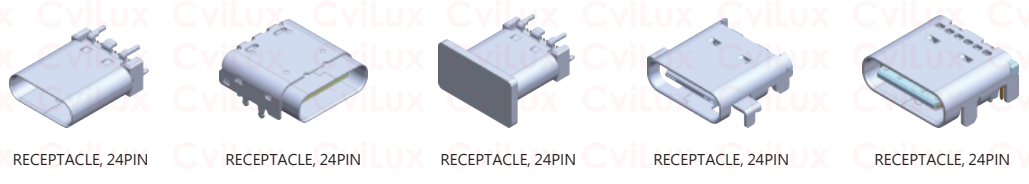

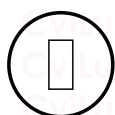
-  Anti-corrosion 抗腐蝕
-  Durable 持久耐用
-  Quality Material 精挑材質
-  EMI 良好遮蔽
-  High Current 高電流
-  Impact Resistance 抗衝擊
-  High Strength Structural 高強度結構
-  Vertical, DIP 直立式DIP
-  Vertical, SMT 直立式SMT
-  PCB Clip, DIP 夾板式DIP
-  IPX7 30min/1m
-  Middle mount, SMT 沉板式SMT
-  Top Mount, SMT 板上型SMT

瀚荃集團  
Cvilux Group  
Since 1990

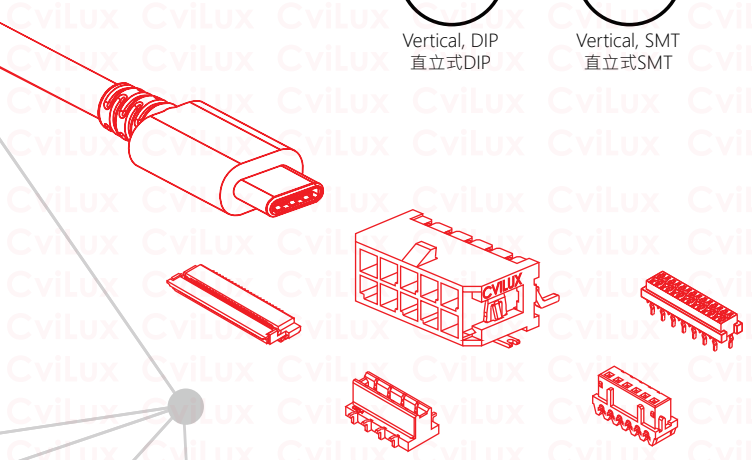

Connect the World, Connect the Future.