

MIRELLA-50-S-PF

~15° spot beam

TECHNICAL SPECIFICATIONS:

Dimensions	Ø 49.9 mm
Height	24 mm
Fastening	socket
ROHS compliant	yes ⓘ

MATERIAL SPECIFICATIONS:

Component	Type	Material	Colour	Finish	Coating
MIRELLA-50-S-PF	Reflector	PC	metal		lacquer

ORDERING INFORMATION:



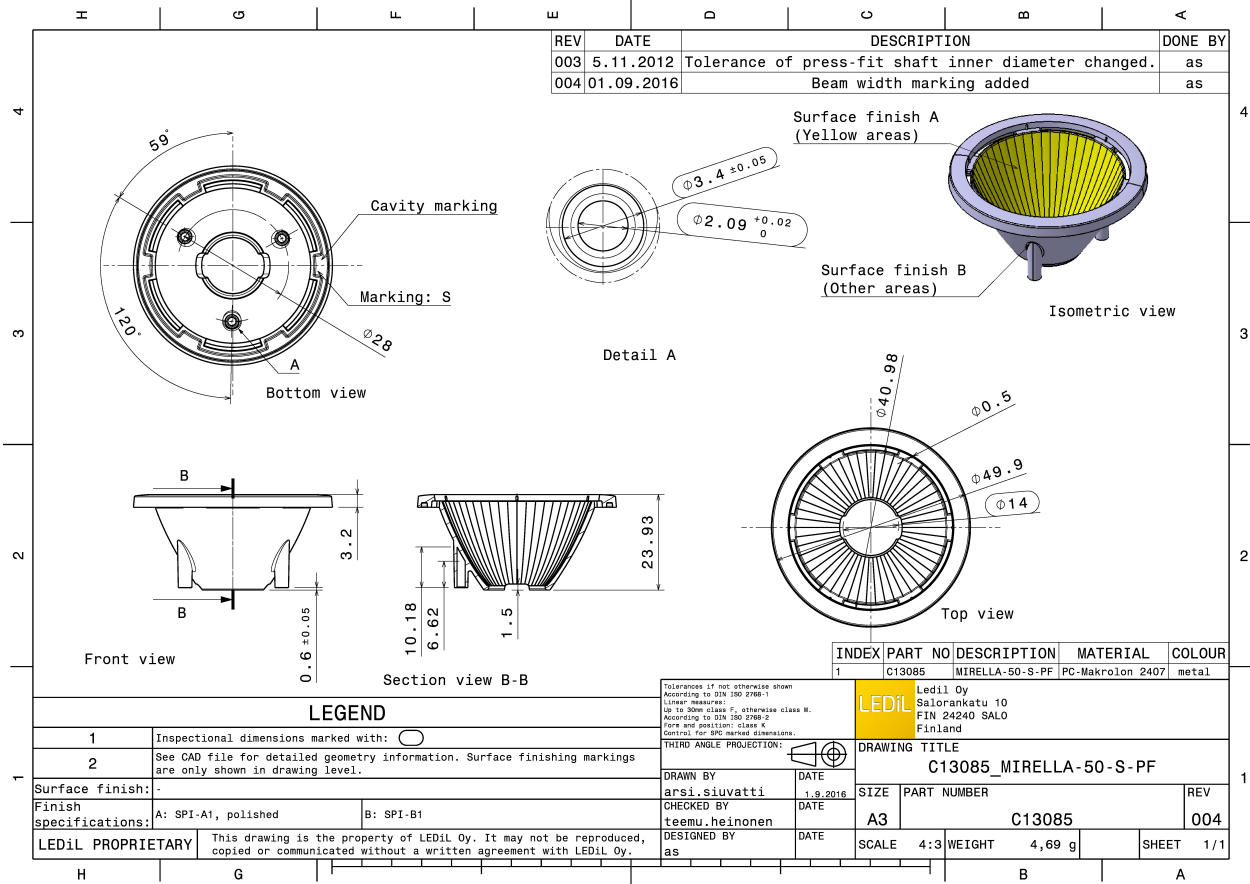

Component	Qty in box	MOQ	MPQ	Box weight (kg)
C13085_MIRELLA-50-S-PF » Box size: 480 x 280 x 300 mm	336	112	28	3.0





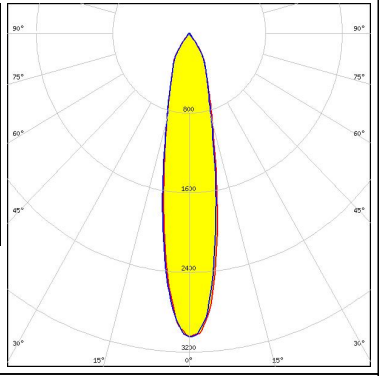

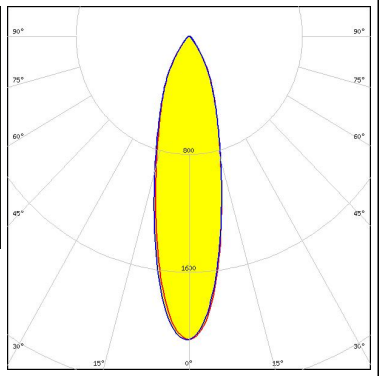

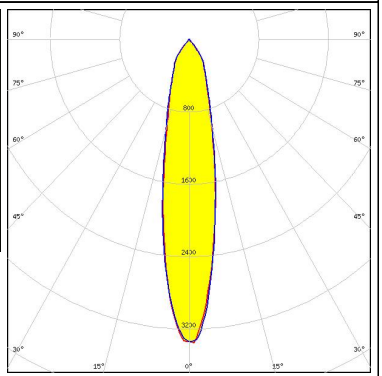
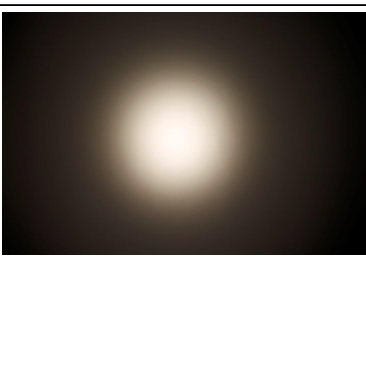
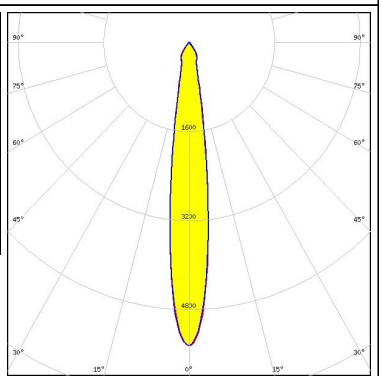



See also our general installation guide: www.ledil.com/installation_guide

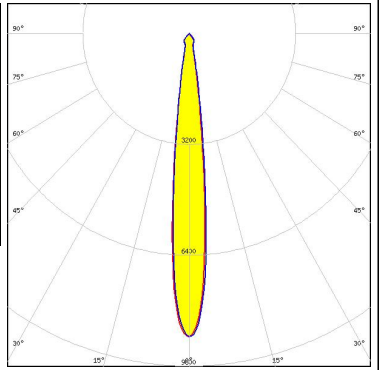

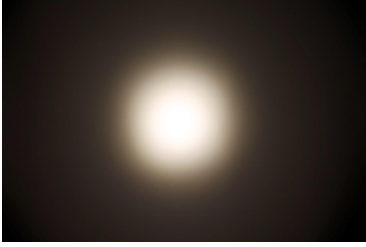
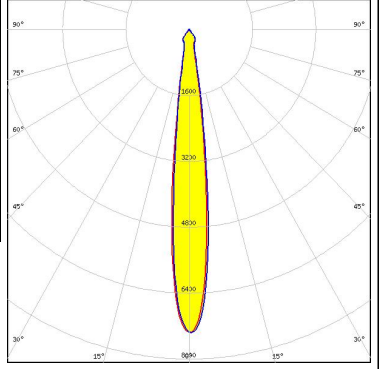

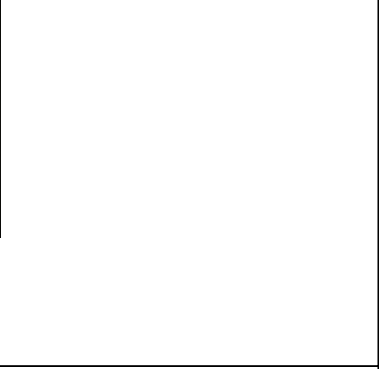
PHOTOMETRIC DATA (MEASURED):

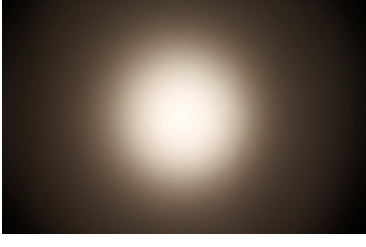
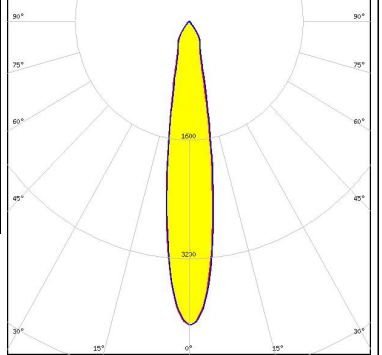
<p>bridgelux.</p> <p>LED V10 Gen7</p> <p>FWHM / FWTM 21.0° / 61.0°</p> <p>Efficiency 81 %</p> <p>Peak intensity 3.1 cd/m</p> <p>LEDs/each optic 1</p> <p>Light colour White</p> <p>Required components:</p> <p>C13709_PF-SOCKET-VERO13-18</p> <p>C13333_MIRELLA-CL</p>		
<p>bridgelux.</p> <p>LED V10 Gen7</p> <p>FWHM / FWTM 26.0° / 66.0°</p> <p>Efficiency 79 %</p> <p>Peak intensity 2.1 cd/m</p> <p>LEDs/each optic 1</p> <p>Light colour White</p> <p>Required components:</p> <p>C13709_PF-SOCKET-VERO13-18</p> <p>C12479_MIRELLA-DL</p>		
<p>bridgelux.</p> <p>LED V10 Gen7</p> <p>FWHM / FWTM 21.0° / 61.0°</p> <p>Efficiency 91 %</p> <p>Peak intensity 3.4 cd/m</p> <p>LEDs/each optic 1</p> <p>Light colour White</p> <p>Required components:</p> <p>C13709_PF-SOCKET-VERO13-18</p> <p>Bender Wirth: 486 Typ L1</p>		
<p>bridgelux.</p> <p>LED V6 Gen6</p> <p>FWHM / FWTM 15.0° / 33.0°</p> <p>Efficiency 84 %</p> <p>Peak intensity 5.5 cd/m</p> <p>LEDs/each optic 1</p> <p>Light colour White</p> <p>Required components:</p> <p>C13761_PF-SOCKET-CXA15</p> <p>C12479_MIRELLA-DL</p>		



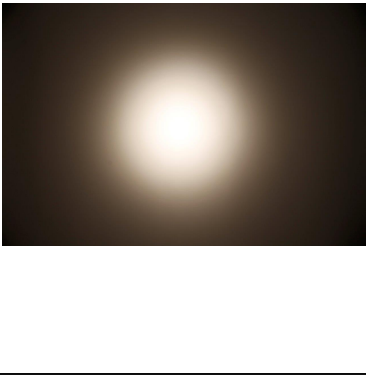
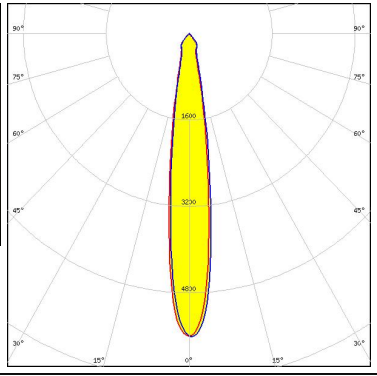

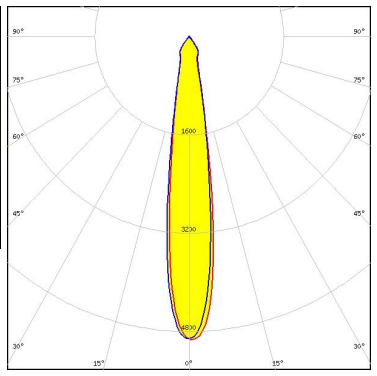



PHOTOMETRIC DATA (MEASURED):

<p></p> <p>LED V6 Gen6 FWHM / FWTM 12.0° / 25.0° Efficiency 90 % Peak intensity 8.8 cd/m LEDs/each optic 1 Light colour White Required components: C13761_PF-SOCKET-CXA15</p>		
<p></p> <p>LED V6 Gen6 FWHM / FWTM 13.0° / 26.0° Efficiency 84 % Peak intensity 7.4 cd/m LEDs/each optic 1 Light colour White Required components: C13761_PF-SOCKET-CXA15 C13333_MIRELLA-CL</p>		
<p></p> <p>LED V6 Gen6 FWHM / FWTM 18.0° / 52.0° Efficiency 73 % Peak intensity 4.3 cd/m LEDs/each optic 1 Light colour White Required components: C13709_PF-SOCKET-VERO13-18 C12479_MIRELLA-DL Bender Wirth: 460 Typ L1</p>		
<p></p> <p>LED V8 Gen6 FWHM / FWTM 18.0° / 44.0° Efficiency 85 % Peak intensity 4.1 cd/m LEDs/each optic 1 Light colour White Required components: C13761_PF-SOCKET-CXA15 C12479_MIRELLA-DL</p>		

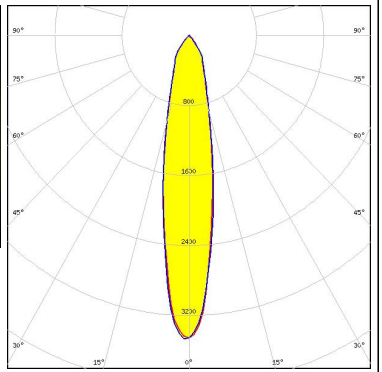

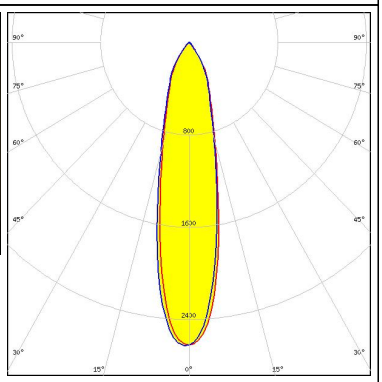

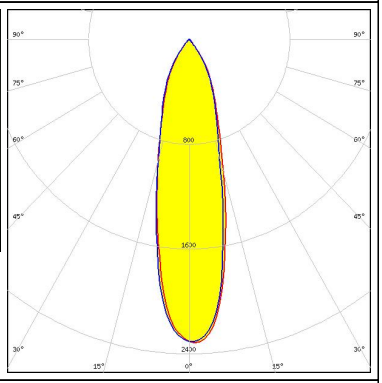

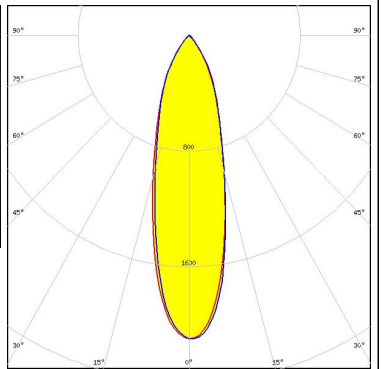

PHOTOMETRIC DATA (MEASURED):

<p>bridgelux.</p> <p>LED V8 Gen6 FWHM / FWTM 15.0° / 34.0° Efficiency 90 % Peak intensity 5.6 cd/m LEDs/each optic 1 Light colour White Required components: C13761_PF-SOCKET-CXA15</p>		
<p>bridgelux.</p> <p>LED V8 Gen6 FWHM / FWTM 16.0° / 36.0° Efficiency 84 % Peak intensity 4.9 cd/m LEDs/each optic 1 Light colour White Required components: C13761_PF-SOCKET-CXA15 C13333_MIRELLA-CL</p>		
<p>bridgelux.</p> <p>LED V8 Gen6 FWHM / FWTM 20.0° / 62.0° Efficiency 71 % Peak intensity 3.4 cd/m LEDs/each optic 1 Light colour White Required components: C13709_PF-SOCKET-VERO13-18 C12479_MIRELLA-DL Bender Wirth: 460 Typ L1</p>		
<p>bridgelux.</p> <p>LED VERO10 FWHM / FWTM 23.0° / 63.0° Efficiency 83 % Peak intensity 2.6 cd/m LEDs/each optic 1 Light colour White Required components: C13708_PF-SOCKET-VERO10 C13333_MIRELLA-CL</p>		

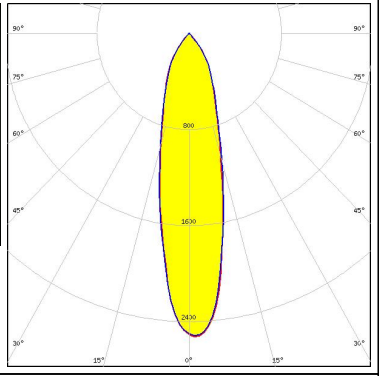
PHOTOMETRIC DATA (MEASURED):

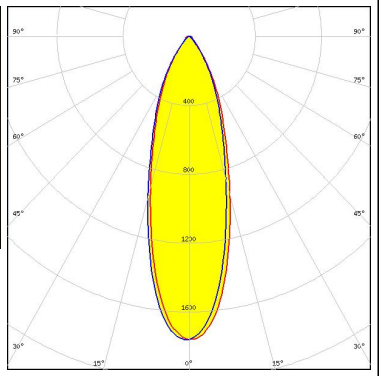
<p></p> <p>LED VERO10 FWHM / FWTM 20.0° / 57.0° Efficiency 88 % Peak intensity 3.5 cd/m LEDs/each optic 1 Light colour White Required components: C13708_PF-SOCKET-VERO10</p>		
<p></p> <p>LED VERO10 FWHM / FWTM 23.0° / 63.0° Efficiency 83 % Peak intensity 2.6 cd/m LEDs/each optic 1 Light colour White Required components: C13708_PF-SOCKET-VERO10 C12479_MIRELLA-DL</p>		
<p></p> <p>LED VERO13 FWHM / FWTM 26.0° / 67.0° Efficiency 83 % Peak intensity 2.3 cd/m LEDs/each optic 1 Light colour White Required components: C13709_PF-SOCKET-VERO13-18 C13333_MIRELLA-CL</p>		
<p></p> <p>LED VERO13 FWHM / FWTM 28.0° / 68.0° Efficiency 84 % Peak intensity 2.1 cd/m LEDs/each optic 1 Light colour White Required components: C13709_PF-SOCKET-VERO13-18 C12479_MIRELLA-DL</p>		

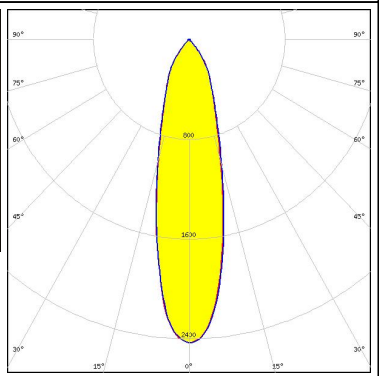
PHOTOMETRIC DATA (MEASURED):

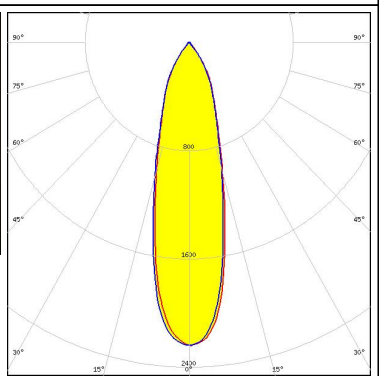
<p></p> <p>LED VERO13 FWHM / FWTM 25.0° / 69.0° Efficiency 89 % Peak intensity 2.5 cd/m LEDs/each optic 1 Light colour White Required components: C13709_PF-SOCKET-VERO13-18</p>		
<p></p> <p>LED Xenio Point 13mm FWHM / FWTM 31.0° / 70.0° Efficiency 81 % Peak intensity 1.8 cd/m LEDs/each optic 1 Light colour White Required components: C13709_PF-SOCKET-VERO13-18 C12479_MIRELLA-DL</p>		
<p></p> <p>LED Xenio Point 13mm FWHM / FWTM 26.0° / 69.0° Efficiency 87 % Peak intensity 2.4 cd/m LEDs/each optic 1 Light colour White Required components: C13709_PF-SOCKET-VERO13-18</p>		
<p></p> <p>LED Xenio Point 13mm FWHM / FWTM 27.0° / 67.0° Efficiency 83 % Peak intensity 2.2 cd/m LEDs/each optic 1 Light colour White Required components: C13709_PF-SOCKET-VERO13-18 C13333_MIRELLA-CL</p>		

PHOTOMETRIC DATA (MEASURED):

CITIZEN

LED CLL01x
FWHM / FWTM 15.0° / 32.0°
Efficiency 84 %
Peak intensity 5.8 cd/lm
LEDs/each optic 1
Light colour White
Required components:
C13083_PF-SOCKET
C12479_MIRELLA-DL



CITIZEN

LED CLL01x
FWHM / FWTM 13.0° / 27.0°
Efficiency 84 %
Peak intensity 7.6 cd/lm
LEDs/each optic 1
Light colour White
Required components:
C13083_PF-SOCKET
C13333_MIRELLA-CL



CITIZEN

LED CLL01x
FWHM / FWTM 14.0° / 27.0°
Efficiency 88 %
Peak intensity 7.7 cd/lm
LEDs/each optic 1
Light colour White
Required components:
C13083_PF-SOCKET

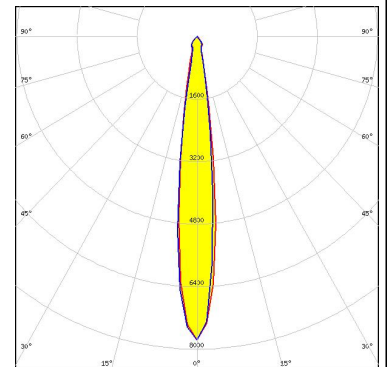

CITIZEN

LED CLL02x/CLU02x (LES10)
FWHM / FWTM 20.0° / 54.0°
Efficiency 83 %
Peak intensity 4.2 cd/lm
LEDs/each optic 1
Light colour White
Required components:
C13083_PF-SOCKET
C12479_MIRELLA-DL



PHOTOMETRIC DATA (MEASURED):

CITIZEN

LED CLL02x/CLU02x (LES10)
 FWHM / FWTM 18.0° / 43.0°
 Efficiency 83 %
 Peak intensity 5.1 cd/lm
 LEDs/each optic 1
 Light colour White
 Required components:
 C13083_PF-SOCKET
 C13333_MIRELLA-CL



CITIZEN

LED CLL02x/CLU02x (LES10)
 FWHM / FWTM 27.0° / 67.0°
 Efficiency 77 %
 Peak intensity 2 cd/lm
 LEDs/each optic 1
 Light colour White
 Required components:
 C13709_PF-SOCKET-VERO13-18
 C12479_MIRELLA-DL
 Bender Wirth: 434 Typ L1

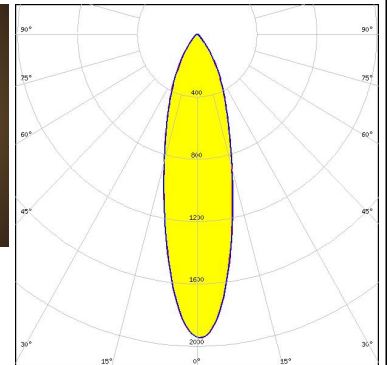
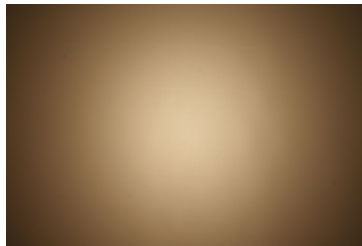

CITIZEN

LED CLL02x/CLU02x (LES10)
 FWHM / FWTM 21.0° / 63.0°
 Efficiency 84 %
 Peak intensity 3.1 cd/lm
 LEDs/each optic 1
 Light colour White
 Required components:
 C13709_PF-SOCKET-VERO13-18
 Bender Wirth: 434 Typ L1

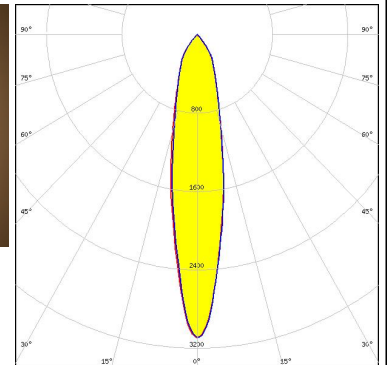
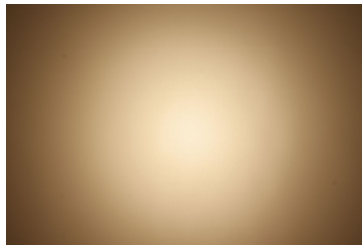

CITIZEN

LED CLL02x/CLU02x (LES10)
 FWHM / FWTM 25.0° / 64.0°
 Efficiency %
 Peak intensity 1.5 cd/lm
 LEDs/each optic 1
 Light colour White
 Required components:
 C13083_PF-SOCKET
 C13723_MIRELLA-RZL

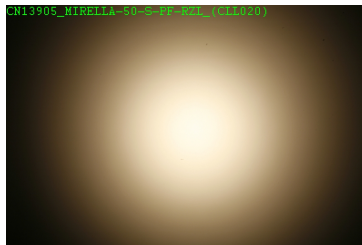

PHOTOMETRIC DATA (MEASURED):

CITIZEN

LED CLL02x/CLU02x (LES10)
 FWHM / FWTM 20.0° / 61.0°
 Efficiency 80 %
 Peak intensity 3.1 cd/lm
 LEDs/each optic 1
 Light colour White
 Required components:
 C13709_PF-SOCKET-VERO13-18
 C13333_MIRELLA-CL
 Bender Wirth: 434 Typ L1

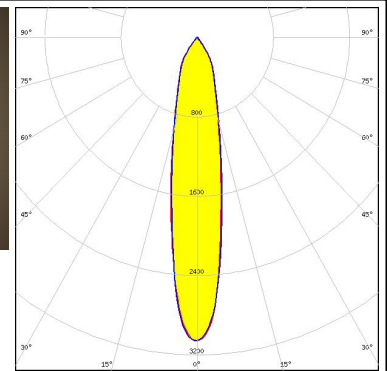

CITIZEN

LED CLL02x/CLU02x (LES10)
 FWHM / FWTM 19.0° / 46.0°
 Efficiency 87 %
 Peak intensity 4.2 cd/lm
 LEDs/each optic 1
 Light colour White
 Required components:
 C13083_PF-SOCKET

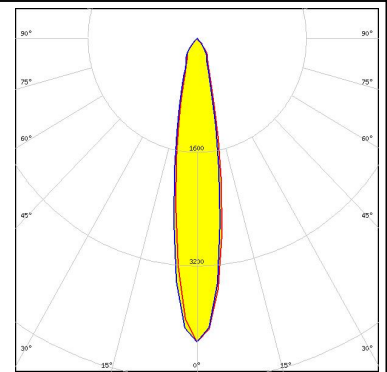

CITIZEN

LED CLU700/701/702
 FWHM / FWTM 13.0° / 29.0°
 Efficiency 89 %
 Peak intensity 7.3 cd/lm
 LEDs/each optic 1
 Light colour White
 Required components:
 C13083_PF-SOCKET

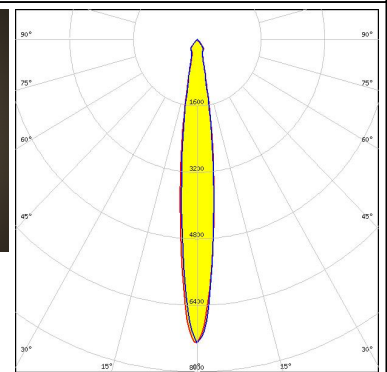
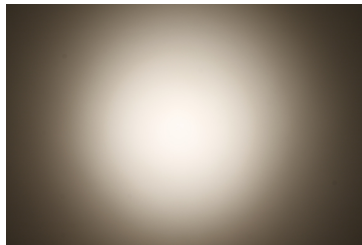

CITIZEN

LED CLU700/701/702
 FWHM / FWTM 23.0° / 61.0°
 Efficiency 82 %
 Peak intensity 2.5 cd/lm
 LEDs/each optic 1
 Light colour White
 Required components:
 C13083_PF-SOCKET
 C13723_MIRELLA-RZL

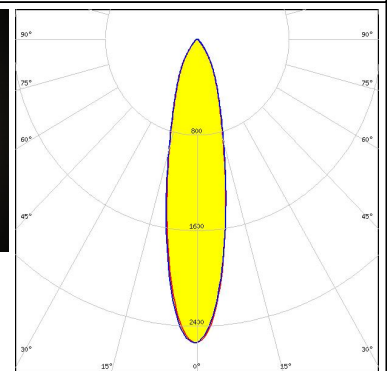
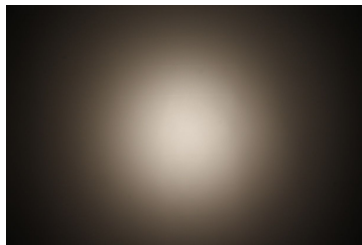

PHOTOMETRIC DATA (MEASURED):

CITIZEN

LED CLU700/701/702
 FWHM / FWTM 20.0° / 58.0°
 Efficiency 79 %
 Peak intensity 3.1 cd/lm
 LEDs/each optic 1
 Light colour White
 Required components:
 C13709_PF-SOCKET-VERO13-18
 C12479_MIRELLA-DL
 Bender Wirth: 434 Typ L1

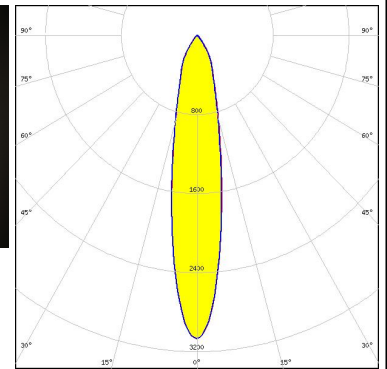
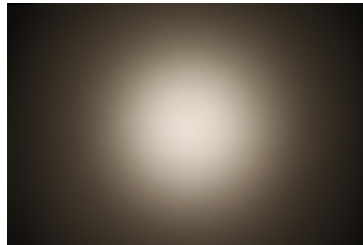

CITIZEN

LED CLU700/701/702
 FWHM / FWTM 17.0° / 47.0°
 Efficiency 82 %
 Peak intensity 4 cd/lm
 LEDs/each optic 1
 Light colour White
 Required components:
 C13083_PF-SOCKET
 C12479_MIRELLA-DL

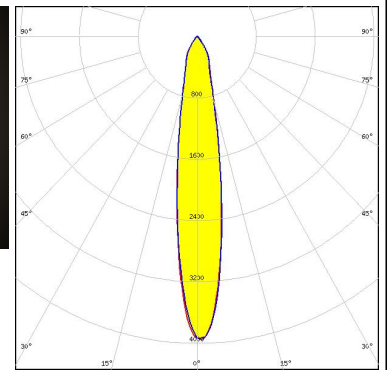

CITIZEN

LED CLU700/701/702
 FWHM / FWTM 19.0° / 47.0°
 Efficiency 84 %
 Peak intensity 4 cd/lm
 LEDs/each optic 1
 Light colour White
 Required components:
 C13709_PF-SOCKET-VERO13-18
 Bender Wirth: 434 Typ L1

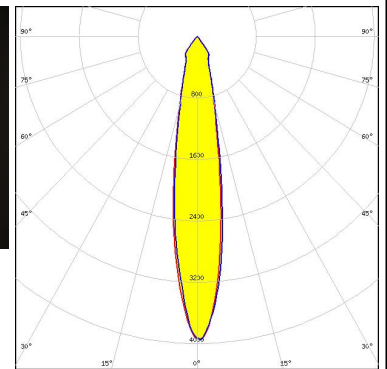
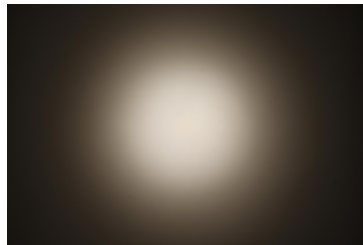

CITIZEN

LED CLU700/701/702
 FWHM / FWTM 13.0° / 30.0°
 Efficiency 83 %
 Peak intensity 6.6 cd/lm
 LEDs/each optic 1
 Light colour White
 Required components:
 C13083_PF-SOCKET
 C13333_MIRELLA-CL

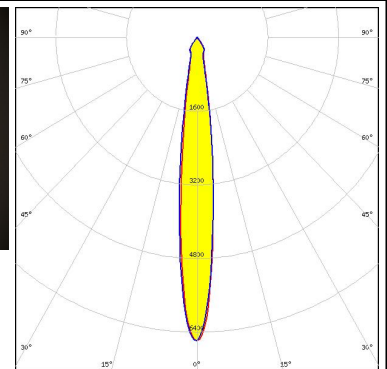

PHOTOMETRIC DATA (MEASURED):

CITIZEN

LED CLU700/701/702
 FWHM / FWTM 14.0° / 40.0°
 Efficiency 79 %
 Peak intensity 4.8 cd/m
 LEDs/each optic 1
 Light colour White
 Required components:
 C13709_PF-SOCKET-VERO13-18
 C13333_MIRELLA-CL
 Bender Wirth: 434 Typ L1

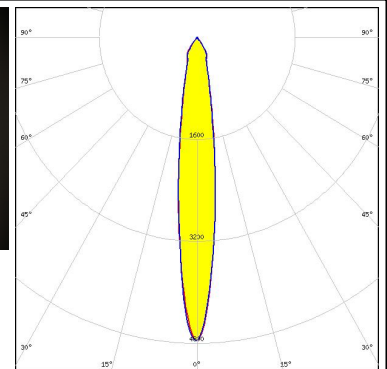

CITIZEN

LED CLU720/721
 FWHM / FWTM 29.0° / 69.0°
 Efficiency 75 %
 Peak intensity 1.7 cd/m
 LEDs/each optic 1
 Light colour White
 Required components:
 C13709_PF-SOCKET-VERO13-18
 C12479_MIRELLA-DL
 Bender Wirth: 433 Typ L1

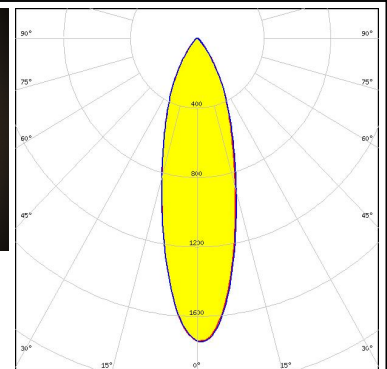
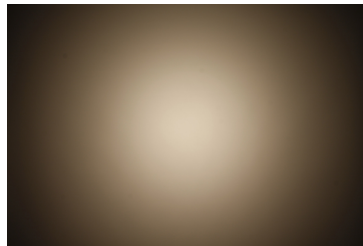

CITIZEN

LED CLU720/721
 FWHM / FWTM 23.0° / 67.0°
 Efficiency 82 %
 Peak intensity 2.6 cd/m
 LEDs/each optic 1
 Light colour White
 Required components:
 C13709_PF-SOCKET-VERO13-18
 Bender Wirth: 433 Typ L1

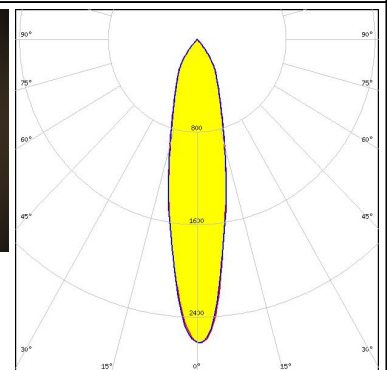
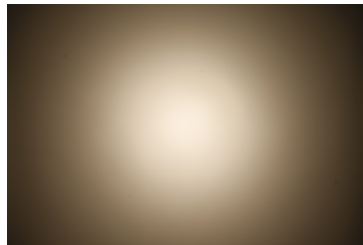

CITIZEN

LED CLU720/721
 FWHM / FWTM 23.0° / 64.0°
 Efficiency 77 %
 Peak intensity 2.5 cd/m
 LEDs/each optic 1
 Light colour White
 Required components:
 C13709_PF-SOCKET-VERO13-18
 C13333_MIRELLA-CL
 Bender Wirth: 433 Typ L1

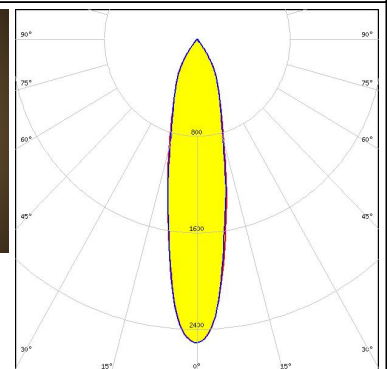
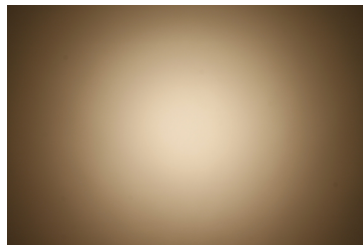

PHOTOMETRIC DATA (MEASURED):



LED CXA/B 13xx
 FWHM / FWTM 15.0° / 36.0°
 Efficiency 81 %
 Peak intensity 5.4 cd/lm
 LEDs/each optic 1
 Light colour White
 Required components:
 C13761_PF-SOCKET-CXA15
 C12479_MIRELLA-DL

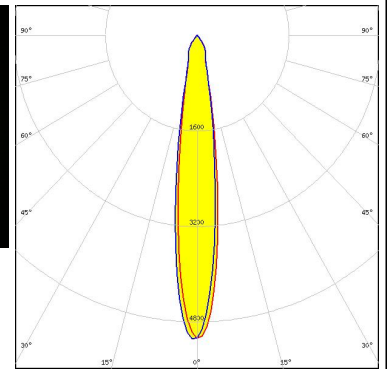

LED CXA/B 13xx
 FWHM / FWTM 12.0° / 25.0°
 Efficiency 87 %
 Peak intensity 9.5 cd/lm
 LEDs/each optic 1
 Light colour White
 Required components:
 C13761_PF-SOCKET-CXA15

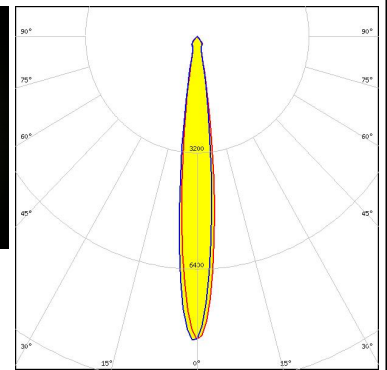
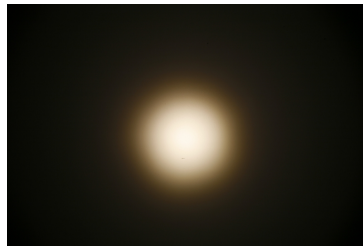

LED CXA/B 13xx
 FWHM / FWTM 12.0° / 25.0°
 Efficiency 82 %
 Peak intensity 8.5 cd/lm
 LEDs/each optic 1
 Light colour White
 Required components:
 C13761_PF-SOCKET-CXA15
 C13333_MIRELLA-CL



LED CXA/B 15xx
 FWHM / FWTM 21.0° / 56.0°
 Efficiency 87 %
 Peak intensity 3.4 cd/lm
 LEDs/each optic 1
 Light colour White
 Required components:
 C13761_PF-SOCKET-CXA15
 C12479_MIRELLA-DL

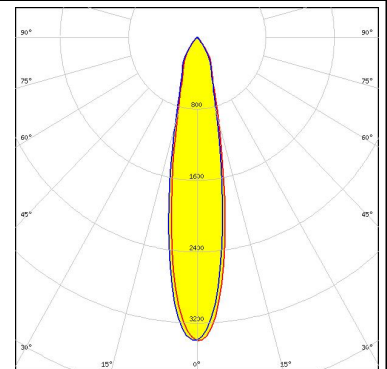

PHOTOMETRIC DATA (MEASURED):



LED CXA/B 15xx
 FWHM / FWTM 26.0° / 66.0°
 Efficiency 77 %
 Peak intensity 2.1 cd/m
 LEDs/each optic 1
 Light colour White

Required components:

C13709_PF-SOCKET-VERO13-18
 C12479_MIRELLA-DL
 Bender Wirth: 441 Typ L1

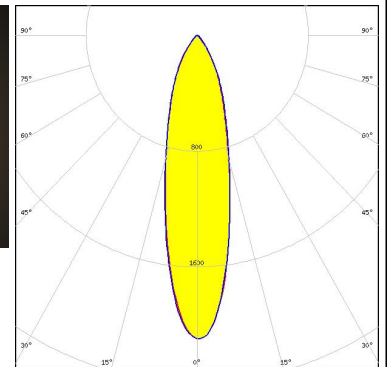
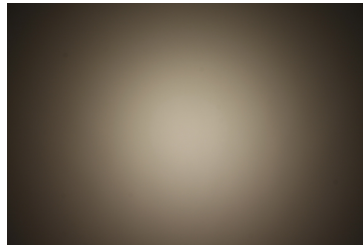

LED CXA/B 15xx
 FWHM / FWTM 18.0° / 43.0°
 Efficiency 91 %
 Peak intensity 4.4 cd/m
 LEDs/each optic 1
 Light colour White

Required components:

C13761_PF-SOCKET-CXA15

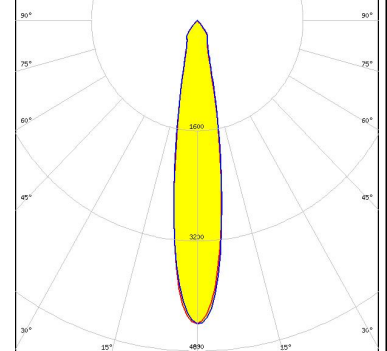

LED CXA/B 15xx
 FWHM / FWTM 20.0° / 60.0°
 Efficiency 84 %
 Peak intensity 3.3 cd/m
 LEDs/each optic 1
 Light colour White

Required components:

C13709_PF-SOCKET-VERO13-18
 Bender Wirth: 441 Typ L1

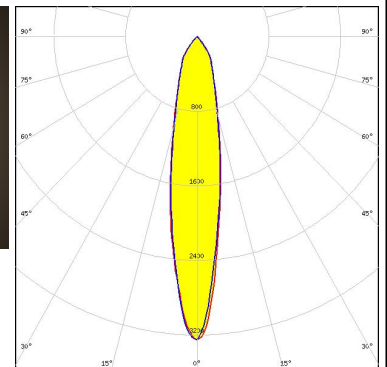
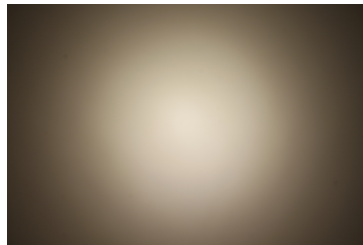

LED CXA/B 15xx
 FWHM / FWTM 27.0° / 65.0°
 Efficiency 82 %
 Peak intensity 2.3 cd/m
 LEDs/each optic 1
 Light colour White

Required components:

C13761_PF-SOCKET-CXA15
 C13723_MIRELLA-RZL

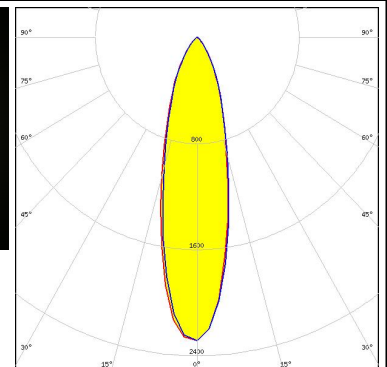
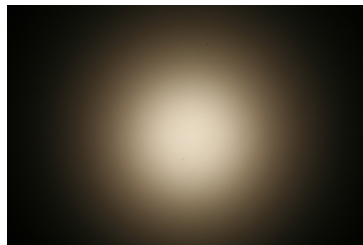

PHOTOMETRIC DATA (MEASURED):



LED CXA/B 15xx
 FWHM / FWTM 19.0° / 59.0°
 Efficiency 79 %
 Peak intensity 3.3 cd/lm
 LEDs/each optic 1
 Light colour White

Required components:

C13709_PF-SOCKET-VERO13-18
 C13333_MIRELLA-CL
 Bender Wirth: 441 Typ L1

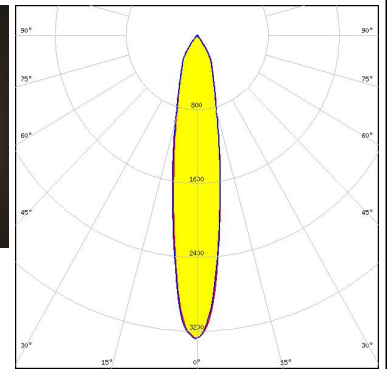
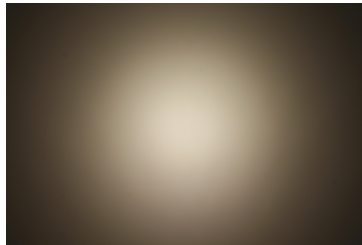

LED CXA/B 15xx
 FWHM / FWTM 19.0° / 47.0°
 Efficiency 84 %
 Peak intensity 4.3 cd/lm
 LEDs/each optic 1
 Light colour White

Required components:

C13761_PF-SOCKET-CXA15
 C13333_MIRELLA-CL



LED CXA/B 1816 & CXA/B 1820 & CXA 1850
 FWHM / FWTM 23.0° / 67.0°
 Efficiency 89 %
 Peak intensity 2.8 cd/lm
 LEDs/each optic 1
 Light colour White

Required components:

IDEAL: 50-2101CR + 50-2100MR

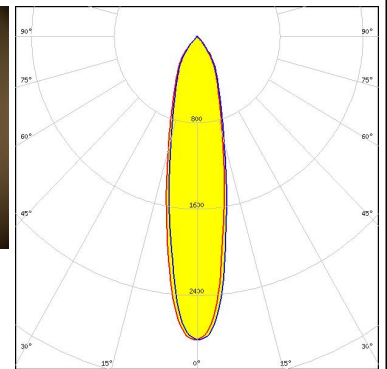
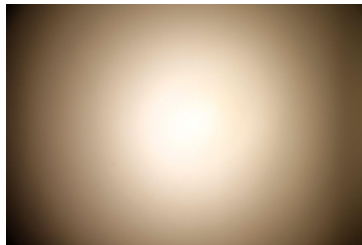

LED CXA/B 1816 & CXA/B 1820 & CXA 1850
 FWHM / FWTM 25.0° / 68.0°
 Efficiency 85 %
 Peak intensity 2.7 cd/lm
 LEDs/each optic 1
 Light colour White

Required components:

C14115_PF-SOCKET-CXA15-18

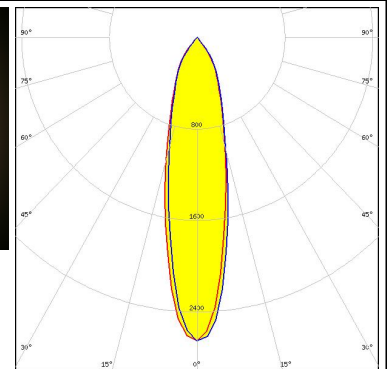
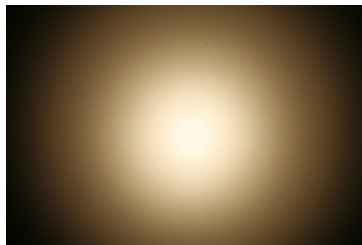

PHOTOMETRIC DATA (MEASURED):



LED MHD-E/G
 FWHM / FWTM 14.0° / 31.0°
 Efficiency 93 %
 Peak intensity 6.1 cd/lm
 LEDs/each optic 1
 Light colour White
 Required components:
 C13083_PF-SOCKET

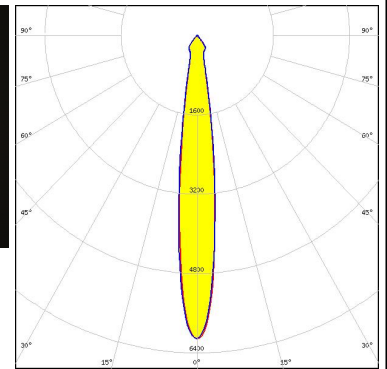
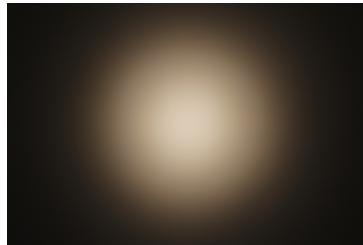

LED MHD-E/G
 FWHM / FWTM 24.0° / 65.0°
 Efficiency 84 %
 Peak intensity 2.3 cd/lm
 LEDs/each optic 1
 Light colour White
 Required components:
 C13083_PF-SOCKET
 C13723_MIRELLA-RZL

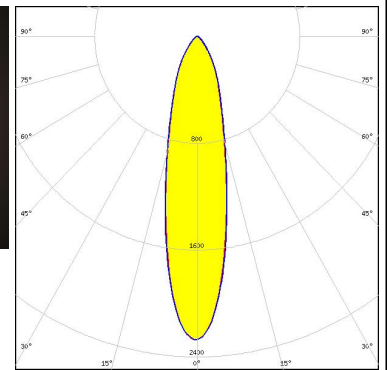
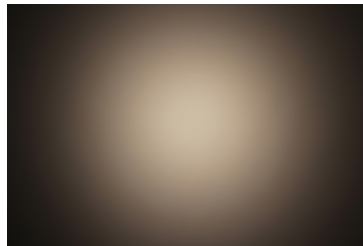

LED MHD-E/G
 FWHM / FWTM 17.0° / 44.0°
 Efficiency 87 %
 Peak intensity 4.1 cd/lm
 LEDs/each optic 1
 Light colour White
 Required components:
 C13083_PF-SOCKET
 C12479_MIRELLA-DL

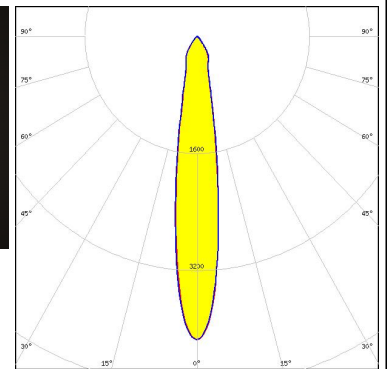
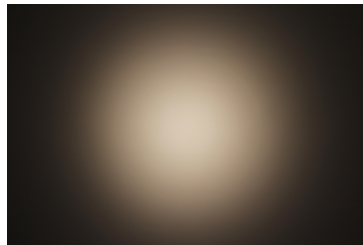

LED MHD-E/G
 FWHM / FWTM 15.0° / 32.0°
 Efficiency 87 %
 Peak intensity 5.4 cd/lm
 LEDs/each optic 1
 Light colour White
 Required components:
 C13083_PF-SOCKET
 C13333_MIRELLA-CL

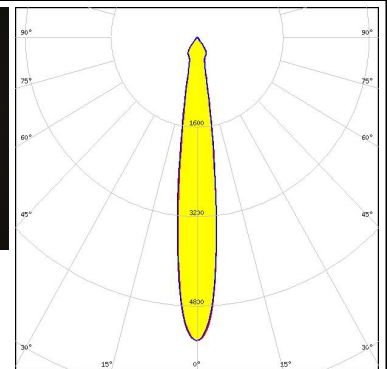

PHOTOMETRIC DATA (MEASURED):

CREE 

LED MK-R
 FWHM / FWTM 12.0° / 27.0°
 Efficiency 87 %
 Peak intensity 8.1 cd/lm
 LEDs/each optic 1
 Light colour White
 Required components:
 C13083_PF-SOCKET

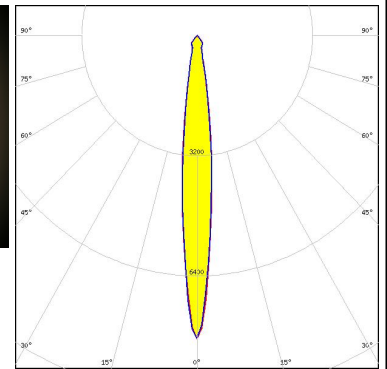

CREE 

LED MK-R
 FWHM / FWTM 15.0° / 37.0°
 Efficiency 82 %
 Peak intensity 4.9 cd/lm
 LEDs/each optic 1
 Light colour White
 Required components:
 C13083_PF-SOCKET
 C12479_MIRELLA-DL

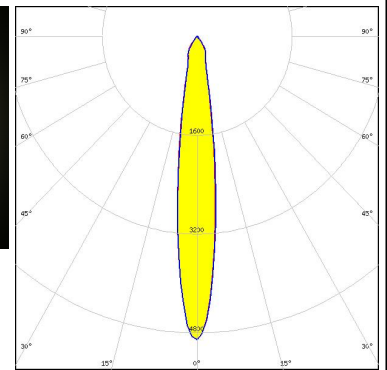
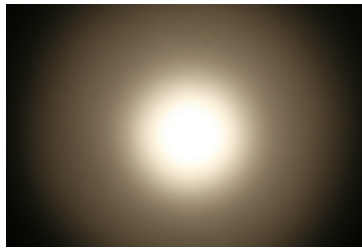

CREE 

LED MT-G
 FWHM / FWTM 18.0° / 34.0°
 Efficiency 86 %
 Peak intensity 5.5 cd/lm
 LEDs/each optic 1
 Light colour White
 Required components:
 C13083_PF-SOCKET
 C13333_MIRELLA-CL



CREE 

LED MT-G
 FWHM / FWTM 17.0° / 34.0°
 Efficiency 90 %
 Peak intensity 5.3 cd/lm
 LEDs/each optic 1
 Light colour White
 Required components:
 C13083_PF-SOCKET

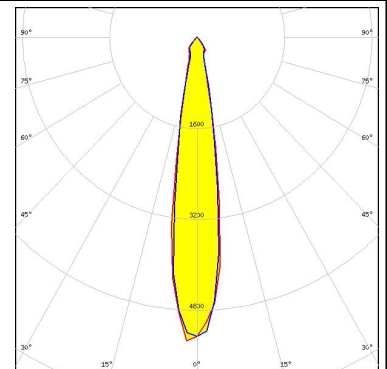

PHOTOMETRIC DATA (MEASURED):

CREE

LED MT-G
 FWHM / FWTM 19.0° / 46.0°
 Efficiency 85 %
 Peak intensity 4.4 cd/lm
 LEDs/each optic 1
 Light colour White
 Required components:
 C13083_PF-SOCKET
 C12479_MIRELLA-DL



CREE

LED MT-G2
 FWHM / FWTM 16.0° / 33.0°
 Efficiency 84 %
 Peak intensity 5.8 cd/lm
 LEDs/each optic 1
 Light colour White
 Required components:
 C13083_PF-SOCKET
 C13333_MIRELLA-CL



CREE

LED MT-G2
 FWHM / FWTM 18.0° / 35.0°
 Efficiency 88 %
 Peak intensity 4.2 cd/lm
 LEDs/each optic 1
 Light colour White
 Required components:
 C13083_PF-SOCKET

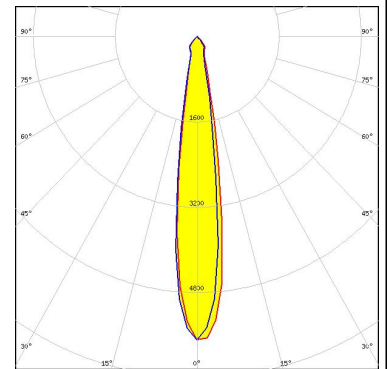

CREE

LED MT-G2
 FWHM / FWTM 18.0° / 43.0°
 Efficiency 85 %
 Peak intensity 4.6 cd/lm
 LEDs/each optic 1
 Light colour White
 Required components:
 C13083_PF-SOCKET
 C12479_MIRELLA-DL



PHOTOMETRIC DATA (MEASURED):

CREE 

LED XHP50
 FWHM / FWTM 11.0° / 23.0°
 Efficiency 89 %
 Peak intensity 9.2 cd/lm
 LEDs/each optic 1
 Light colour White
 Required components:
 C13083_PF-SOCKET

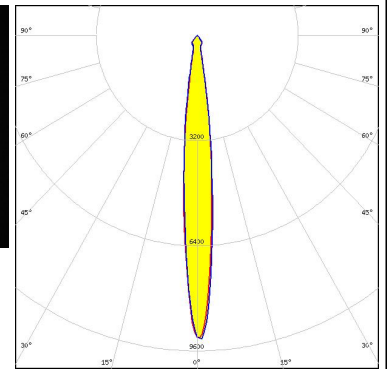

CREE 

LED XHP50
 FWHM / FWTM 22.0° / 60.0°
 Efficiency 81 %
 Peak intensity 2.6 cd/lm
 LEDs/each optic 1
 Light colour White
 Required components:
 C13083_PF-SOCKET
 C13723_MIRELLA-RZL

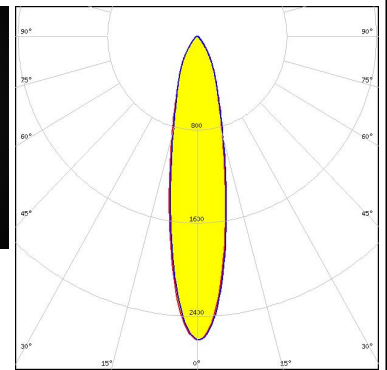
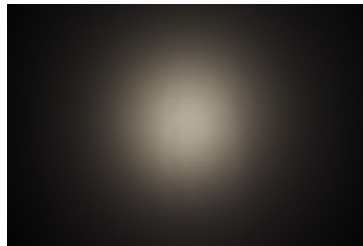

CREE 

LED XHP50
 FWHM / FWTM 15.0° / 34.0°
 Efficiency 85 %
 Peak intensity 5.3 cd/lm
 LEDs/each optic 1
 Light colour White
 Required components:
 C13083_PF-SOCKET
 C12479_MIRELLA-DL

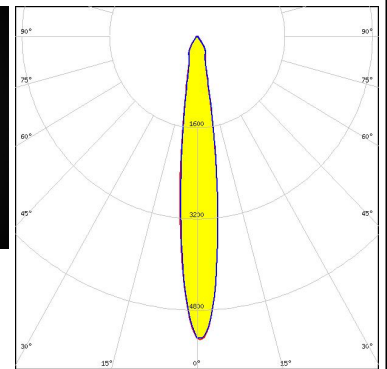

CREE 

LED XHP50
 FWHM / FWTM 12.0° / 25.0°
 Efficiency 84 %
 Peak intensity 7.6 cd/lm
 LEDs/each optic 1
 Light colour White
 Required components:
 C13083_PF-SOCKET
 C13333_MIRELLA-CL

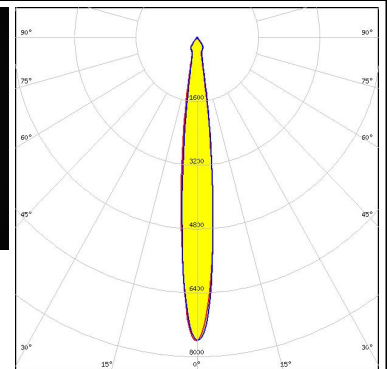

PHOTOMETRIC DATA (MEASURED):



LED XHP70
 FWHM / FWTM 24.0° / 62.0°
 Efficiency 81 %
 Peak intensity 2.4 cd/lm
 LEDs/each optic 1
 Light colour White
 Required components:
 C13083_PF-SOCKET
 C13723_MIRELLA-RZL

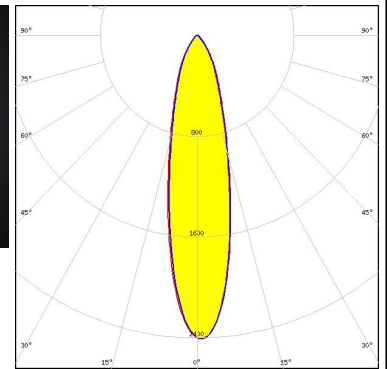
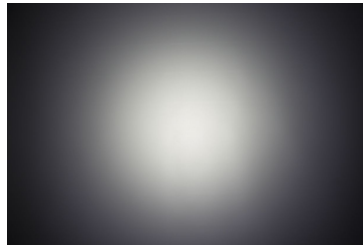

LED XHP70
 FWHM / FWTM 15.0° / 31.0°
 Efficiency 89 %
 Peak intensity 0.6 cd/lm
 LEDs/each optic 1
 Light colour White
 Required components:
 C13083_PF-SOCKET

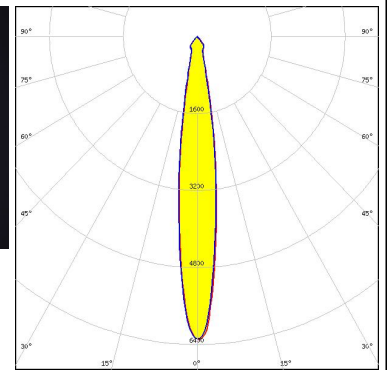
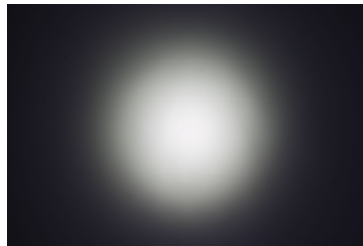

LED XHP70
 FWHM / FWTM 17.0° / 40.0°
 Efficiency 84 %
 Peak intensity 4.3 cd/lm
 LEDs/each optic 1
 Light colour White
 Required components:
 C13083_PF-SOCKET
 C12479_MIRELLA-DL

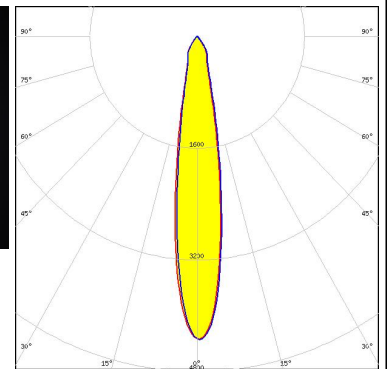
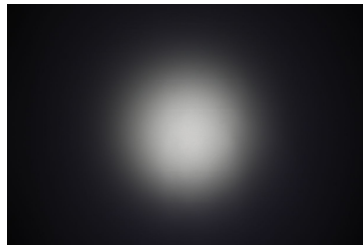

LED XHP70
 FWHM / FWTM 16.0° / 32.0°
 Efficiency 83 %
 Peak intensity 5.3 cd/lm
 LEDs/each optic 1
 Light colour White
 Required components:
 C13083_PF-SOCKET
 C13333_MIRELLA-CL

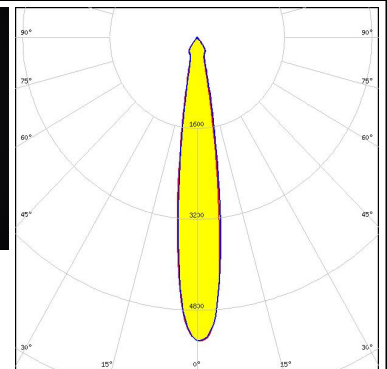

PHOTOMETRIC DATA (MEASURED):



LED XM-L RGB
 FWHM / FWTM 22.0° / 55.0°
 Efficiency 80 %
 Peak intensity 3.1 cd/lm
 LEDs/each optic 1
 Light colour White
 Required components:
 C13083_PF-SOCKET
 C13723_MIRELLA-RZL

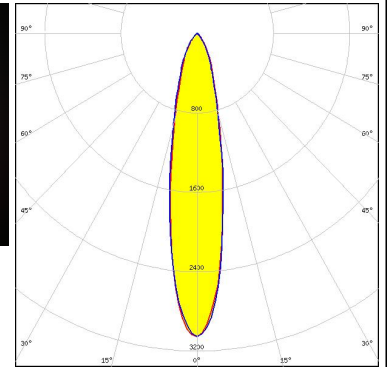
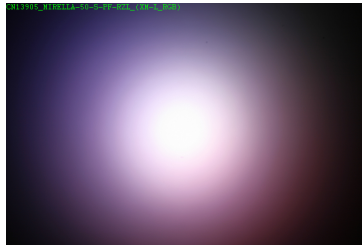

LED XQ-E HI
 FWHM / FWTM 21.0° / 58.0°
 Efficiency 86 %
 Peak intensity 3.1 cd/lm
 LEDs/each optic 4
 Light colour RGBW
 Required components:
 C13083_PF-SOCKET
 C13723_MIRELLA-RZL

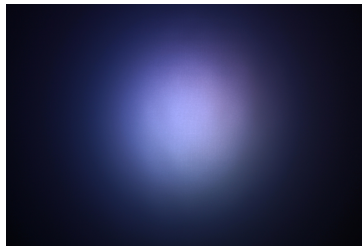

LED LUXEON CoB 1202/1203
 FWHM / FWTM 20.0° / 61.0°
 Efficiency 78 %
 Peak intensity 3.1 cd/lm
 LEDs/each optic 1
 Light colour White
 Required components:
 C13709_PF-SOCKET-VERO13-18
 C13333_MIRELLA-CL
 Bender Wirth: 438 Typ L1

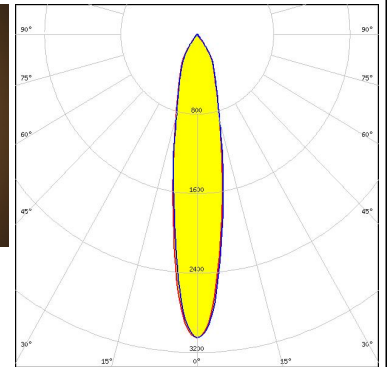
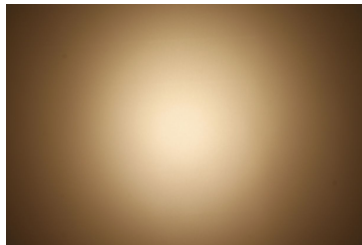

LED LUXEON CoB 1202/1203
 FWHM / FWTM 19.0° / 50.0°
 Efficiency 87 %
 Peak intensity 4 cd/lm
 LEDs/each optic 1
 Light colour White
 Required components:
 C14037_PF-NSX-SOCKET

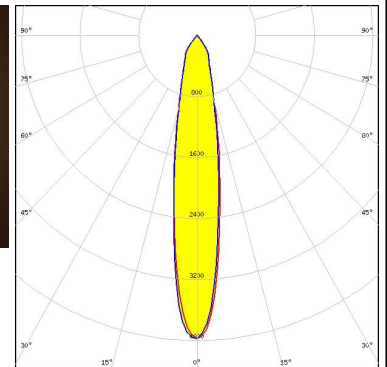
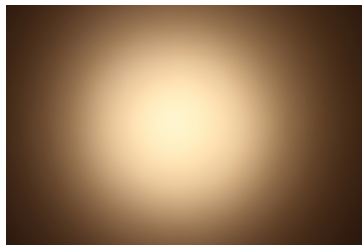

PHOTOMETRIC DATA (MEASURED):

LUMILEDS

LED LUXEON CoB 1202/1203
 FWHM / FWTM 19.0° / 58.0°
 Efficiency 88 %
 Peak intensity 3.5 cd/m
 LEDs/each optic 1
 Light colour White
 Required components:
 IDEAL: 50-2100NC +50-2100MR

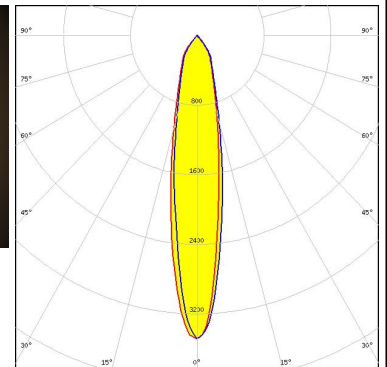

LUMILEDS

LED LUXEON CoB 1202/1203
 FWHM / FWTM 19.0° / 59.0°
 Efficiency 82 %
 Peak intensity 3.3 cd/m
 LEDs/each optic 1
 Light colour White
 Required components:
 C13333_MIRELLA-CL
 IDEAL: 50-2100NC +50-2100MR

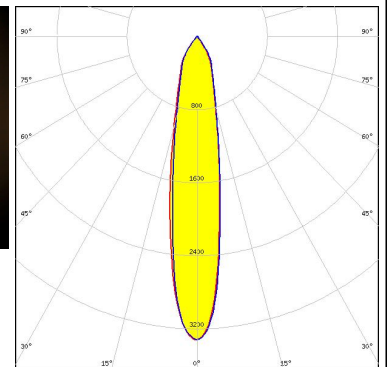
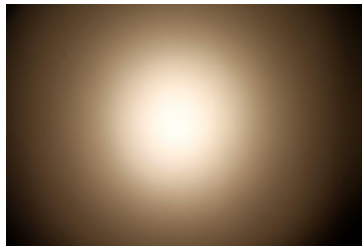

LUMILEDS

LED LUXEON CoB 1202/1203
 FWHM / FWTM 22.0° / 61.0°
 Efficiency 83 %
 Peak intensity 2.9 cd/m
 LEDs/each optic 1
 Light colour White
 Required components:
 C12479_MIRELLA-DL
 IDEAL: 50-2100NC +50-2100MR

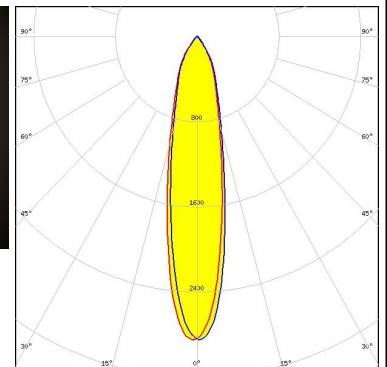
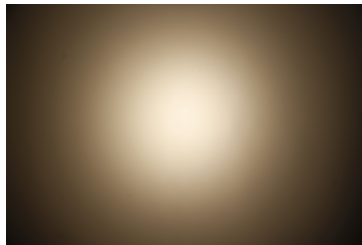



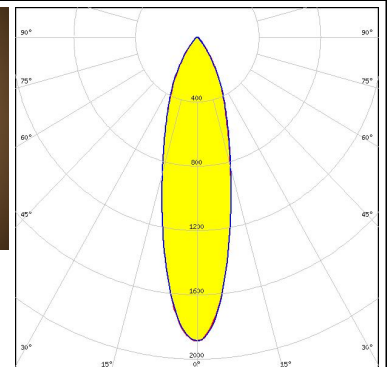
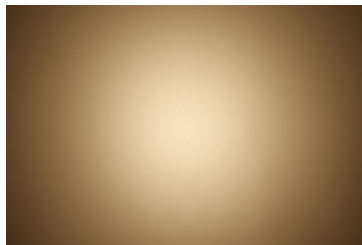

LUMILEDS

LED LUXEON CoB 1202/1203
 FWHM / FWTM 27.0° / 67.0°
 Efficiency 76 %
 Peak intensity 1.9 cd/m
 LEDs/each optic 1
 Light colour White
 Required components:
 C13709_PF-SOCKET-VERO13-18
 C12479_MIRELLA-DL
 Bender Wirth: 438 Typ L1

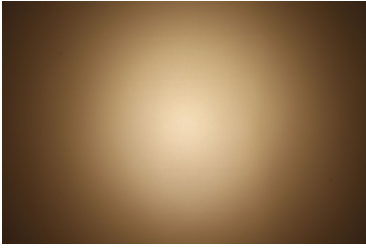
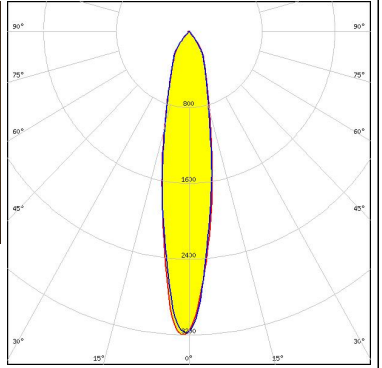

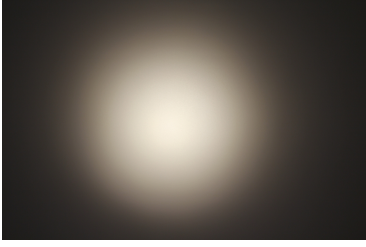
PHOTOMETRIC DATA (MEASURED):

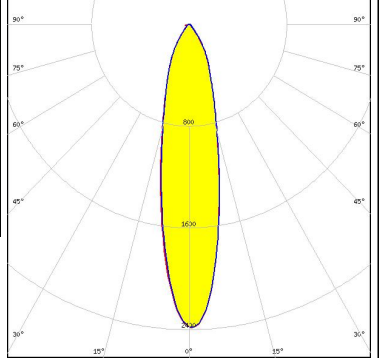
<p>LUMILEDS</p> <p>LED LUXEON CoB 1202/1203</p> <p>FWHM / FWTM 20.0° / 61.0°</p> <p>Efficiency 84 %</p> <p>Peak intensity 3.2 cd/lm</p> <p>LEDs/each optic 1</p> <p>Light colour White</p> <p>Required components: C13709_PF-SOCKET-VERO13-18 Bender Wirth: 438 Typ L1</p>		
<p>LUMILEDS</p> <p>LED LUXEON CoB 1202s</p> <p>FWHM / FWTM 15.0° / 36.0°</p> <p>Efficiency 84 %</p> <p>Peak intensity 5.9 cd/lm</p> <p>LEDs/each optic 1</p> <p>Light colour White</p> <p>Required components: C13761_PF-SOCKET-CXA15 C12479_MIRELLA-DL</p>		
<p>LUMILEDS</p> <p>LED LUXEON CoB 1202s</p> <p>FWHM / FWTM 13.0° / 30.0°</p> <p>Efficiency 89 %</p> <p>Peak intensity 7.9 cd/lm</p> <p>LEDs/each optic 1</p> <p>Light colour White</p> <p>Required components: C13761_PF-SOCKET-CXA15</p>		
<p>LUMILEDS</p> <p>LED LUXEON CoB 1202s</p> <p>FWHM / FWTM 23.0° / 63.0°</p> <p>Efficiency 79 %</p> <p>Peak intensity 2.4 cd/lm</p> <p>LEDs/each optic 1</p> <p>Light colour White</p> <p>Required components: C13709_PF-SOCKET-VERO13-18 C12479_MIRELLA-DL Bender Wirth: 452 Typ L1</p>		

PHOTOMETRIC DATA (MEASURED):

LUMILEDS

LED LUXEON CoB 1202s
 FWHM / FWTM 13.0° / 28.0°
 Efficiency 84 %
 Peak intensity 7.6 cd/lm
 LEDs/each optic 1
 Light colour White
 Required components:
 C13761_PF-SOCKET-CXA15
 C13333_MIRELLA-CL



LUMILEDS

LED LUXEON Z
 FWHM / FWTM 21.0° / 54.0°
 Efficiency 78 %
 Peak intensity 3.2 cd/lm
 LEDs/each optic 4
 Light colour RGBW
 Required components:
 C13083_PF-SOCKET
 C13723_MIRELLA-RZL

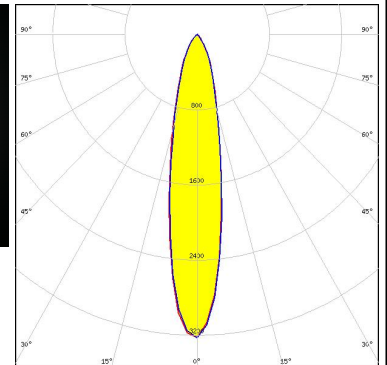
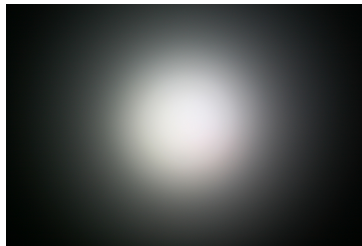

LUMINUS

LED CxM-6 (12x13)
 FWHM / FWTM 14.0° / 32.0°
 Efficiency 86 %
 Peak intensity 6.7 cd/lm
 LEDs/each optic 1
 Light colour White
 Required components:
 C13083_PF-SOCKET

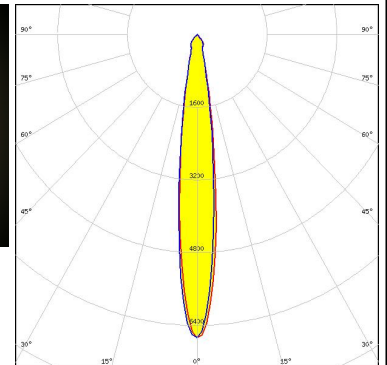

LUMINUS

LED CXM-7 (13x13)
 FWHM / FWTM 17.0° / 38.0°
 Efficiency 87 %
 Peak intensity 5.1 cd/lm
 LEDs/each optic 1
 Light colour White
 Required components:
 C13083_PF-SOCKET

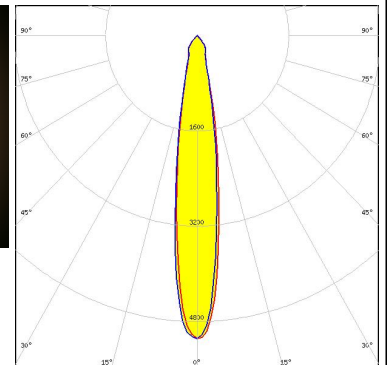

PHOTOMETRIC DATA (MEASURED):



LED CxM-9 (13.5x13.5)
 FWHM / FWTM 30.0° / 70.0°
 Efficiency 81 %
 Peak intensity 1.8 cd/lm
 LEDs/each optic 1
 Light colour White
 Required components:
 C13083_PF-SOCKET
 C13723_MIRELLA-RZL

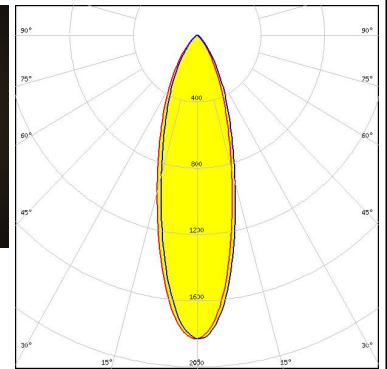
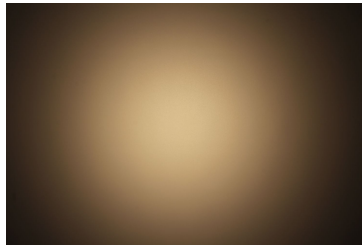

LED CxM-9 (13.5x13.5)
 FWHM / FWTM 23.0° / 61.0°
 Efficiency 86 %
 Peak intensity 2.9 cd/lm
 LEDs/each optic 1
 Light colour White
 Required components:
 C13083_PF-SOCKET
 C12479_MIRELLA-DL

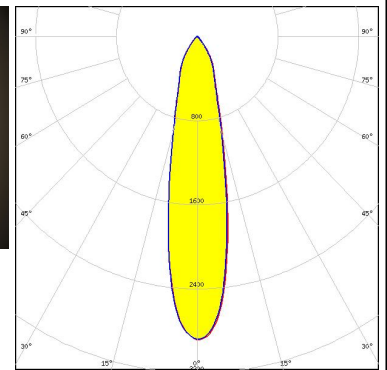
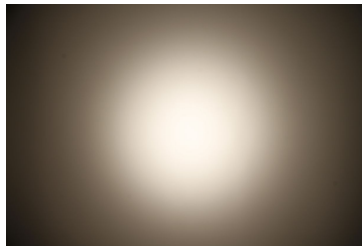

LED CxM-9 (13.5x13.5)
 FWHM / FWTM 21.0° / 58.0°
 Efficiency 85 %
 Peak intensity 3.3 cd/lm
 LEDs/each optic 1
 Light colour White
 Required components:
 C13083_PF-SOCKET
 C13333_MIRELLA-CL

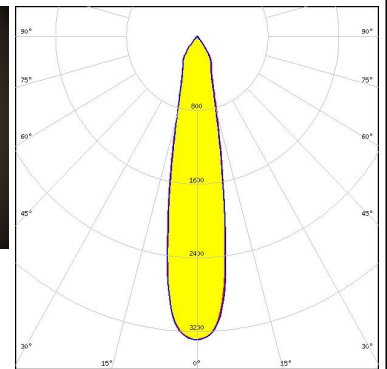

LED COB L-Type (LES 11)
 FWHM / FWTM 24.0° / 65.0°
 Efficiency 78 %
 Peak intensity 2.4 cd/lm
 LEDs/each optic 1
 Light colour White
 Required components:
 C13709_PF-SOCKET-VERO13-18
 C13333_MIRELLA-CL
 Bender Wirth: 438 Typ L1

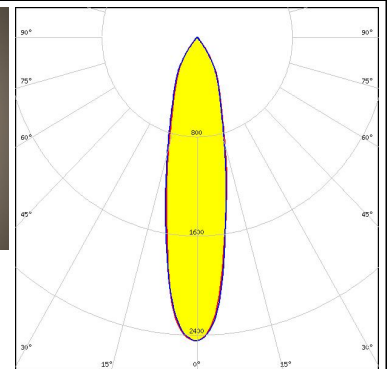
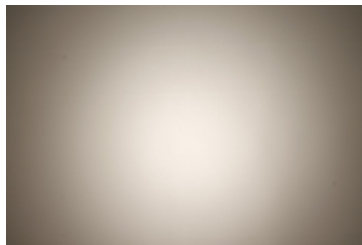

PHOTOMETRIC DATA (MEASURED):



LED COB L-Type (LES 11)
 FWHM / FWTM 25.0° / 68.0°
 Efficiency 83 %
 Peak intensity 2.5 cd/m
 LEDs/each optic 1
 Light colour White
 Required components:
 IDEAL: 50-2100NC +50-2100MR

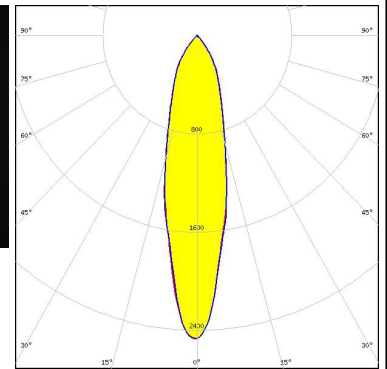
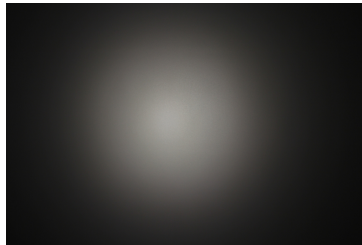

LED COB L-Type (LES 11)
 FWHM / FWTM 25.0° / 68.0°
 Efficiency 86 %
 Peak intensity 2.5 cd/m
 LEDs/each optic 1
 Light colour White
 Required components:
 C14037_PF-NSX-SOCKET

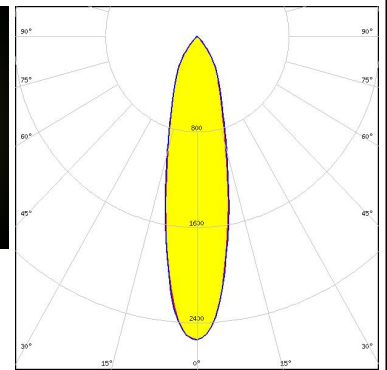
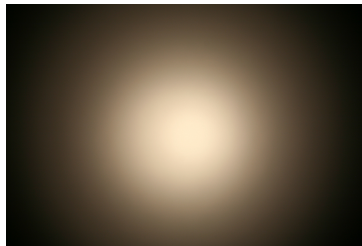



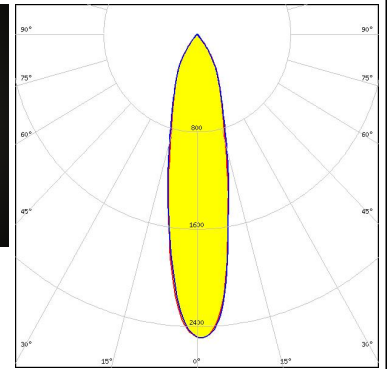
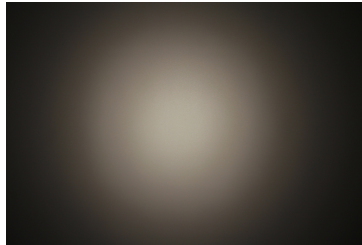

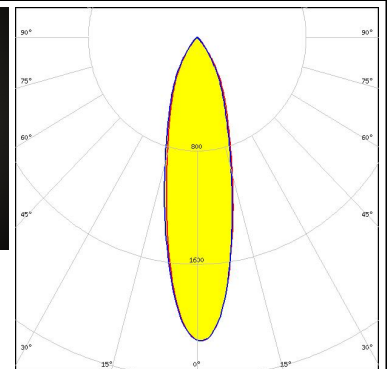
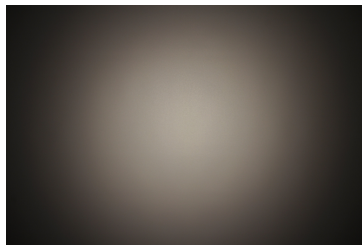

LED COB L-Type (LES 11)
 FWHM / FWTM 24.0° / 65.0°
 Efficiency 81 %
 Peak intensity 2.5 cd/m
 LEDs/each optic 1
 Light colour White
 Required components:
 C13333_MIRELLA-CL
 IDEAL: 50-2100NC +50-2100MR



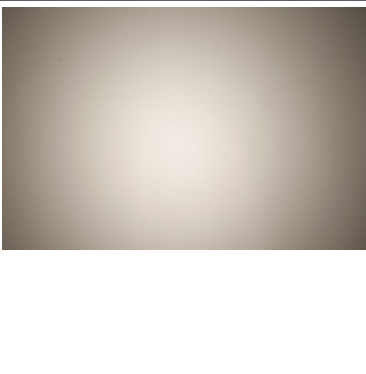
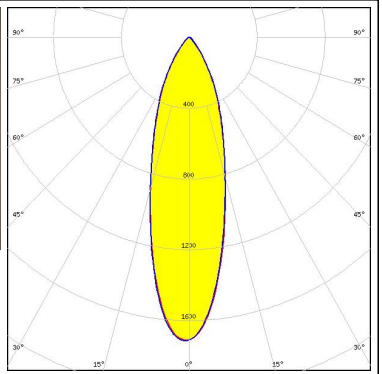

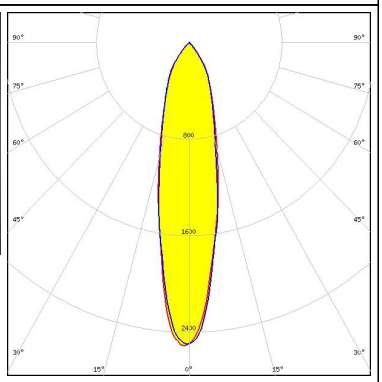
LED COB L-Type (LES 11)
 FWHM / FWTM 26.0° / 67.0°
 Efficiency 80 %
 Peak intensity 2.1 cd/m
 LEDs/each optic 1
 Light colour White
 Required components:
 C12479_MIRELLA-DL
 IDEAL: 50-2100NC +50-2100MR

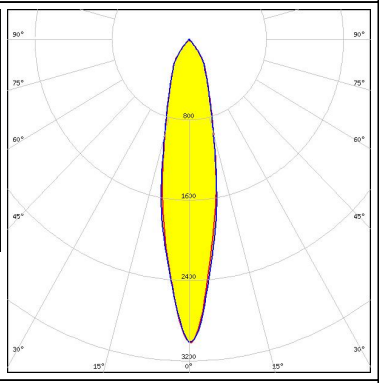

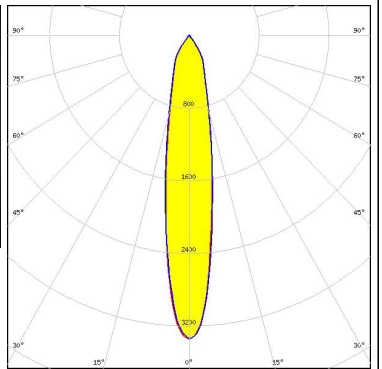
PHOTOMETRIC DATA (MEASURED):

<p>NICHIA</p> <p>LED COB L-Type (LES 11)</p> <p>FWHM / FWTM 30.0° / 70.0°</p> <p>Efficiency 76 %</p> <p>Peak intensity 1.7 cd/lm</p> <p>LEDs/each optic 1</p> <p>Light colour White</p> <p>Required components:</p> <p>C13709_PF-SOCKET-VERO13-18</p> <p>C12479_MIRELLA-DL</p> <p>Bender Wirth: 438 Typ L1</p>		
<p>NICHIA</p> <p>LED COB L-Type (LES 11)</p> <p>FWHM / FWTM 24.0° / 68.0°</p> <p>Efficiency 81 %</p> <p>Peak intensity 2.5 cd/lm</p> <p>LEDs/each optic 1</p> <p>Light colour White</p> <p>Required components:</p> <p>C13709_PF-SOCKET-VERO13-18</p> <p>Bender Wirth: 438 Typ L1</p>		
<p>NICHIA</p> <p>LED COB L-Type (LES 9)</p> <p>FWHM / FWTM 22.0° / 64.0°</p> <p>Efficiency 84 %</p> <p>Peak intensity 3 cd/lm</p> <p>LEDs/each optic 1</p> <p>Light colour White</p> <p>Required components:</p> <p>IDEAL: 50-2100NC +50-2100MR</p>		
<p>NICHIA</p> <p>LED COB L-Type (LES 9)</p> <p>FWHM / FWTM 18.0° / 58.0°</p> <p>Efficiency 80 %</p> <p>Peak intensity 3.3 cd/lm</p> <p>LEDs/each optic 1</p> <p>Light colour White</p> <p>Required components:</p> <p>C13709_PF-SOCKET-VERO13-18</p> <p>C13333_MIRELLA-CL</p> <p>Bender Wirth: 438 Typ L1</p>		

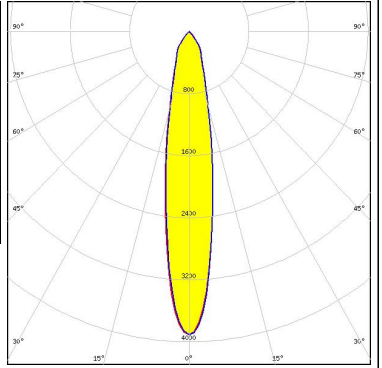
PHOTOMETRIC DATA (MEASURED):

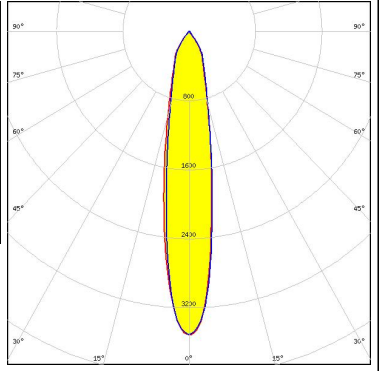
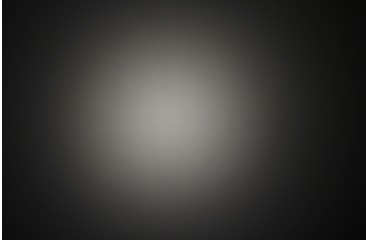
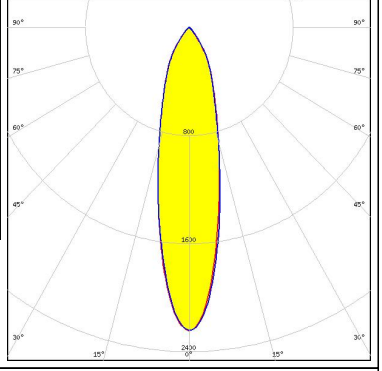
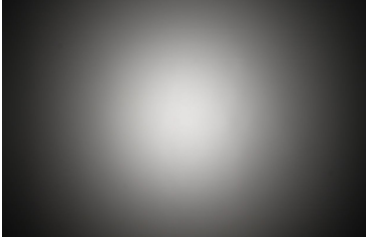
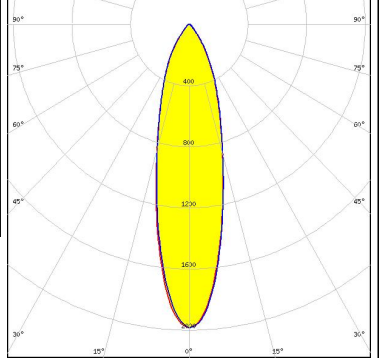
<p>NICHIA</p> <p>LED COB L-Type (LES 9)</p> <p>FWHM / FWTM 19.0° / 52.0°</p> <p>Efficiency 88 %</p> <p>Peak intensity 3.9 cd/lm</p> <p>LEDs/each optic 1</p> <p>Light colour White</p> <p>Required components: C14037_PF-NSX-SOCKET</p>		
<p>NICHIA</p> <p>LED COB L-Type (LES 9)</p> <p>FWHM / FWTM 18.0° / 56.0°</p> <p>Efficiency 83 %</p> <p>Peak intensity 3.5 cd/lm</p> <p>LEDs/each optic 1</p> <p>Light colour White</p> <p>Required components: C13333_MIRELLA-CL IDEAL: 50-2100NC +50-2100MR</p>		
<p>NICHIA</p> <p>LED COB L-Type (LES 9)</p> <p>FWHM / FWTM 24.0° / 66.0°</p> <p>Efficiency 78 %</p> <p>Peak intensity 2.2 cd/lm</p> <p>LEDs/each optic 1</p> <p>Light colour White</p> <p>Required components: C12479_MIRELLA-DL IDEAL: 50-2100NC +50-2100MR</p>		
<p>NICHIA</p> <p>LED COB L-Type (LES 9)</p> <p>FWHM / FWTM 27.0° / 67.0°</p> <p>Efficiency 77 %</p> <p>Peak intensity 2 cd/lm</p> <p>LEDs/each optic 1</p> <p>Light colour White</p> <p>Required components: C13709_PF-SOCKET-VERO13-18 C12479_MIRELLA-DL Bender Wirth: 438 Typ L1</p>		

PHOTOMETRIC DATA (MEASURED):



LED COB L-Type (LES 9)
 FWHM / FWTM 19.0° / 57.0°
 Efficiency 85 %
 Peak intensity 3.4 cd/lm
 LEDs/each optic 1
 Light colour White
 Required components:
 C13709_PF-SOCKET-VERO13-18
 Bender Wirth: 438 Typ L1

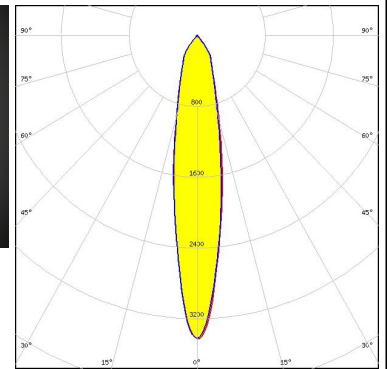
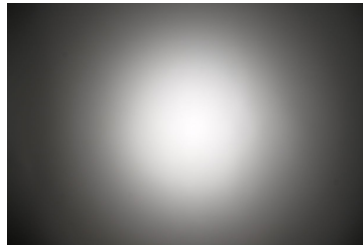

LED NSCxL036A
 FWHM / FWTM 16.0° / 38.0°
 Efficiency 86 %
 Peak intensity 5.1 cd/lm
 LEDs/each optic 1
 Light colour White
 Required components:
 C14037_PF-NSX-SOCKET



LED Duris S10
 FWHM / FWTM 13.0° / 31.0°
 Efficiency 87 %
 Peak intensity 6.6 cd/lm
 LEDs/each optic 1
 Light colour White
 Required components:
 C13083_PF-SOCKET

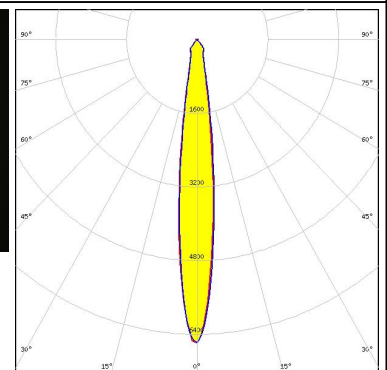
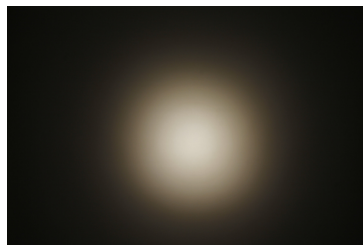

LED Duris S10
 FWHM / FWTM 22.0° / 61.0°
 Efficiency 82 %
 Peak intensity 3 cd/lm
 LEDs/each optic 1
 Light colour White
 Required components:
 C13083_PF-SOCKET
 C13723_MIRELLA-RZL

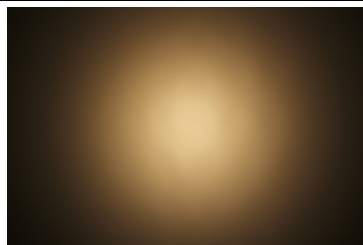

PHOTOMETRIC DATA (MEASURED):

OSRAM

Opto Semiconductors

LED Duris S10
 FWHM / FWTM 18.0° / 54.0°
 Efficiency 80 %
 Peak intensity 3.6 cd/m
 LEDs/each optic 1
 Light colour White

Required components:

C13083_PF-SOCKET
 C12479_MIRELLA-DL

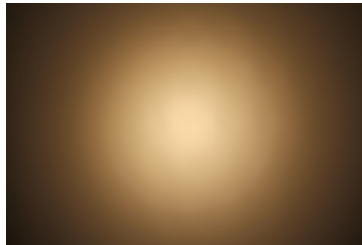

OSRAM

Opto Semiconductors

LED Duris S10
 FWHM / FWTM 13.0° / 30.0°
 Efficiency 81 %
 Peak intensity 6.5 cd/m
 LEDs/each optic 1
 Light colour White

Required components:

C13083_PF-SOCKET
 C13333_MIRELLA-CL

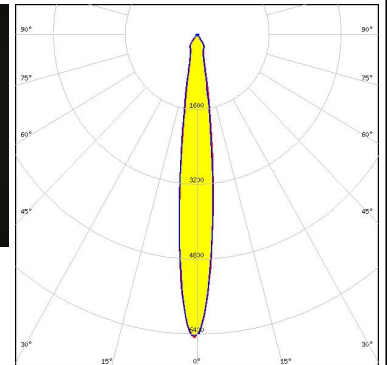

OSRAM

Opto Semiconductors

LED OSTAR Stage (S2WP)
 FWHM / FWTM 21.0° / 58.0°
 Efficiency 83 %
 Peak intensity 3.3 cd/m
 LEDs/each optic 1
 Light colour White

Required components:

C13083_PF-SOCKET
 C13723_MIRELLA-RZL

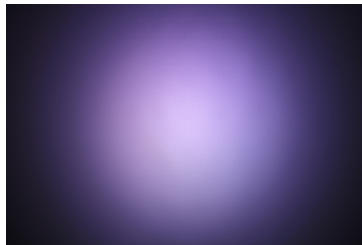

OSRAM

Opto Semiconductors





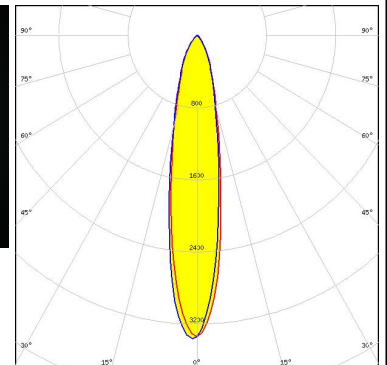
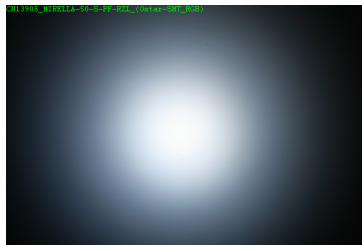

LED Ostar-SMT RGB
 FWHM / FWTM 20.0° / 55.0°
 Efficiency 82 %
 Peak intensity 3.4 cd/m
 LEDs/each optic 1
 Light colour White

Required components:

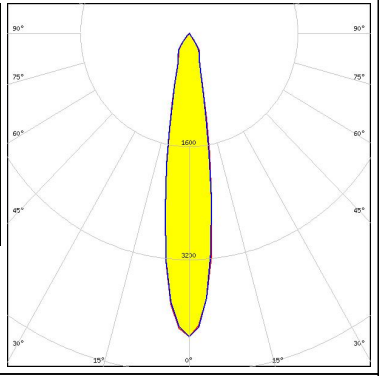
C13083_PF-SOCKET
 C13723_MIRELLA-RZL

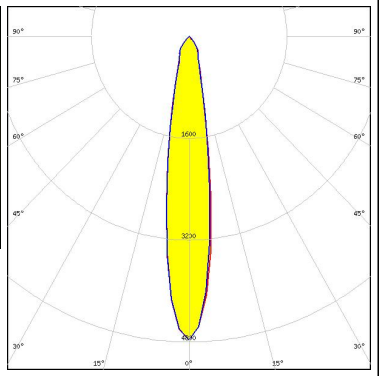

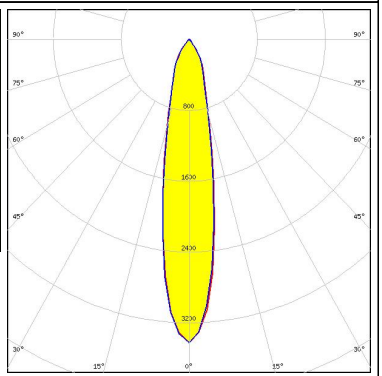
PHOTOMETRIC DATA (MEASURED):

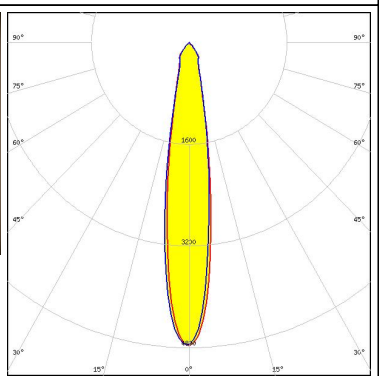
<p>SEOUL SEMICONDUCTOR</p> <p>LED ZC4/6</p> <p>FWHM / FWTM 19.0° / 44.0°</p> <p>Efficiency 83 %</p> <p>Peak intensity 4.3 cd/m</p> <p>LEDs/each optic 1</p> <p>Light colour White</p> <p>Required components: C13083_PF-SOCKET C13333_MIRELLA-CL</p>		
<p>SEOUL SEMICONDUCTOR</p> <p>LED ZC4/6</p> <p>FWHM / FWTM 18.0° / 42.0°</p> <p>Efficiency 88 %</p> <p>Peak intensity 4.8 cd/m</p> <p>LEDs/each optic 1</p> <p>Light colour White</p> <p>Required components: C13083_PF-SOCKET</p>		
<p>SEOUL SEMICONDUCTOR</p> <p>LED ZC4/6</p> <p>FWHM / FWTM 21.0° / 56.0°</p> <p>Efficiency 83 %</p> <p>Peak intensity 3.4 cd/m</p> <p>LEDs/each optic 1</p> <p>Light colour White</p> <p>Required components: C13083_PF-SOCKET C12479_MIRELLA-DL</p>		
<p>SHARP</p> <p>LED Mini Zenigata (GW6BM)</p> <p>FWHM / FWTM 17.0° / 41.0°</p> <p>Efficiency 91 %</p> <p>Peak intensity 4.8 cd/m</p> <p>LEDs/each optic 1</p> <p>Light colour White</p> <p>Required components: C13083_PF-SOCKET</p>		

PHOTOMETRIC DATA (MEASURED):

SHARP

LED Mini Zenigata (GW6BM)
FWHM / FWTM 20.0° / 56.0°
Efficiency 84 %
Peak intensity 3.2 cd/lm
LEDs/each optic 1
Light colour White
Required components:
C13083_PF-SOCKET
C12479_MIRELLA-DL

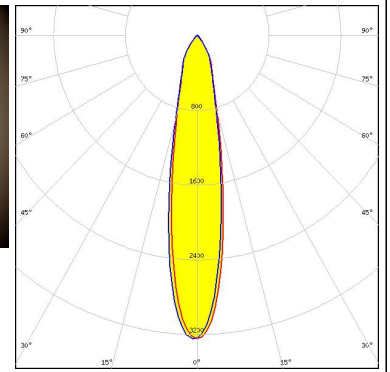
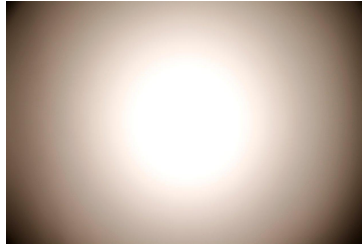

XICATO

LED XTM - 9mm LES
FWHM / FWTM 20.0° / 61.0°
Efficiency 82 %
Peak intensity 3.2 cd/lm
LEDs/each optic 1
Light colour White
Required components:
C14636_XTM-PF-ADAPTER

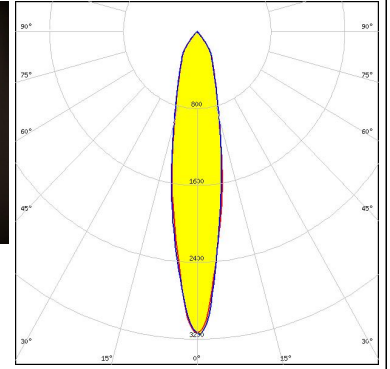
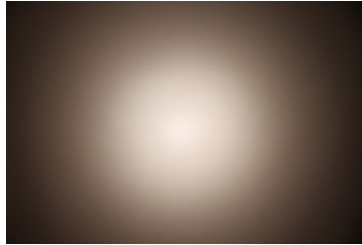

PHOTOMETRIC DATA (SIMULATED):



LED XHP50.2
 FWHM / FWTM 11.0° / 22.0°
 Efficiency 90 %
 Peak intensity 11.2 cd/lm
 LEDs/each optic 1
 Light colour White
 Required components:

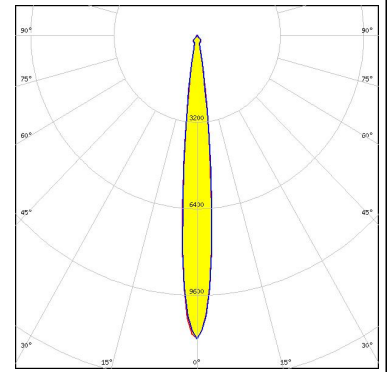

LED LUXEON CoB Compact
 FWHM / FWTM 13.0° / 30.0°
 Efficiency 89 %
 Peak intensity 7.9 cd/lm
 LEDs/each optic 1
 Light colour White
 Required components:
 C13761_PF-SOCKET-CXA15



LED LUXEON CoB Compact
 FWHM / FWTM 13.0° / 28.0°
 Efficiency 84 %
 Peak intensity 7.6 cd/lm
 LEDs/each optic 1
 Light colour White
 Required components:
 C13761_PF-SOCKET-CXA15
 C13333_MIRELLA-CL



LED LUXEON CoB Compact
 FWHM / FWTM 15.0° / 36.0°
 Efficiency 84 %
 Peak intensity 4.8 cd/lm
 LEDs/each optic 1
 Light colour White
 Required components:
 C13761_PF-SOCKET-CXA15
 C12479_MIRELLA-DL

PHOTOMETRIC DATA (SIMULATED):

LUMILEDS

LED LUXEON CoB Compact
 FWHM / FWTM 23.0° / 63.0°
 Efficiency 79 %
 Peak intensity 2.4 cd/lm
 LEDs/each optic 1
 Light colour White
 Required components:
 C13709_PF-SOCKET-VERO13-18
 C12479_MIRELLA-DL
 Bender Wirth: 452 Typ L1

LUMILEDS

LED LUXEON K4
 FWHM / FWTM 24.0° / 72.0°
 Efficiency 88 %
 Peak intensity 2.9 cd/lm
 LEDs/each optic 1
 Light colour White
 Required components:
 C13761_PF-SOCKET-CXA15

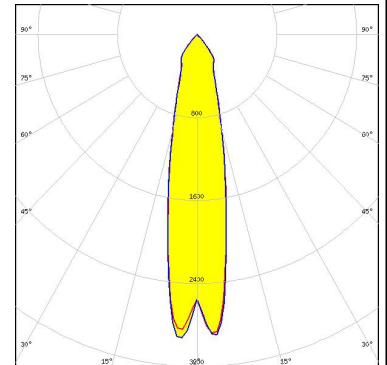

LUMILEDS

LED LUXEON K4
 FWHM / FWTM 42.0° / 87.0°
 Efficiency 84 %
 Peak intensity 1.2 cd/lm
 LEDs/each optic 1
 Light colour White
 Required components:
 C13761_PF-SOCKET-CXA15
 C12479_MIRELLA-DL

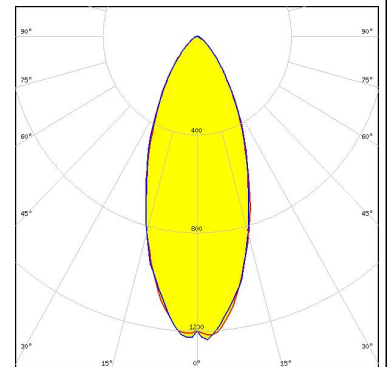

LUMINUS

LED CxM-14 (19x19)
 FWHM / FWTM 31.0° / 70.0°
 Efficiency 72 %
 Peak intensity 1.7 cd/lm
 LEDs/each optic 1
 Light colour White
 Required components:
 C13709_PF-SOCKET-VERO13-18
 C13333_MIRELLA-CL
 Bender Wirth: 433 Typ L1

PHOTOMETRIC DATA (SIMULATED):

LUMINUS

LED CxM-14 (19x19)
FWHM / FWTM 29.0° / 72.0°
Efficiency 76 %
Peak intensity 1.8 cd/lm
LEDs/each optic 1
Light colour White
Required components:
C13709_PF-SOCKET-VERO13-18

LUMINUS

LED CxM-14 (19x19)
FWHM / FWTM 33.0° / 72.0°
Efficiency 69 %
Peak intensity 1.4 cd/lm
LEDs/each optic 1
Light colour White
Required components:
C13709_PF-SOCKET-VERO13-18
C12479_MIRELLA-DL
Bender Wirth: 433 Typ L1

LUMINUS

LED CxM-9 (13.5x13.5)
FWHM / FWTM 20.0° / 61.0°
Efficiency 80 %
Peak intensity 3.1 cd/lm
LEDs/each optic 1
Light colour White
Required components:
C13709_PF-SOCKET-VERO13-18
C13333_MIRELLA-CL
Bender Wirth: 434 Typ L1

LUMINUS

LED CxM-9 (13.5x13.5)
FWHM / FWTM 21.0° / 63.0°
Efficiency 84 %
Peak intensity 3.1 cd/lm
LEDs/each optic 1
Light colour White
Required components:
C13709_PF-SOCKET-VERO13-18
Bender Wirth: 434 Typ L1

PHOTOMETRIC DATA (SIMULATED):



LED CxM-9 (13.5x13.5)
FWHM / FWTM 27.0° / 67.0°
Efficiency 77 %
Peak intensity 2 cd/lm
LEDs/each optic 1
Light colour White
Required components:
C13709_PF-SOCKET-VERO13-18
C12479_MIRELLA-DL
Bender Wirth: 434 Typ L1



LED COB S-Type (LES 7)
FWHM / FWTM 15.0° / 41.0°
Efficiency 83 %
Peak intensity 4.9 cd/lm
LEDs/each optic 1
Light colour White
Required components:
C13709_PF-SOCKET-VERO13-18
C13333_MIRELLA-CL
Bender Wirth: 452 Typ L1



LED COB S-Type (LES 7)
FWHM / FWTM 19.0° / 49.0°
Efficiency 87 %
Peak intensity 3.9 cd/lm
LEDs/each optic 1
Light colour White
Required components:
C13709_PF-SOCKET-VERO13-18
Bender Wirth: 452 Typ L1



LED COB S-Type (LES 7)
FWHM / FWTM 23.0° / 63.0°
Efficiency 79 %
Peak intensity 2.4 cd/lm
LEDs/each optic 1
Light colour White
Required components:
C13709_PF-SOCKET-VERO13-18
C12479_MIRELLA-DL
Bender Wirth: 452 Typ L1

PHOTOMETRIC DATA (SIMULATED):

OSRAM

Opto Semiconductors

LED Duris S8
 FWHM / FWTM 14.0° / 29.0°
 Efficiency 90 %
 Peak intensity 7.4 cd/lm
 LEDs/each optic 1
 Light colour White
 Required components:
 C13083_PF-SOCKET
 C12479_MIRELLA-DL

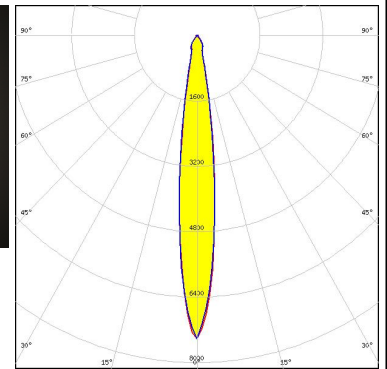
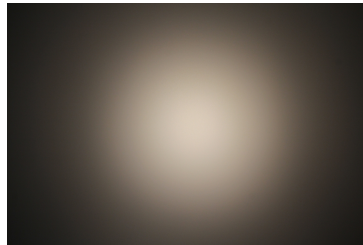

OSRAM

Opto Semiconductors

LED Duris S8
 FWHM / FWTM 9.5° / 24.0°
 Efficiency 94 %
 Peak intensity 12.5 cd/lm
 LEDs/each optic 1
 Light colour White
 Required components:
 C13083_PF-SOCKET

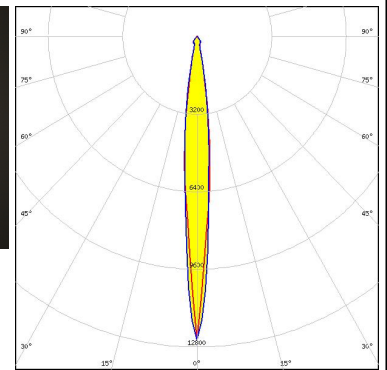

OSRAM

Opto Semiconductors

LED Soleriq S15
 FWHM / FWTM 28.0° / 74.0°
 Efficiency 85 %
 Peak intensity 2 cd/lm
 LEDs/each optic 1
 Light colour White
 Required components:
 C13709_PF-SOCKET-VERO13-18
 Bender Wirth: 433 Typ L1

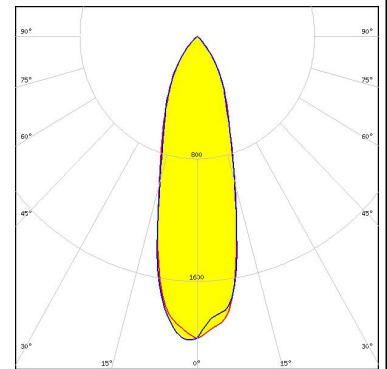

OSRAM

Opto Semiconductors

LED Soleriq S9
 FWHM / FWTM 24.0° / 61.0°
 Efficiency 87 %
 Peak intensity 2.9 cd/lm
 LEDs/each optic 1
 Light colour White
 Required components:
 C13083_PF-SOCKET
 C13333_MIRELLA-CL

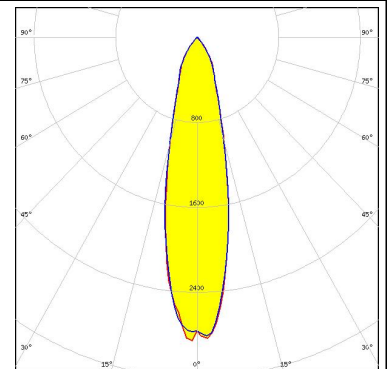

PHOTOMETRIC DATA (SIMULATED):

OSRAM

Opto Semiconductors

LED Soleriq S9
 FWHM / FWTM 24.0° / 61.0°
 Efficiency 86 %
 Peak intensity 2.9 cd/lm
 LEDs/each optic 1
 Light colour White
 Required components:
 C13083_PF-SOCKET
 C12479_MIRELLA-DL

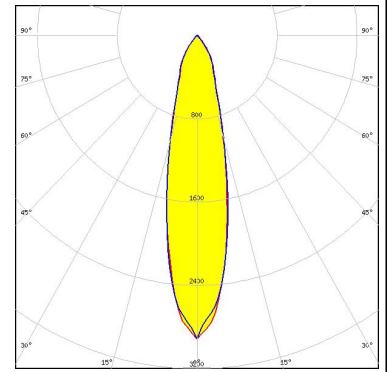

OSRAM

Opto Semiconductors

LED Soleriq S9
 FWHM / FWTM 19.0° / 56.0°
 Efficiency 87 %
 Peak intensity 3.7 cd/lm
 LEDs/each optic 1
 Light colour White
 Required components:
 C13709_PF-SOCKET-VERO13-18
 Bender Wirth: 434 Typ L1

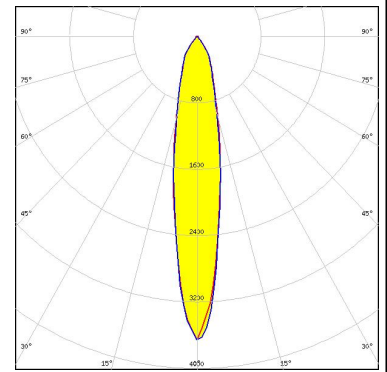

OSRAM

Opto Semiconductors

LED Soleriq S9
 FWHM / FWTM 21.0° / 54.0°
 Efficiency 91 %
 Peak intensity 3.5 cd/lm
 LEDs/each optic 1
 Light colour White
 Required components:
 C13083_PF-SOCKET

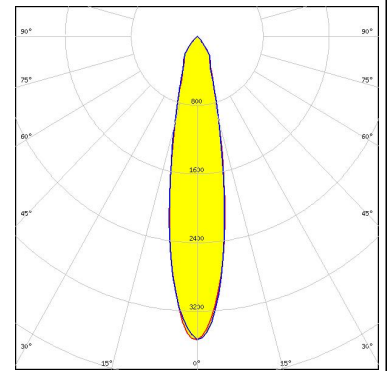

SAMSUNG

LED LC010C
 FWHM / FWTM 16.0° / 41.0°
 Efficiency 87 %
 Peak intensity 4.8 cd/lm
 LEDs/each optic 1
 Light colour White
 Required components:
 C13709_PF-SOCKET-VERO13-18
 Bender Wirth: 479 Typ L1

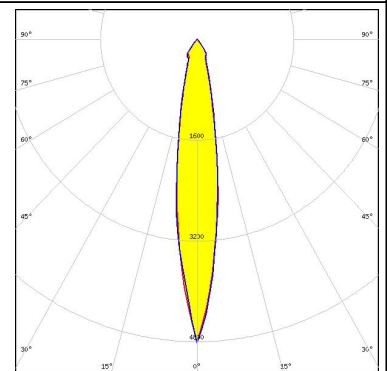

PHOTOMETRIC DATA (SIMULATED):

SAMSUNG

LED LC020C
 FWHM / FWTM 16.0° / 49.0°
 Efficiency 86 %
 Peak intensity 4.1 cd/lm
 LEDs/each optic 1
 Light colour White
 Required components:
 C13709_PF-SOCKET-VERO13-18
 Bender Wirth: 479 Typ L1

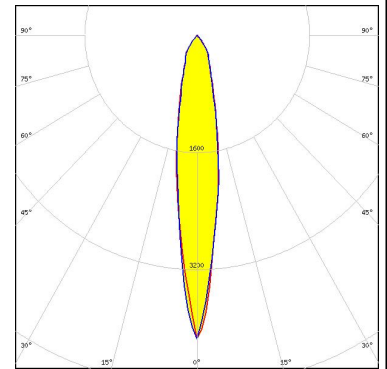

SAMSUNG

LED LC040C
 FWHM / FWTM 23.0° / 66.0°
 Efficiency 84 %
 Peak intensity 2.6 cd/lm
 LEDs/each optic 1
 Light colour White
 Required components:
 C13709_PF-SOCKET-VERO13-18
 Bender Wirth: 480 Typ L1

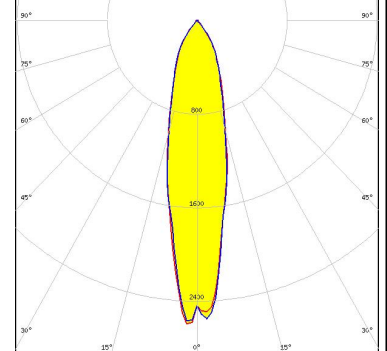

SEOUL SEMICONDUCTOR

LED ZC4/6
 FWHM / FWTM 20.0° / 61.0°
 Efficiency 80 %
 Peak intensity 3.1 cd/lm
 LEDs/each optic 1
 Light colour White
 Required components:
 C13709_PF-SOCKET-VERO13-18
 C13333_MIRELLA-CL
 Bender Wirth: 434 Typ L1



SEOUL SEMICONDUCTOR

LED ZC4/6
 FWHM / FWTM 21.0° / 63.0°
 Efficiency 84 %
 Peak intensity 3.1 cd/lm
 LEDs/each optic 1
 Light colour White
 Required components:
 C13709_PF-SOCKET-VERO13-18
 Bender Wirth: 434 Typ L1

PHOTOMETRIC DATA (SIMULATED):

	
SEOUL SEMICONDUCTOR	
LED	ZC4/6
FWHM / FWTM	27.0° / 67.0°
Efficiency	77 %
Peak intensity	2 cd/lm
LEDs/each optic	1
Light colour	White
Required components:	
C13709_PF-SOCKET-VERO13-18	
C12479_MIRELLA-DL	
Bender Wirth: 434 Typ L1	

GENERAL INFORMATION:

NOTE: The typical beam angle will be changed by different color, chip size and chip position tolerance. The typical total beam angle is the full angle measured where the luminous intensity is half of the peak value.

Due to use of high power COB's with this product, special attention to proper thermal design is highly recommended. LEDiL has no liability for direct, indirect or consecutive damages arising from the LEDiL products being used outside of the recommended temperature range.

MATERIALS:

As part of our continuous research and improvement processes, and to ensure the best possible quality and availability of our products, LEDiL reserves the right to change material grades without notice.

PRODUCT DATA USER AGREEMENT AND DISCLAIMER:

The measured data in the provided downloadable LEDiL Product Datasheets and Mechanical 2D-Drawings is rounded and provided as reference for planning. LEDiL Oy's optical specifications have been verified by conducting performance testing of the products in accordance with the company's quality system. The reported data are averaged results of multiple measurements with typical variation. LEDiL Oy reserves the right to without prior notification make changes and improvements to its products.

LEDiL Oy assumes neither warranty, nor guarantee nor any other liability of any kind for the contents and correctness of the provided data. The provided data has been generated with highest diligence but the provided data may in reality not represent the complete possible variation range of all intrinsic parameters. Therefore, in certain cases a deviation from the provided data could occur.

LEDiL Oy reserves the right to undertake technical changes of its products without further notification which could lead to changes in the provided data. LEDiL Oy assumes no liability of any kind for the possible deviation from any provided data or any other damage resulting from the usage of the provided data.

The user agrees to this disclaimer and user agreement with the download or usage of the provided files.

LEDiL Oy

Joensuunkatu 13
FI-24240 SALO
Finland

LEDiL Inc.

228 West Page Street
Suite D
Sycamore IL 60178
USA

Ledil Optics Technology (Shenzhen) Co., Ltd.

405 , Block B
Casic Motor Building
Shenzhen 518057
P.R.CHINA

Local sales and technical support

[www.ledil.com/
where_to_buy](http://www.ledil.com/where_to_buy)

Shipping locations

Salo, Finland
Hong Kong, China

Distribution Partners

[www.ledil.com/
where_to_buy](http://www.ledil.com/where_to_buy)