

P1: M-042

P2: M-048A

Customer No.: No.:1

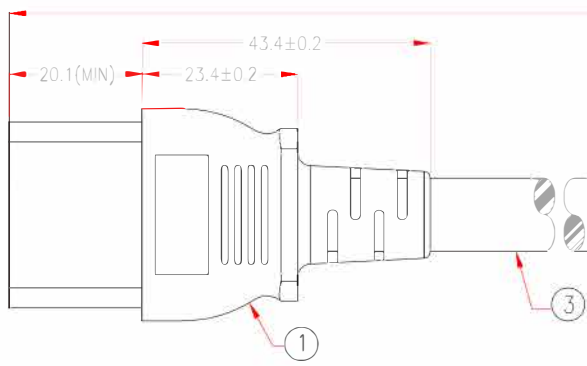
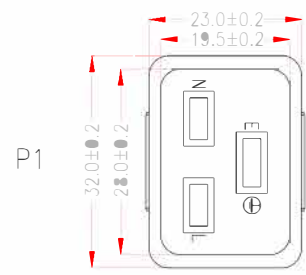

IEC 60320 C19(MSL-119)

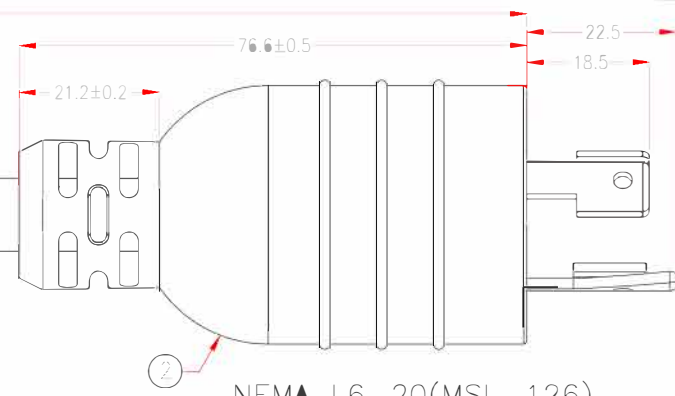

NEMA L6-20(MSL-126)

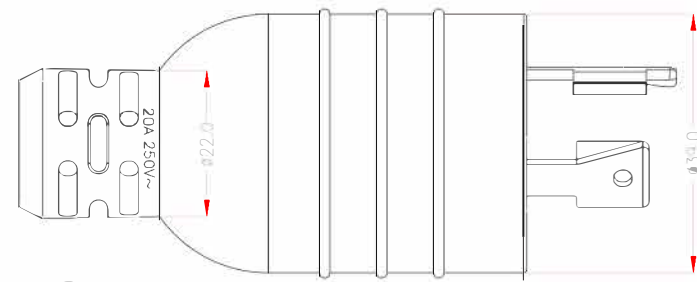
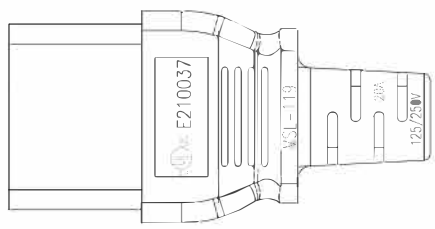
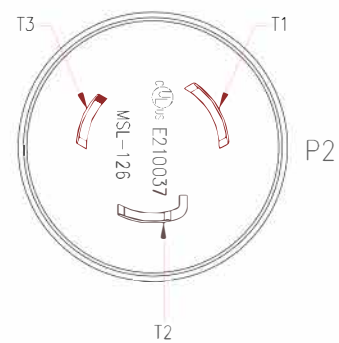

PACKING A: ≥1FT

PACKING B: ≥2FT

PACKING C: <2FT

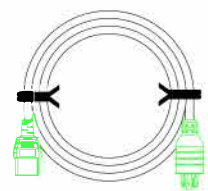
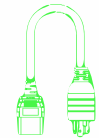
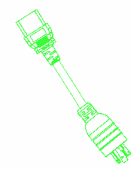

MARKING: (UL) SJT 3/C 12AWG(3.31MM²) VW-1 105°C 300V E204978

CSA SJT 3/C 3.31MM²(12AWG) FT2 105°C 300V 204790 MSL

	P1		P2
BLACK	L	_____	T1
WHITE	N	_____	T3
GREEN	E	_____	T2

P1, P2: E210037

NOTE: All relevant materials are complied with RoHS directive . THE MARKING IS PROTRUDING LETTERING MOULD

3	UL SJT 12AWG x 3C, OD 11.0mm, JACKET BLACK, DRAWING No.EPSJT011203C-158	H5TC41-0304K09	L-20mm	M304
2	MOLDED PVC 35P, COLOR BLACK	H1BC02-0304		M304
	BRACKET: YS-L6	A1QC58-0767	1Set	M767
	TERMINAL: 97656BL-0 (T3)	A1QB39-0257	1	M257
	TERMINAL: 97655BL-0 (T2)	A1QB41-0257	1	M257
1	TERMINAL: 97654BL-0 (T1)	A1QB40-0257	1	M257
	MOLDED PVC 35P, COLOR BLACK	H1BC02-0304	1	M304
	BRACKET: YST-037	A1QC36-0767	1Set	M767
	TERMINAL: 98739ABS-0	A1QB33-0257	3	M257
No.	DESCRIPTION			Q'TY
				Supplier

APPROVED					Unless Otherwise SPEC. Tolerances: 0. ±0.5 .0 ±0.3 .00 ±0.1
CHECKED	HU	15/AUG/17	DRAWN NAME	POWER SUPPLY CORDS & CORDS SETS	
DRAWING	ZHU	15/AUG/17	PRODUCT NO.	PWCD-L620PC19-20A-XXF-BLK	
					UNIT: mm

REV.1 2017.08.15 MODIFY CABLE

NOTE: Cable Length Unless Otherwise Spec. Tolerances: Under 6FT ±25mm; Another ±50mm