

TPSM84A21 and TPSM84A22 Power Module Evaluation Module User's Guide



ABSTRACT

This user's guide contains information for the TPSM84A21EVM-808 and TPSM84A22EVM-809 evaluation modules (PWR808 and PWR809). This user's guide also includes the performance specifications, schematic, bill of materials, and layout of the EVMs.

Table of Contents

1 Description.....	2
2 Getting Started.....	2
3 Test Point Descriptions.....	4
4 Operation Notes.....	5
5 Performance Data.....	6
6 Schematic.....	7
7 Bill of Material.....	8
8 PCB Layout.....	9
9 Revision History.....	11

List of Figures

Figure 2-1. EVM User Interface.....	2
Figure 5-1. TPSM84A22EVM Efficiency (VG = OPEN).....	6
Figure 5-2. TPSM84A22EVM Efficiency (VG = 5 V).....	6
Figure 5-3. TPSM84A22EVM Power Dissipation.....	6
Figure 5-4. TPSM84A22EVM Output Voltage Ripple.....	6
Figure 5-5. Output Current Transient Waveforms.....	6
Figure 5-6. Output Current Transient Waveforms.....	6
Figure 6-1. TPSM84A21EVM Schematic.....	7
Figure 8-1. Topside Component Layout.....	9
Figure 8-2. Bottom-Side Component Layout.....	9
Figure 8-3. Top Copper.....	10
Figure 8-4. Layer 2 Copper.....	10
Figure 8-5. Layer 3 Copper.....	11
Figure 8-6. Bottom Copper.....	11

List of Tables

Table 1-1. Output Voltage Range.....	2
Table 3-1. Test Point Descriptions.....	4
Table 7-1. Bill of Material.....	8

Trademarks

All trademarks are the property of their respective owners.

1 Description

The TPSM84A21 and TPSM84A22 are synchronous buck power modules designed to provide up to 10 A of output current. The TPSM84A21 and TPSM84A22 power modules combine the [TPS54A20](#), a 10-A DC/DC synchronous series capacitor buck converter with power MOSFETs, shielded inductors, input and output capacitors, and passive components into a low-profile package. The input voltage range of both devices is 8 V to 14 V. See the *Minimum Input Voltage* curve in the [TPSM84A22, 8-V to 14-V Input, 1.2-V to 2.05-V Output, 10-A SWIFT Power Module Data Sheet](#) for the minimum required input voltage for $V_{OUT} > 1.5$ V. The output voltage ranges of both devices are given in [Table 1-1](#). The output voltage of the EVM can be set to one of five popular values by using a configuration jumper.

This evaluation module is designed to demonstrate the ease-of-use and small printed-circuit board (PCB) area possible when designing with the TPSM84A21 and TPSM84A22 power modules. Monitoring test points are provided to allow measurement of the following:

- Efficiency
- Power dissipation
- Input ripple
- Output ripple
- Line and load regulation
- Transient response

Additionally, control test points are provided for use of the power good, inhibit control, and undervoltage lockout features of the device. The EVM uses a recommended PCB layout that maximizes thermal performance and minimizes output ripple and noise.

Table 1-1. Output Voltage Range

EVM	Output Voltage Range
TPSM84A21EVM-808	0.55 V to 1.3 V
TPSM84A22EVM-809	1.2 V to 2.05 V

2 Getting Started

[Figure 2-1](#) highlights the user interface items associated with the EVM. The polarized VIN power terminal block (TB1) is used for connection to the host input supply and the polarized VOUT power terminal block (TB2) is used for connection to the load. These terminal blocks can accept up to 16-AWG wire.

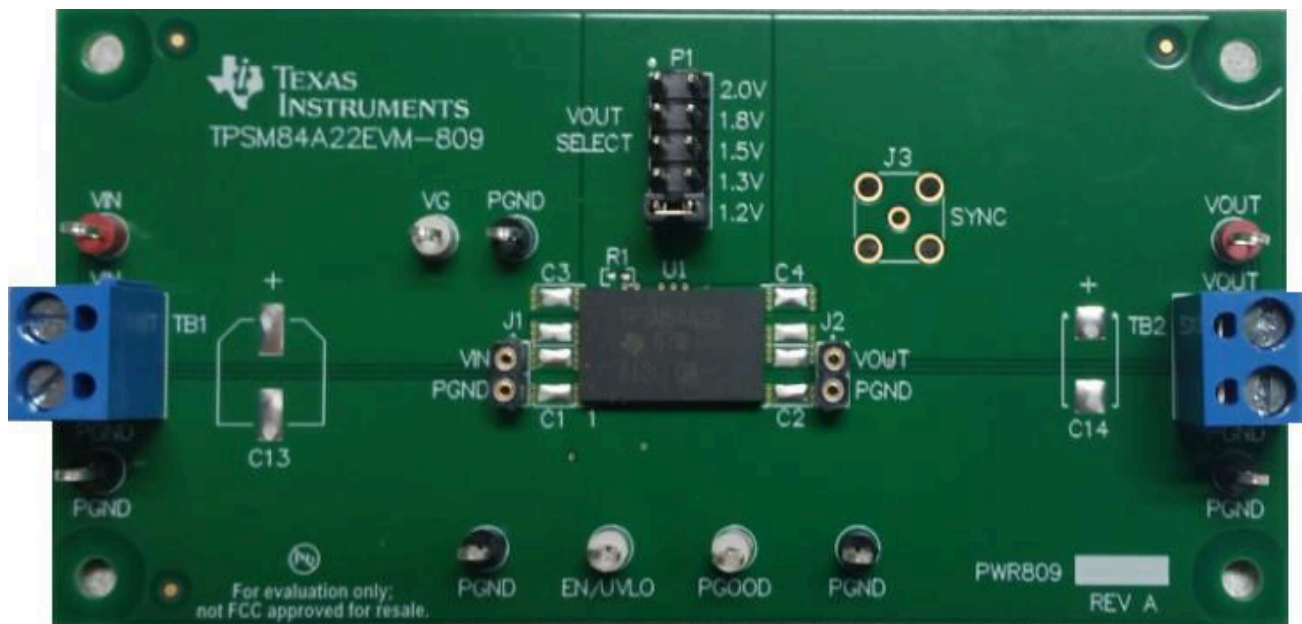

Figure 2-1. EVM User Interface

The VIN monitor and VOUT monitor test points located near the power terminal blocks are intended to be used as voltage monitoring points where voltmeters can be connected to measure VIN and VOUT. The voltmeter references should be connected to the PGND test points located beneath the power terminal blocks. Do not use these VIN and VOUT monitoring test points as the input supply or output load connection points. The PCB traces connecting to these test points are not designed to support high currents.

The VIN scope (J1) and VOUT scope (J2) test points can be used to monitor VIN and VOUT waveforms with an oscilloscope. These test points are intended for use with un-hooded scope probes outfitted with a low-inductance ground lead (ground spring) mounted to the scope barrel. The two sockets of each test point are on 0.1-inch centers. The scope probe tip should be connected to the socket labeled VIN or VOUT, and the scope ground lead should be connected to the socket labeled PGND.

The test points located directly below the device are made available to test the features of the device. Any external connections made to these test points should be referenced to one of the PGND test points located along the bottom of the EVM. Refer to [Section 3](#) for more information on the individual control test points.

The VOUT SELECT jumper (P1) is provided for selecting the desired output voltage. Before applying power to the EVM, ensure that the jumper is present and properly positioned for the intended output voltage.

3 Test Point Descriptions

Wire-loop test points and scope probe test points are provided as convenient connection points for digital voltmeters (DVM) or oscilloscope probes to aid in the evaluation of the device. A BNC connector footprint (J3) is available if a synchronization clock is required. [Table 3-1](#) lists a description of each test point.

Table 3-1. Test Point Descriptions

Pin	Description
VIN	Input voltage monitor. Connect DVM to this point for measuring efficiency.
VOUT	Output voltage monitor. Connect DVM to this point for measuring efficiency, line regulation, and load regulation.
PGND	Input and output voltage monitor grounds. Reference the previously mentioned DVMs to any of these four analog ground points.
VIN Scope (J1)	Input voltage scope monitor. Connect an oscilloscope to this set of points to measure input ripple voltage.
VOUT Scope (J2)	Output voltage scope monitor. Connect an oscilloscope to this set of points to measure output ripple voltage and transient response.
EN/UVLO	Connect this point to control ground to disable the device. Allow this point to float to enable the device. An external resistor divider can be connected between this point, control ground, and VIN to adjust the undervoltage lockout of the device.
PGOOD	Monitors the power good signal of the device. This is an open-drain signal that requires an external pullup resistor if monitoring is desired. A 10- to 100-k Ω pullup resistor is recommended. PWRGD is high if the output voltage is within 95% to 105% of its nominal value.
SYNC (J3)	Connects to the RT/CLK pin of the device. An external clock signal can be applied to this point to synchronize the device to an appropriate frequency.
VG	Gate driver supply pin. If supplying an external 5-V supply, connect to this test point.

Note

Refer to the appropriate product data sheet for absolute maximum ratings associated with the previously-listed features:

- [TPSM84A21, 8V to 14V Input, 0.55V to 1.35V Output, 10-A SWIFT Power Module](#) data sheet
- [TPSM84A22, 8V to 14V Input, 1.2V to 2.05V Output, 10-A SWIFT Power Module](#) data sheet

4 Operation Notes

In order to operate the EVM, the input voltage must increase above the UVLO threshold of the device. The UVLO threshold of the EVM is approximately 7.65 V with 200 mV of hysteresis. To adjust the UVLO threshold to a higher voltage, the values of R8 and R9 on the EVM can be adjusted as described in the product data sheet. The maximum operating input voltage for the device is 14 V. Refer to the product data sheet for further information on the input voltage range and UVLO operation.

The minimum input voltage for the TPSM84A22 is 8 V or $(V_{OUT} \times 5.3)$, whichever is greater.

The soft-start time is a fixed value and cannot be adjusted. After application of the proper input voltage, the output voltage of the device will ramp to its final value in approximately 4.1 ms.

The power-good (PGOOD) indicator of the EVM will assert high when the output voltage is within $\pm 5\%$ of the programmed output voltage value. A 100-k Ω pullup resistor (R11) is populated between the PGOOD pin and the VG pin. The voltage on the VG pin is 4.8 V (typical). The VG and corresponding PGND test points are not loaded on the EVM. If driving the VG pin is required, test points can be added to the EVM.

The current limit of the device can be set to 11.25 A (typical) by placing a 47-k Ω resistor between ILIM and PGND. The EVM has a footprint for this resistor, R10, if needed.

The TPSM84A21 and TPSM84A22 nominal switching frequency is 4 MHz with a range of 3.7 MHz to 4.3 MHz when free-running. If an exact switching frequency is required, both devices can be synchronized to an external clock over the frequency range of 3.6 MHz to 4.4 MHz. Refer to the product data sheet for further information on synchronization.

The TPSM84A21 and TPSM84A22 both include input and output capacitors internal to the device. For most applications, no additional output capacitors are required. The EVM includes footprints for adding input and output capacitors to the EVM. Adding additional capacitance will improve transient response. The actual capacitance required will depend on the input and output voltage conditions of the particular application, along with the desired transient response. Refer to the product data sheet for further information on input and output capacitance and transient response.

5 Performance Data

The graphs and waveforms in [Figure 5-1](#) to [Figure 5-6](#) demonstrate the performance of the TPSM84A22EVM.

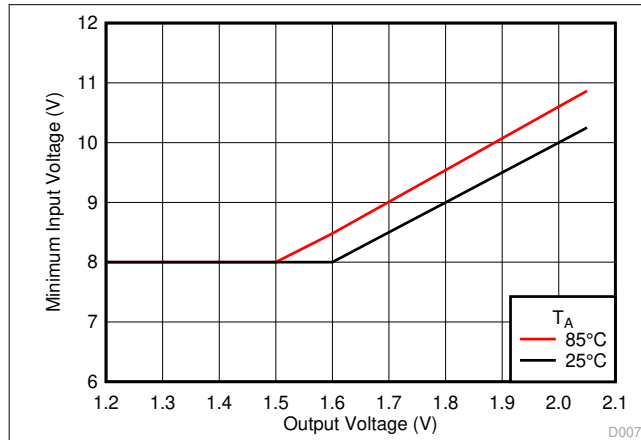

Figure 5-1. TPSM84A22EVM Efficiency (VG = OPEN)

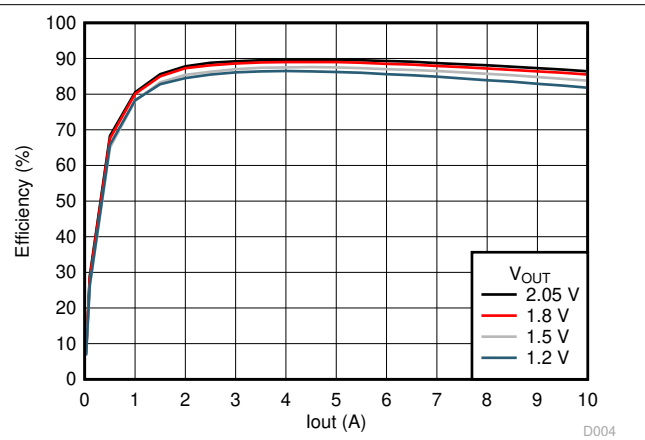

Figure 5-2. TPSM84A22EVM Efficiency (VG = 5 V)

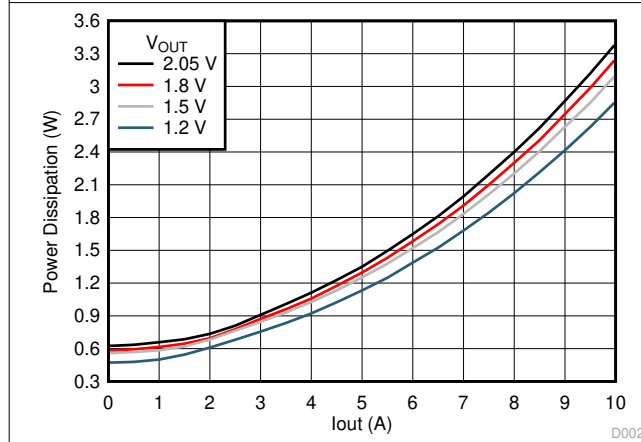

Figure 5-3. TPSM84A22EVM Power Dissipation

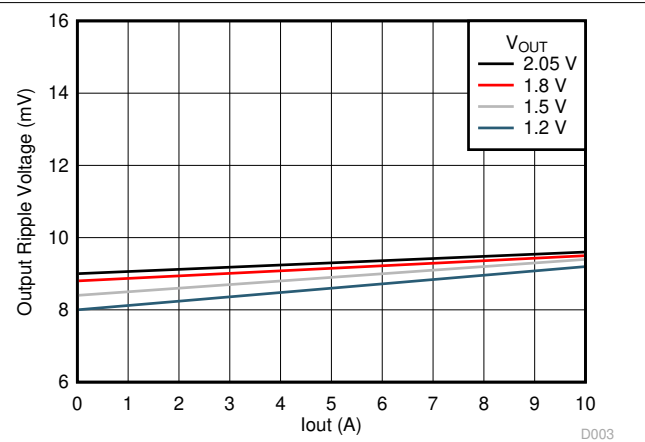

Figure 5-4. TPSM84A22EVM Output Voltage Ripple

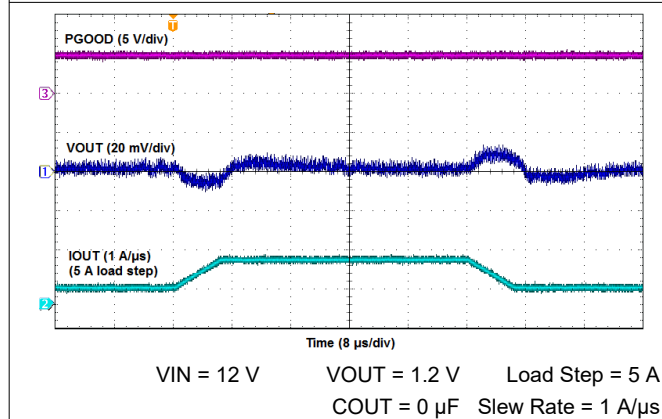

Figure 5-5. Output Current Transient Waveforms

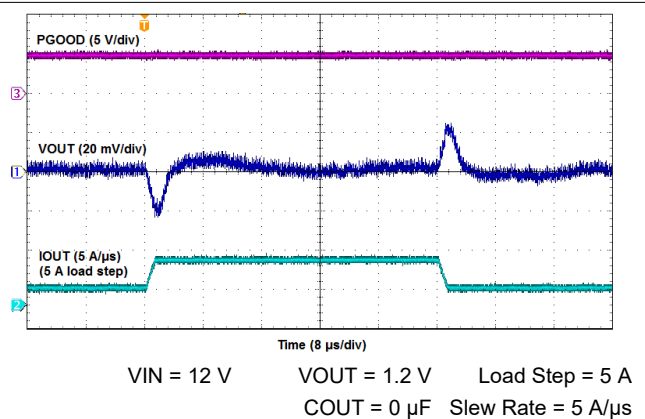

Figure 5-6. Output Current Transient Waveforms

7 Bill of Material

Table 7-1 lists the EVM bill of materials.

Table 7-1. Bill of Material

DESIGNATOR	QUANTITY		DESCRIPTION	PART NUMBER	MANUFACTURER
	PWR808	PWR809			
PCB	1	1	Printed Circuit Board	PWR808	Any
U1	1	0	TPSM84A21, 10-A, SWIFT Power Module	TPSM84A21MOJ	Texas Instruments
	0	1	TPSM84A22, 10-A, SWIFT Power Module	TPSM84A22MOJ	Texas Instruments
C1, C3, C5, C7, C9, C11	0	0	CAP, CERM, 22 μ F, 25 V, \pm 10%, X5R, 1210	GRM32ER61E226KE15L	MuRata
C2, C4, C6, C8, C10, C12	0	0	CAP, CERM, 47 μ F, 10 V, \pm 10%, X5R, 1210	GRM32ER61A476KE20L	MuRata
C13	0	0	CAP, Aluminum Polymer, 100 μ F, 25 V, \pm 20%, 0.024 Ω , 8.0 \times 7.0 mm SMD	25SVPF100M	Panasonic
C14	0	0	CAP, Tantalum Polymer, 220 μ F, 10 V, \pm 20%, 0.025 Ω , 7343-30 SMD	10TPE220ML	Panasonic
J1, J2	2	2	Socket Strip, 2 \times 1, 100 mil, Black, Tin, TH	310-43-102-41-001000	Mill-Max
J3	0	0	Connector, SMB, Vertical RCP 0-4GHz, 50 Ω , TH	131-3701-261	Emerson Network Power
P1	1	1	Header, 100mil, 5 \times 2, Tin, TH	PEC05DAAN	Sullins Connector Solutions
R1	0	0	RES, 732, 1%, 0.063 W, 0402	CRCW0402732RFKED	Vishay-Dale
R2	1	0	RES, 5.49 k, 1%, 0.1 W, 0603	CRCW06035K49FKEA	Vishay-Dale
	0	1	RES, 732, 1%, 0.1 W, 0603	CRCW0603732RFKEA	Vishay-Dale
R3	1	0	RES, 1.74 k, 1%, 0.1 W, 0603	CRCW06031K74FKEA	Vishay-Dale
	0	1	RES, 649, 1%, 0.1 W, 0603	CRCW0603649RFKEA	Vishay-Dale
R4	1	0	RES, 1.02 k, 1%, 0.1 W, 0603	CRCW06031K02FKEA	Vishay-Dale
	0	1	RES, 511, 1%, 0.1 W, 0603	CRCW0603511RFKEA	Vishay-Dale
R5	1	0	RES, 866, 1%, 0.1 W, 0603	CRCW0603866RFKEA	Vishay-Dale
	0	1	RES, 392, 1%, 0.1 W, 0603	CRCW0603392RFKEA	Vishay-Dale
R6	1	0	RES, 732, 1%, 0.1 W, 0603	CRCW0603732RFKEA	Vishay-Dale
	0	1	RES, 340, 1%, 0.1 W, 0603	CRCW0603340RFKEA	Vishay-Dale
R7	1	1	RES, 0, 5%, 0.1 W, 0603	CRCW0603000Z0EA	Vishay-Dale
R8	1	1	RES, 60.4 k, 1%, 0.1 W, 0603	CRCW060360K4FKEA	Vishay-Dale
R9	1	1	RES, 12.4 k, 1%, 0.1 W, 0603	CRCW060312K4FKEA	Vishay-Dale
R10	0	0	RES, 47 k, 5%, 0.1 W, 0603	CRCW060347K0JNEA	Vishay-Dale
R11	1	1	RES, 100 k, 5%, 0.063 W, 0402	CRCW0402100KJNED	Vishay-Dale
R12	0	0	RES, 49.9, 1%, 0.75 W, AEC-Q200 Grade 0, 2010	CRCW201049R9FKEF	Vishay-Dale
SH-P1	1	1	Shunt, 2mm, Gold plated, Black	2SN-BK-G	Samtec
TB1, TB2	2	2	Terminal Block, 5.08 mm, 2 \times 1, Brass, TH	ED120/2DS	On-Shore Technology
TP1, TP2	2	2	Test Point, Multipurpose, Red, TH	5010	Keystone
TP3, TP4, TP6, TP7, TP11	5	5	Test Point, Multipurpose, Black, TH	5011	Keystone
TP8, TP9, TP10	3	3	Test Point, Multipurpose, White, TH	5012	Keystone

8 PCB Layout

Figure 8-1 through Figure 8-6 display the EVM PCB layouts.

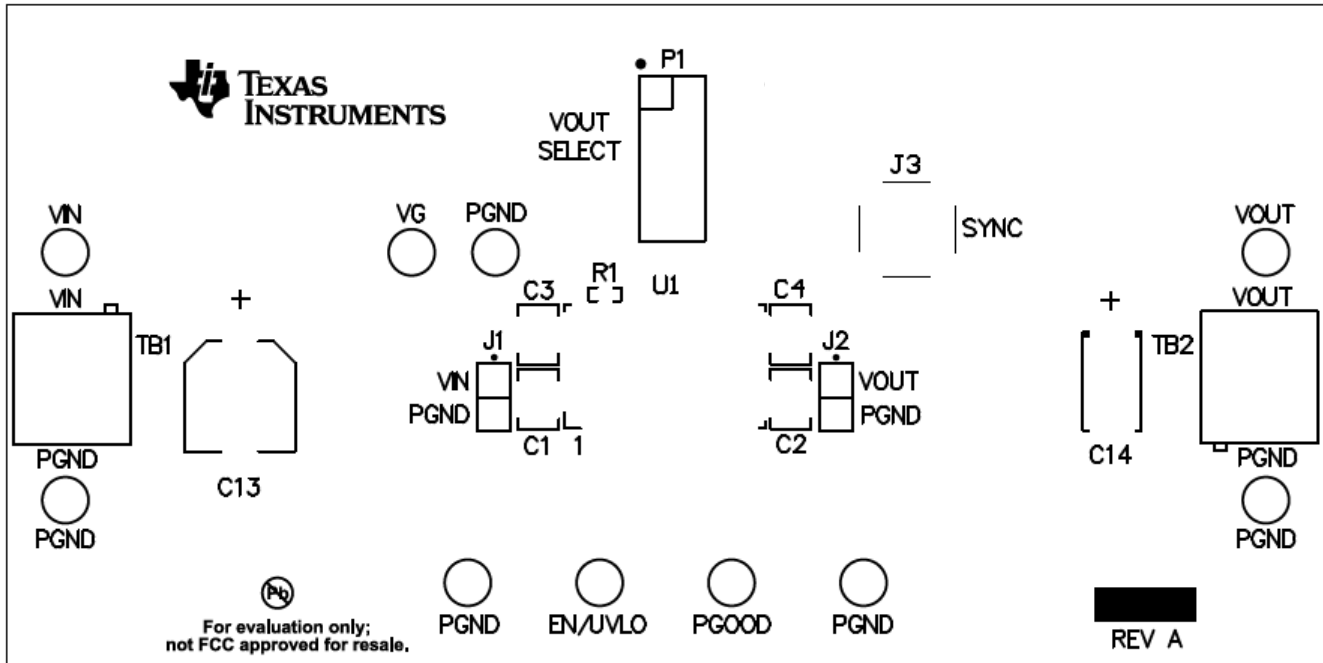

Figure 8-1. Topside Component Layout

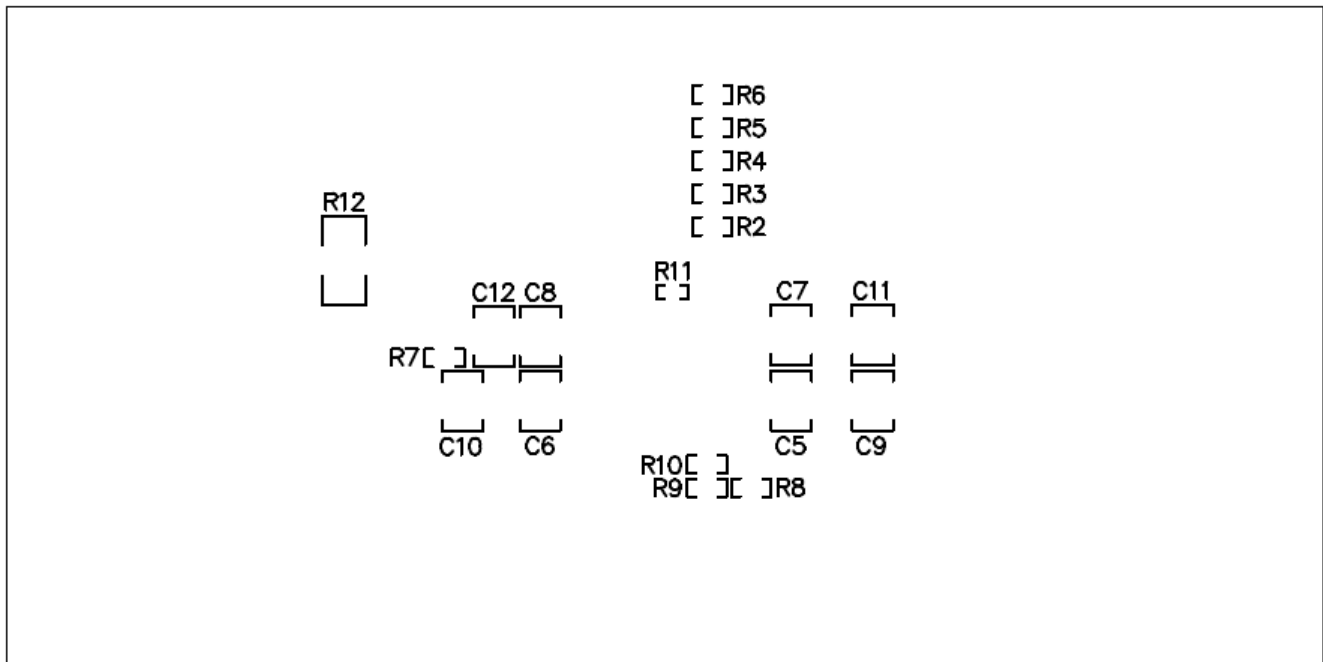

Figure 8-2. Bottom-Side Component Layout

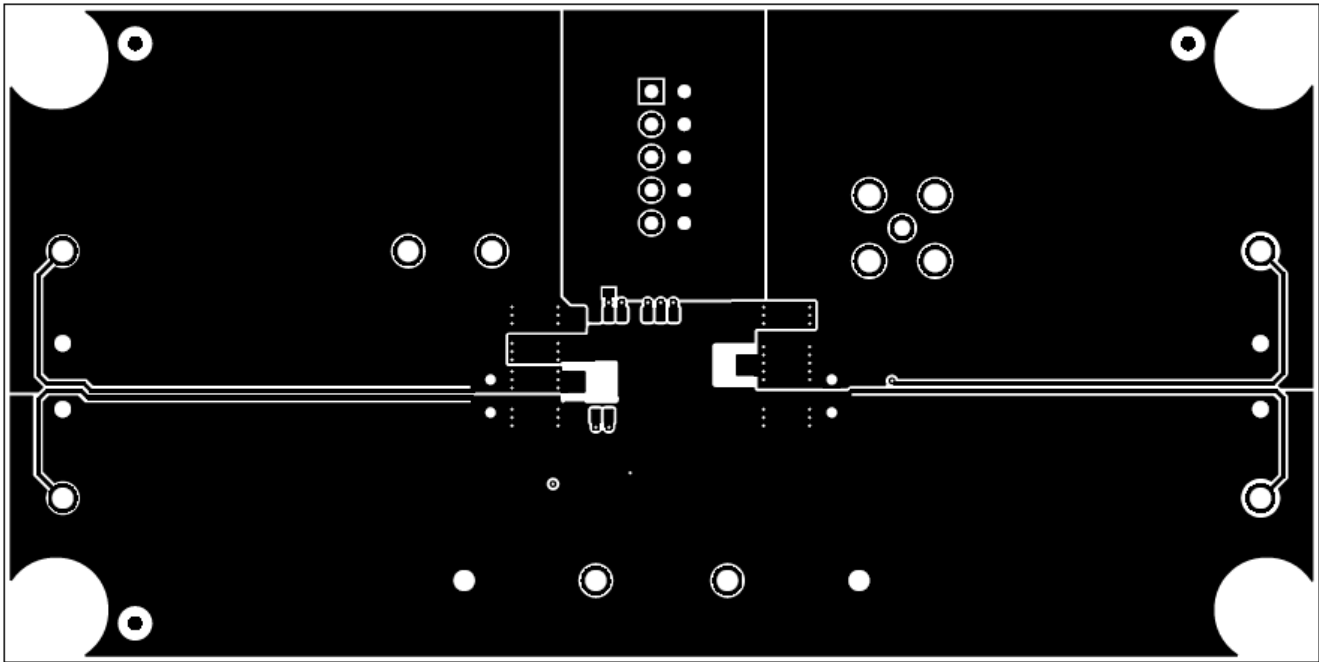

Figure 8-3. Top Copper

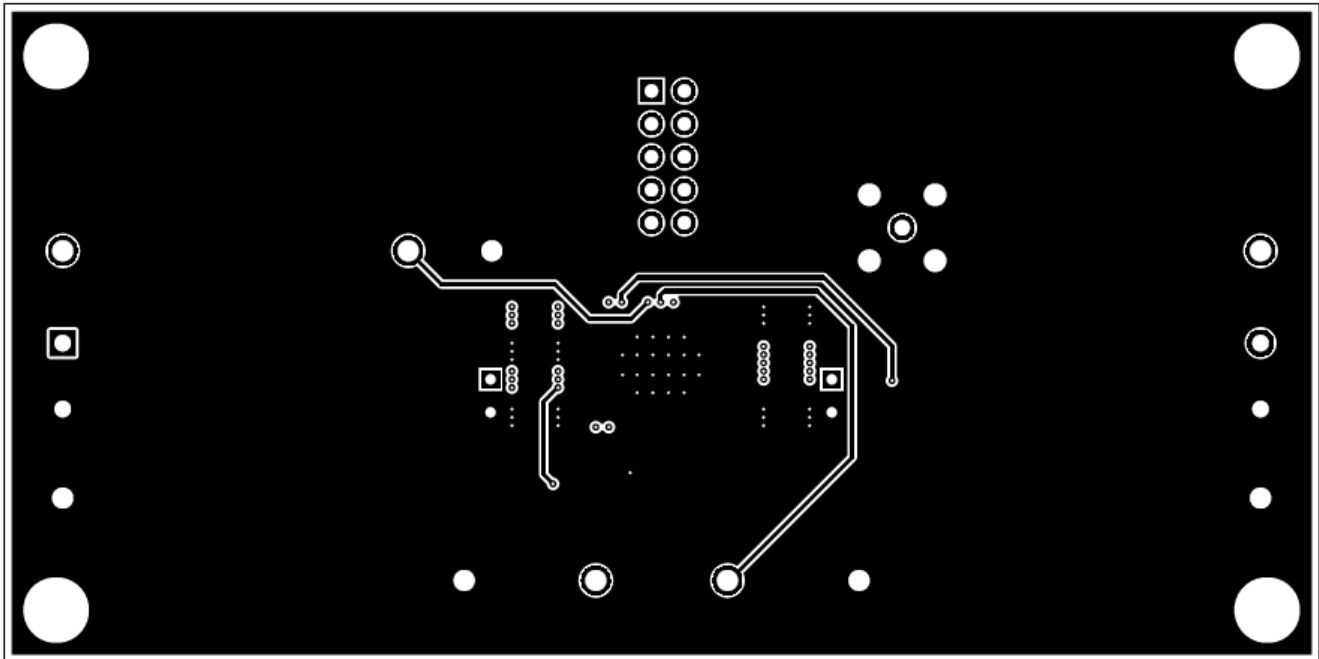

Figure 8-4. Layer 2 Copper

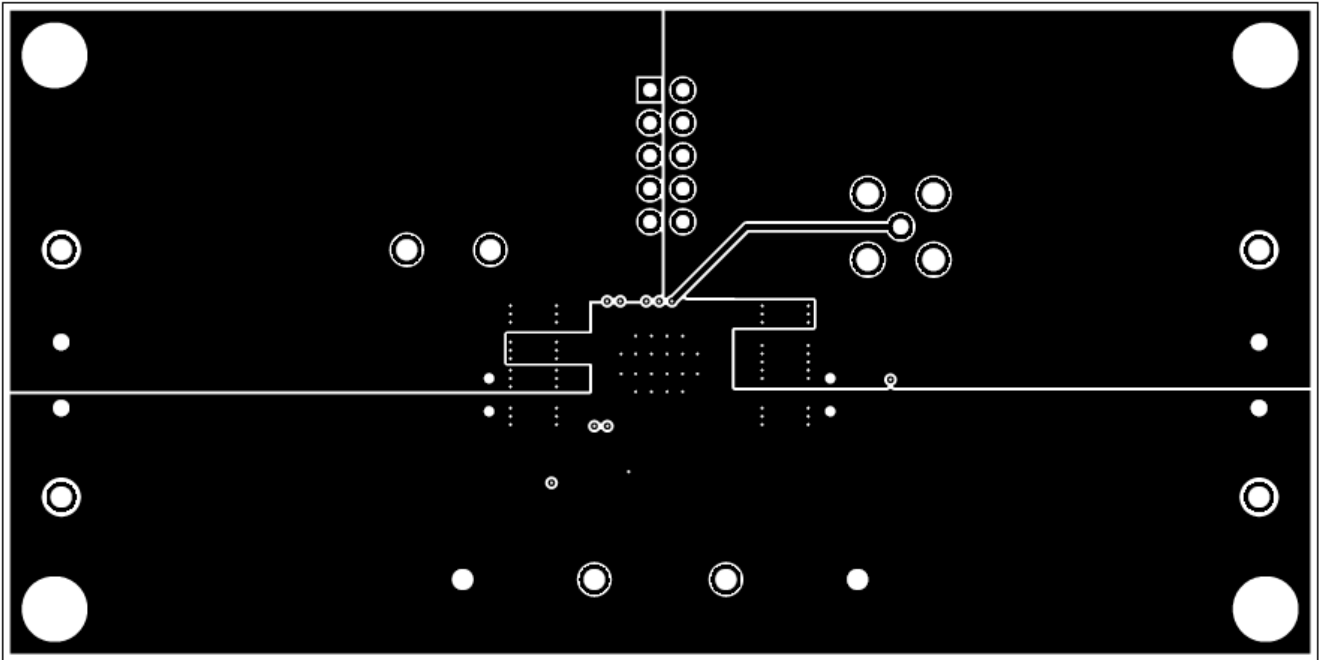

Figure 8-5. Layer 3 Copper

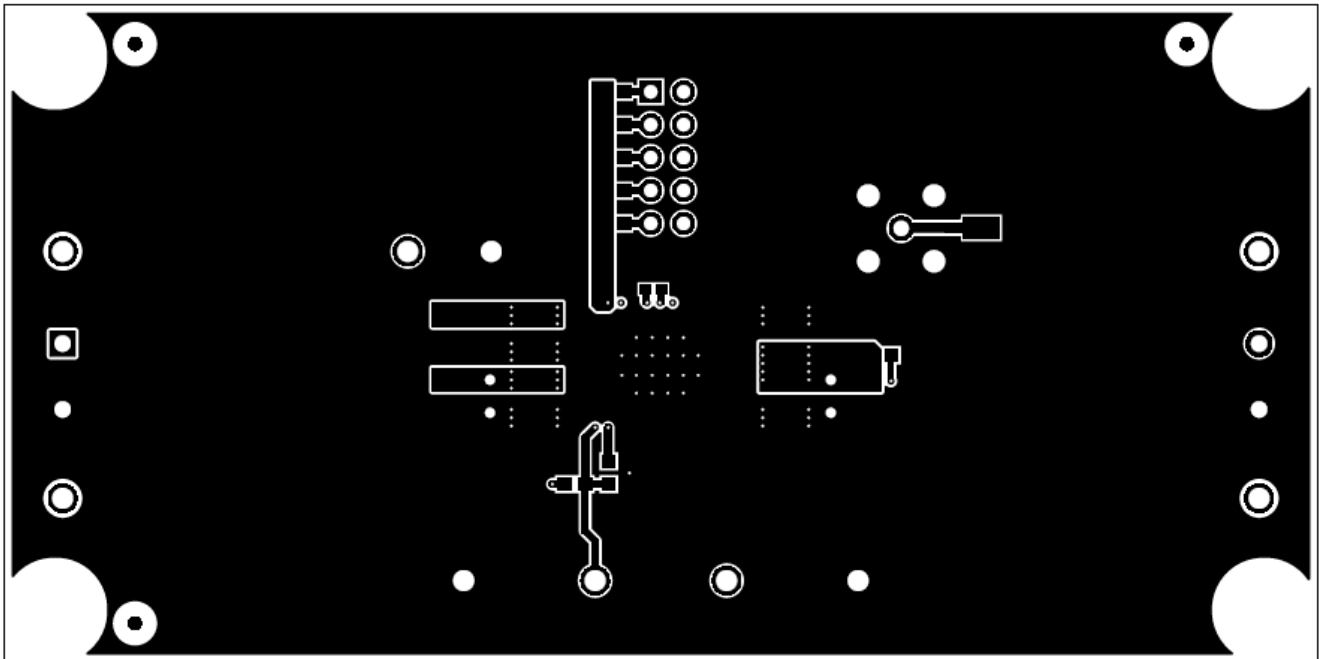

Figure 8-6. Bottom Copper

9 Revision History

NOTE: Page numbers for previous revisions may differ from page numbers in the current version.

Changes from Revision * (November 2016) to Revision A (February 2022)	Page
• Updated the numbering format for tables, figures, and cross-references throughout the document.	2
• Updated the user's guide title.....	2

IMPORTANT NOTICE AND DISCLAIMER

TI PROVIDES TECHNICAL AND RELIABILITY DATA (INCLUDING DATA SHEETS), DESIGN RESOURCES (INCLUDING REFERENCE DESIGNS), APPLICATION OR OTHER DESIGN ADVICE, WEB TOOLS, SAFETY INFORMATION, AND OTHER RESOURCES "AS IS" AND WITH ALL FAULTS, AND DISCLAIMS ALL WARRANTIES, EXPRESS AND IMPLIED, INCLUDING WITHOUT LIMITATION ANY IMPLIED WARRANTIES OF MERCHANTABILITY, FITNESS FOR A PARTICULAR PURPOSE OR NON-INFRINGEMENT OF THIRD PARTY INTELLECTUAL PROPERTY RIGHTS.

These resources are intended for skilled developers designing with TI products. You are solely responsible for (1) selecting the appropriate TI products for your application, (2) designing, validating and testing your application, and (3) ensuring your application meets applicable standards, and any other safety, security, regulatory or other requirements.

These resources are subject to change without notice. TI grants you permission to use these resources only for development of an application that uses the TI products described in the resource. Other reproduction and display of these resources is prohibited. No license is granted to any other TI intellectual property right or to any third party intellectual property right. TI disclaims responsibility for, and you will fully indemnify TI and its representatives against, any claims, damages, costs, losses, and liabilities arising out of your use of these resources.

TI's products are provided subject to [TI's Terms of Sale](#) or other applicable terms available either on ti.com or provided in conjunction with such TI products. TI's provision of these resources does not expand or otherwise alter TI's applicable warranties or warranty disclaimers for TI products.

TI objects to and rejects any additional or different terms you may have proposed.

Mailing Address: Texas Instruments, Post Office Box 655303, Dallas, Texas 75265
Copyright © 2022, Texas Instruments Incorporated