

DT04-6P-L012 ✓ ACTIVE

DEUTSCH | DEUTSCH DT

TE Internal #: DT04-6P-L012

Housing for Male Terminals, Wire-to-Wire, 6 Position, .359 in [9.12 mm] Centerline, Sealable, Gray, Wire & Cable, Power & Signal, DEUTSCH DT

[View on TE.com >](#)



Connectors > Automotive Connectors > Automotive Housings > DEUTSCH DT Receptacle Connectors

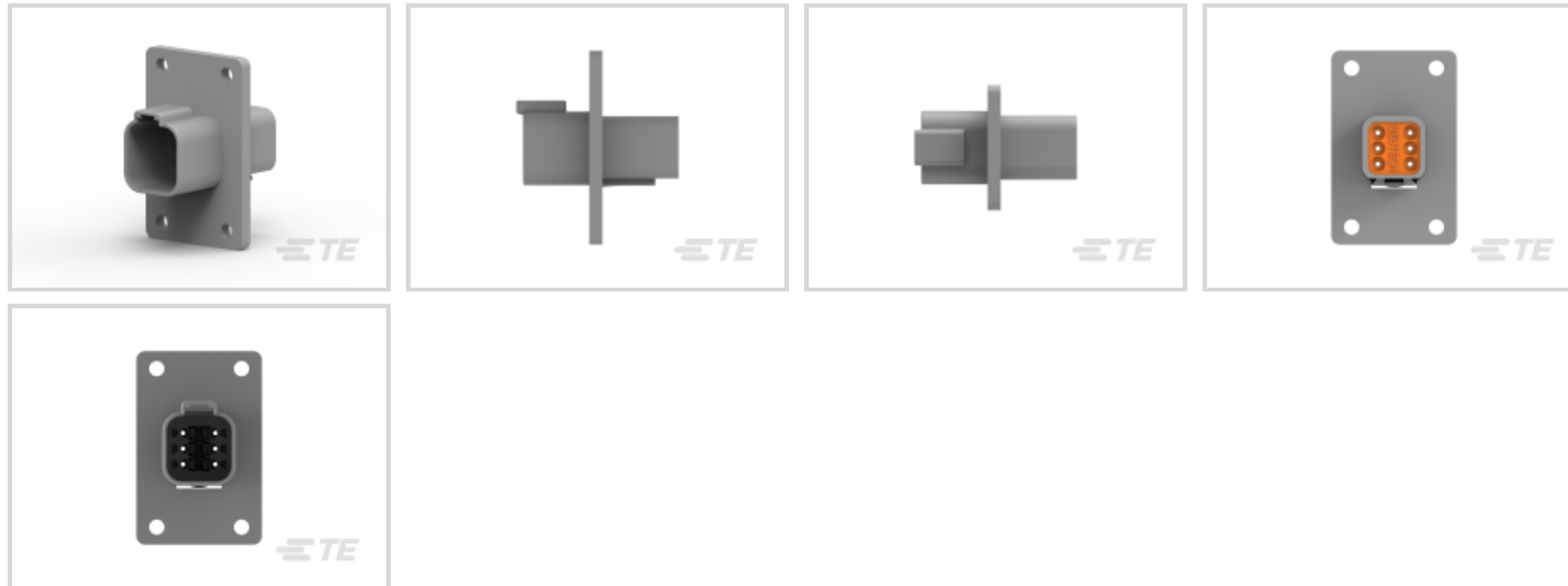

Connector & Housing Type: **Housing for Male Terminals**

Mating Pin Diameter: **1.59 mm [.063 in]**

Connector System: **Wire-to-Wire**

Number of Positions: **6**

Centerline (Pitch): **9.12 mm [.359 in]**

[All DEUTSCH DT Receptacle Connectors \(241\)](#)

Features

Product Type Features

Connector Shape	Rectangular
Connector & Housing Type	Housing for Male Terminals
Connector System	Wire-to-Wire
Sealable	Yes
Hybrid Connector	No
Primary Locking Feature	Integrated in Housing
Connector & Contact Terminates To	Wire & Cable

Configuration Features

Blank Cavity Position	0
Number of Positions	6
Number of Rows	3

Electrical Characteristics



Operating Voltage	250 VAC
-------------------	---------

Nominal Voltage Architecture	12 V, 24 V, 48 V
------------------------------	------------------

Body Features

Cable Exit Angle	180°
------------------	------

Primary Product Color	Gray
-----------------------	------

Contact Features

Contact Size	Size 16
--------------	---------

Contact Type	Pin
--------------	-----

Mating Pin Diameter	1.59 mm [.063 in]
---------------------	-------------------

Contact Current Rating (Max)	13 A
------------------------------	------

Mechanical Attachment

Terminal Position Assurance	Yes
-----------------------------	-----

Strain Relief	Add By Accessory
---------------	------------------

Mating Alignment Type	Polarized
-----------------------	-----------

Mating Alignment	With
------------------	------

Connector Mounting Type	Panel Mount
-------------------------	-------------

Housing Features

Housing Material	PA GF
------------------	-------

Centerline (Pitch)	9.12 mm [.359 in]
--------------------	-------------------

Dimensions

Connector Height	54.99 mm [2.165 in]
------------------	---------------------

Product Width	35.51 mm [1.398 in]
---------------	---------------------

Product Length	45.92 mm [1.808 in]
----------------	---------------------

Row-to-Row Spacing	4.45 mm [.175 in]
--------------------	-------------------

Accepts Insulation Diameter Range	2.23 – 3.68 mm [.088 – .145 in]
-----------------------------------	---------------------------------

Usage Conditions

Operating Temperature (Max)	125 °C [257 °F]
-----------------------------	-----------------

Operating Temperature Range	-55 – 125 °C [-67 – 257 °F]
-----------------------------	-----------------------------

Operation/Application

Circuit Application	Power & Signal
---------------------	----------------

Industry Standards

Degree of Protection	IP68, IP6K9K
----------------------	--------------



Agency/Standard	SAE J2030
UL Flammability Rating	12mm Flame Test per Standard UL-94

Packaging Features

Packaging Quantity	400
Packaging Method	Box

Other

Serviceable	Yes
Connector Position Assurance Capable	No

Product Compliance

[For compliance documentation, visit the product page on TE.com>](#)

EU RoHS Directive 2011/65/EU	Compliant
EU ELV Directive 2000/53/EC	Compliant
China RoHS 2 Directive MIIT Order No 32, 2016	No Restricted Materials Above Threshold
EU REACH Regulation (EC) No. 1907/2006	Current ECHA Candidate List: JAN 2023 (233) Candidate List Declared Against: JAN 2023 (233) Does not contain REACH SVHC
Halogen Content	Not Low Halogen - contains Br or Cl > 900 ppm.
Solder Process Capability	Not reviewed for solder process capability

Product Compliance Disclaimer

This information is provided based on reasonable inquiry of our suppliers and represents our current actual knowledge based on the information they provided. This information is subject to change. The part numbers that TE has identified as EU RoHS compliant have a maximum concentration of 0.1% by weight in homogenous materials for lead, hexavalent chromium, mercury, PBB, PBDE, DBP, BBP, DEHP, DIBP, and 0.01% for cadmium, or qualify for an exemption to these limits as defined in the Annexes of Directive 2011/65/EU (RoHS2). Finished electrical and electronic equipment products will be CE marked as required by Directive 2011/65/EU. Components may not be CE marked. Additionally, the part numbers that TE has identified as EU ELV compliant have a maximum concentration of 0.1% by weight in homogenous materials for lead, hexavalent chromium, and mercury, and 0.01% for cadmium, or qualify for an exemption to these limits as defined in the Annexes of Directive 2000/53/EC (ELV). Regarding the REACH Regulation, the information TE provides on SVHC in articles for this part number is based on the latest European Chemicals Agency (ECHA) 'Guidance on requirements for substances in articles' posted at this URL: <https://echa.europa.eu/guidance-documents/guidance-on-reach>

Compatible Parts





TE Part # CAT-J41-DDPC
DEUTSCH DT Plug Connectors



TE Part # CAT-D48-SP729
DEUTSCH Sealing Plugs



TE Part # CAT-D487-B128
DEUTSCH DT Backshells



TE Part # CAT-D48-ST273
DEUTSCH Solid Contacts



TE Part # W6P
WEDGE LOCK, 6P, REC, GRN, DT



TE Part # DT-RT1
EXT TOOL, FRONT RELEASE



TE Part # DT6P-DC
PROTECT CVR, 6P, REC, GRY, DT



TE Part # CAT-J67-DSCC16
DEUTSCH Size 16 Crimp Contacts



TE Part # DT6P-BT
BOOT, 6P, REC, ST, GRY



TE Part # DT6P-BT-BK
BOOT, 6P, REC, ST, BLK



TE Part # 2300908-1
0460-003-16329, PIN, SOLID, 20-24AWG, AU



TE Part # CAT-D48-SFT273
DEUTSCH Stamped and Formed Contacts

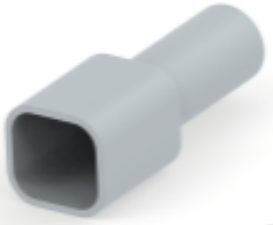

TE Part # DT6P-BT-YW
BOOT, 6P, REC, ST, YEL

Also in the Series | **DEUTSCH DT**



Automotive Connector Caps & Covers
(107)



Automotive Connector Locks & Position Assurance(74)



Automotive Housings(618)



Automotive Seals & Cavity Plugs(5)



Insertion & Extraction Tools(3)



Other Automotive Connector Accessories(16)

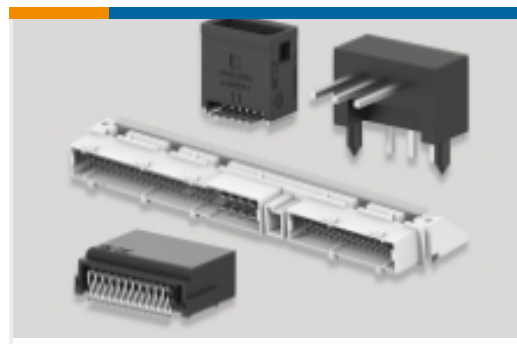

PCB Headers & Receptacles(102)

Customers Also Bought



TE Part #DT04-2P-L012
DEUTSCH DT Receptacle Connectors



TE Part #HDP24-24-21SE-L017
REC, 21P, BLK, E, RNG, 12/16, S



TE Part #W6P
WEDGE LOCK, 6P, REC, GRN, DT



TE Part #2292865-2
AMPSEAL 16 Connectors Backshell



TE Part #TAA755A1611-020
M12A5-MS-FS-PVC-2.0M



TE Part #1SET411015R0000
WD-1-DP-GR4080

Documents

Product Drawings

REC, 6P, GRY, N, FLANGE

English

CAD Files

3D PDF

3D

Customer View Model

[ENG_CVM_CVM_DT04-6P-L012_E.2d_dxf.zip](#)

English

Customer View Model

[ENG_CVM_CVM_DT04-6P-L012_E.3d_igs.zip](#)

English

Customer View Model

[ENG_CVM_CVM_DT04-6P-L012_E.3d_stp.zip](#)

English

By downloading the CAD file I accept and agree to the [Terms and Conditions](#) of use.



Datasheets & Catalog Pages

[ICT Terminals and Connectors Catalogue](#)

English

Product Specifications

[Application Specification](#)

English

Agency Approvals

[UL Report](#)

English