

IEC Appliance Inlet C14, Screw-on Mounting, Front or Rear Side, Solder or Quick-connect Terminal



See below:  
[Approvals and Compliances](#)

**Description**

- Panel mount :  
 Screw-on mounting , front or rear-side
- Appliance Inlet , Pin temperature 70 °C , Protection class I
- Solder or Quick Connect Terminal

**Weblinks**

[pdf data sheet](#), [html datasheet](#), [General Product Information](#), [Distributor-Stock-Check](#), [Accessories](#), [Detailed request for product](#), [Landing Page](#)

Newly available variants corresponding to V-Lock mating cordset. The connector is equipped with a notch intended for use with the latching cordset. The cord latching system prevents against accidental removal of the cordset.

**Technical Data**

Ratings IEC	10A / 250VAC; 50Hz	appliance inlet/-outlet	C14 acc. to IEC 60320-1
Ratings UL/CSA	15A / 250VAC; 60Hz		UL 60320-1, CSA C22.2 no. 60320-1
Dielectric Strength	> 3kVAC between L-N > 1.5kVAC between L/N-PE (1 min/50Hz)		(for cold conditions) pin-temperature 70 °C, 10A, Protection Class I
Allowable Operation Temperature	-25 °C to 70 °C		
IP-Protection	from front side IP20 acc. to IEC 60529		
Insulation cover	Suitable for appliances with protection class I acc. to IEC 61140		
Material: Housing	PA6, black, UL 94V-0		

**Approvals and Compliances**

Detailed information on product approvals, code requirements, usage instructions and detailed test conditions can be looked up in [Details about Approvals](#)

SCHURTER products are designed for use in industrial environments. They have approvals from independent testing bodies according to national and international standards. Products with specific characteristics and requirements such as required in the automotive sector according to IATF 16949, medical technology according to ISO 13485 or in the aerospace industry can be offered exclusively with customer-specific, individual agreements by SCHURTER.

**Approvals**

The approval mark is used by the testing authorities to certify compliance with the safety requirements placed on electronic products.  
 Approval Reference Type: 6048

Approval Logo	Certificates	Certification Body	Description
	<a href="#">VDE Approvals</a>	VDE	Certificate Number: 40011871
	<a href="#">UL Approvals</a>	UL	UL File Number: E96454

## Product standards

Product standards that are referenced

Organization	Design	Standard	Description
	Designed according to	IEC 60320-1	Appliance couplers for household and similar general purposes
	Designed according to	UL 60320-1	Standard for Attachment Plugs and Receptacles
	Designed according to	CSA C22.2 no. 60320-1	General Use Receptacles, Attachment Plugs, and Similar Wiring Devices





## Application standards

Application standards where the product can be used

Organization	Design	Standard	Description
	Designed for applications acc.	IEC/UL 60950	IEC 60950-1 includes the basic requirements for the safety of information technology equipment.

## Compliances

The product complies with following Guide Lines

Identification	Details	Initiator	Description
	<a href="#">CE declaration of conformity</a>	SCHURTER AG	The CE marking declares that the product complies with the applicable requirements laid down in the harmonisation of Community legislation on its affixing in accordance with EU Regulation 765/2008.
	RoHS	SCHURTER AG	Directive RoHS 2011/65/EU, Amendment (EU) 2015/836
	China RoHS	SCHURTER AG	The law SJ / T 11363-2006 (China RoHS) has been in force since 1 March 2007. It is similar to the EU directive RoHS.
	REACH	SCHURTER AG	On 1 June 2007, Regulation (EC) No 1907/2006 on the Registration, Evaluation, Authorization and Restriction of Chemicals 1 (abbreviated as "REACH") entered into force.
		SCHURTER AG	V-Lock system are based on a matching plug-dose combination. The connector is equipped with a notch intended for use with the latching cordset. The cord latching system prevents against accidental removal of the cordset.

## Dimensions [mm]

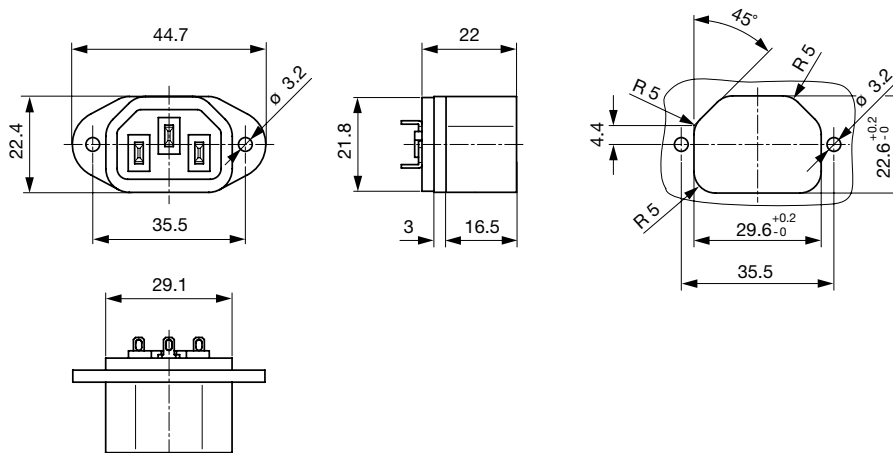

Length of the terminal please find at the order code configuration table

## Config. Code

6048 - H - A B C 0 - D - E O

The characters are placeholders for the correspondingly keys of selections from the key tables.

6048 - **H** - A B C 0 - D - E O = Type





Type

Configuration key

protection class I

X

6048 - H - A B C 0 - D - E O = Terminals

Terminal L		Configuration key
short solder terminal (L = 4.8 mm)		2
long solder terminal (L = 8.5 mm)		3
Blade terminal (4.8 x 0.8 mm)		8
Blade terminal (6.3 x 0.8 mm)		9

6048 - H - A B C 0 - D - E O = Terminals

Terminal N		Configuration key
short solder terminal (L = 4.8 mm)		2
long solder terminal (L = 8.5 mm)		3
Blade terminal (4.8 x 0.8 mm)		8
Blade terminal (6.3 x 0.8 mm)		9

Symbols similar as in table A

6048 - H - A B C 0 - D - E O = Terminals

Terminal Ground	Configuration key
short solder terminal (L = 4.8 mm)	2
long solder terminal (L = 8.5 mm)	3
Blade terminal (4.8 x 0.8 mm)	8
Blade terminal (6.3 x 0.8 mm)	9

Symbols similar as in table A

6048 - H - A B C 0 - D - E O = Color

Color	Configuration key
Black	A

6048 - H - A B C 0 - D - E O = Style

Style	Configuration key
flange with through holes	2

6048 - H - A B C 0 - D - E O = Features

Features	Configuration key
without V-Lock	0
V-Lock	V

All Variants

Terminals L / N	Terminal Ground	Color	Features	Config. Code	Order Number
short solder terminal (L = 4.8 mm)	short solder terminal (L = 4.8 mm)	black	-	6048-X-2220-A-20	6162.0040
Blade terminal (4.8 x 0.8 mm)	Blade terminal (4.8 x 0.8 mm)	black	-	6048-X-8880-A-20	6162.0042
Blade terminal (6.3 x 0.8 mm)	Blade terminal (6.3 x 0.8 mm)	black	-	6048-X-9990-A-20	6162.0043
short solder terminal (L = 4.8 mm)	short solder terminal (L = 4.8 mm)	black	V-Lock	6048-X-2220-A-2V	6162.0174

The listed variants should be available from stock. Other versions on request [www.schurter.com/contact](http://www.schurter.com/contact)

Most Popular.

Availability for all products can be searched real-time: <https://www.schurter.com/en/Stock-Check/Stock-Check-SCHURTER>

Packaging unit 50 Pcs

Mating Outlets/Connectors

Category / Description

[Appliance Outlet Overview complete](#)



4787, Mounting: Screw-on mounting, Appliance Outlet: IEC Solder terminals, 10 A, Suitable for appliances with protection class I	4787
4788, Mounting: Snap-in version, Appliance Outlet: IEC Solder terminals or quick connect terminals, 10 A, Suitable for appliances with protection class I	4788
IEC Appliance Outlet F or H, Screw-on Mounting, Front Side, Solder, PCB or Quick-connect Terminal	5091

[Appliance Outlet further types to 6048](#)

[Connector Overview complete](#)

4022 Mounting: Power Supply Cord, 3 x 1.5 mm <sup>2</sup> , Screw clamps, Connector: IEC C13	<a href="#">4022</a>
4782 Mounting: Power Cord, 3 x 1 mm <sup>2</sup> / 3 x 18 AWG, Cable, Connector: IEC C13	<a href="#">4782</a>
4012 Mounting: Power Supply Cord, 3 x 1 mm <sup>2</sup> , Screw clamps, Connector: IEC C13	<a href="#">4012</a>
4785 Mounting: Power Cord, 3 x 1 mm <sup>2</sup> / 3 x 18 AWG, Cable, Connector: IEC C13	<a href="#">4785</a>
4300-06 Mounting: Power Cord, 3 x 1 mm <sup>2</sup> / 3 x 18 AWG, Cable, Connector: IEC C13	<a href="#">4300-06</a>
<a href="#">Connector further types to 6048</a>	...

## Mating Outlets/Connectors shuttered

[Power Cord Overview complete](#)

VAC13KS, Overview, V-Lock cord retaining, diverse Connector IEC C13, diverse, black	<a href="#">VAC13KS</a>
<a href="#">Power Cord further types to 6048</a>	