

Mounting Option

03-.116 (2.95) I.D. Floating Eyelets

Contact Detail

559-90 Degree Bend (Code 541 Contacts)

.100 [2.54] Contact Spacing x .200 [5.08] Row Spacing

THIS IS A C.A.D. GENERATED DRAWING
DO NOT MAKE MANUAL REVISIONS TO MASTER.



ISSUE NUMBER

ORIGINAL

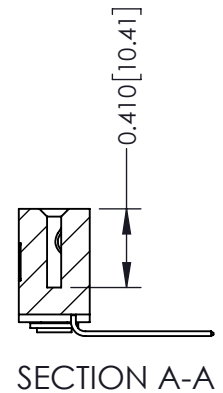
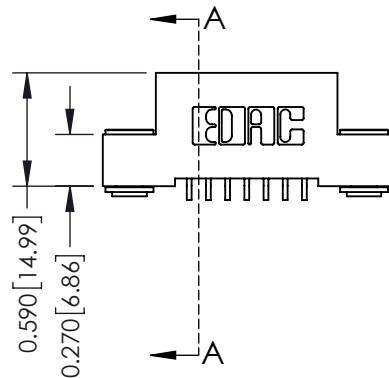
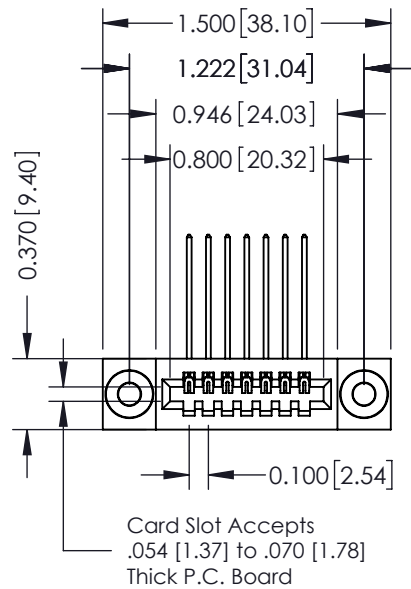

See Accompanying Pages for:

- Contact Bend Details
- Mounting Options

342 / 392 Card Edge Connector

Part Number: 342-007-559-103



EDAC INC
TORONTO, ONTARIO
CANADA

YOUR CONNECTION TO QUALITY & SERVICE

THESE DRAWINGS AND SPECIFICATIONS
ARE THE PROPERTY OF EDAC INC. AND
SHALL NOT BE REPRODUCED, OR COPIED
OR USED AS THE BASIS FOR THE
MANUFACTURE OR SALE OF APPARATUS
WITHOUT WRITTEN PERMISSION.

ACAD REFERENCE NO. 342 ENG MASTER

DRAWN: J.LEE DATE: OCT. 06/09

CHECKED: DATE:

SCALE: NTS SHEET 1 OF 3

DRAWING NUMBER 342 Assembly ISSUE 1



555 Contact Code



556 Contact Code



558 Contact Code



559 Contact Code



560 Contact Code

342 / 392 Series Card Edge Connector
Contact Bend Detail

ACAD REFERENCE NO. 342 ENG MASTER

DRAWN: J.LEE DATE: OCT. 06/09

CHECKED: DATE:

SCALE: NTS SHEET 2 OF 3

DRAWING NUMBER ISSUE

342 Assembly

1



EDAC INC
TORONTO, ONTARIO
CANADA

YOUR CONNECTION TO QUALITY & SERVICE

THESE DRAWINGS AND SPECIFICATIONS
ARE THE PROPERTY OF EDAC INC. AND
SHALL NOT BE REPRODUCED, OR COPIED
OR USED AS THE BASIS FOR THE
MANUFACTURE OR SALE OF APPARATUS
WITHOUT WRITTEN PERMISSION.

THIS IS A C.A.D. GENERATED DRAWING
DO NOT MAKE MANUAL REVISIONS TO MASTER.



ISSUE NUMBER

ORIGINAL



342 / 392 Card Edge Connector Mounting Options



EDAC INC
TORONTO, ONTARIO
CANADA

YOUR CONNECTION TO QUALITY & SERVICE

THESE DRAWINGS AND SPECIFICATIONS
ARE THE PROPERTY OF EDAC INC. AND
SHALL NOT BE REPRODUCED, OR COPIED
OR USED AS THE BASIS FOR THE
MANUFACTURE OR SALE OF APPARATUS
WITHOUT WRITTEN PERMISSION.

ACAD REFERENCE NO. 342 ENG MASTER

DRAWN: J.LEE DATE: OCT. 06/09

CHECKED: DATE:

SCALE: NTS SHEET 3 OF 3

DRAWING NUMBER ISSUE

342 Assembly

1