



200QBW4_2.25 Series

200W Quarter-Brick - Single Output DC-DC Converter - Wide Input - Isolated & Regulated

DC-DC Converter

200 Watt

- ⊕ Wide Input voltage range (4:1)
- ⊕ High efficiency up to 94%
- ⊕ Short circuit protection (SCP)
- ⊕ Input under-voltage, over-current, over-voltage, over-temperature protection
- ⊕ Isolation: 2.25KVDC
- ⊕ Operating temperature range: -40°C to +85°C
- ⊕ Five-sided metal shielding package
- ⊕ International standard pin-out: 1/4 brick

The 200QBW4_2.25 series offers 4:1 input voltage, efficiency up to 94%, 2250VDC isolation, Input under-voltage protection, output short circuit protection, over-current protection, over-voltage protection, over-temperature protection and EMI meets CISPR22/EN55022 CLASS B.

All models are widely applied in battery power supplies, industrial control, electricity, instruments, railway, communication fields.



Common specifications	
Short circuit protection:	Hiccup, continuous, automatic recovery
Cooling:	Natural (20FLM) or forced convection
Operation temperature range:	-40°C~+85°C
Storage temperature range:	-55°C ~+125°C
Over temperature protection:	+95°C MIN / +105°C TYP / +115°C MAX
Pin welding resistance temperature:	300°C MAX, 1.5mm from case for 10sec.
Storage humidity range:	< 95%
Vibration:	IEC/EN61373 car body 1 B mold
Trim:	90%Vo MIN, 110%Vo MAX
Sense:	105%Vo MAX
Case material:	Plastic [UL94-V0] / aluminium
MTBF:	500,000 hours
Weight:	83g / 103g (with base-plate) / 114g (with heatsink)

Input specifications					
Item	Test condition	Min	Typ	Max	Units
Input current	full load/no load		4579/ 100	4682/ 200	mA
Reflected ripple current	Nominal Vin and full load		100		mA
Surge voltage	1sec. max.	-0.7		90	VDC
Start-up threshold voltage	100% load			18	VDC
Input under voltage protection		14	16		VDC
Input filter	Pi Type				
Hot plug	Unavailable				
Ctrl (the voltage of Ctrl pin is relative to input pin GND)	<ul style="list-style-type: none"> • Module switch ON • Module switch OFF • Input current when switched OFF 		Ctrl suspended or connected to TTL high level (3.5-12VDC) Ctrl pin connected to GND or low level (0-1.2VDC)	2	10 mA

Output specifications						
Item	Test condition	Min	Typ	Max	Units	
Output voltage accuracy			±1	±3	%	
Line regulation			±0.2	±0.5	%	
Load regulation			±0.5	±0.75	%	
Transient recovery time	25% load step change		300	500	µs	
Transient response deviation	25% load step change • 5V output • others		±3	±5	%	
Temperature coefficient				±0.03	%/°C	
Ripple & Noise*	20MHz Bandwidth		150	250	mVp-p	
Output over-voltage protection	Input voltage range	110	130	160	%Vo	
Output over-current protection	Input voltage range	110	130	150	%Io	
Switching frequency	PWM mode		250		KHz	

*Test ripple and noise by "parallel cable" method.

Isolation specifications						
Item	Test condition	Min	Typ	Max	Units	
Isolation voltage	Tested for 1 minute and leak current less than 5mA	2250			VDC	
Isolation resistance	Insulation voltage 500VDC	100			MΩ	
Isolation capacitance	Input-output, 100KHz/0.1V		2200		pF	

Example:
200QBW4_4805S2.25
 200= 200 Watt; QB= Quarter-Brick; W4= Wide input (4:1);
 48= 18-75 Vin; 05= 5Vout; S= Single Output; 2.25= 2.25kVDC isolation

Note:

1. Operation under minimum load will not damage the converter; However, they may not meet all specification listed, and that will reduce the life of product.
2. All specifications measured at Ta=25°C, humidity<75%, nominal input voltage and rated output load unless otherwise specified.
3. In this datasheet, all the test methods of indications are based on corporate standards.

200QBW4_2.25 Series

200W Quarter-Brick - Single Output DC-DC Converter - Wide Input - Isolated & Regulated

EMC specifications

EMI	CE	CISPR22/EN55022, EN50121-3-2	CLASS A (see EMC recommended circuit)	
EMI	RE	CISPR22/EN55022, EN50121-3-2	CLASS A (see EMC recommended circuit)	
EMS	ESD	IEC/EN61000-4-2, EN50121-3-2	Contact $\pm 6\text{KV}$ /Air $\pm 8\text{KV}$	perf. Criteria B
EMI	RS	IEC/EN61000-4-3, EN50121-3-2	10V/m	perf. Criteria A
EMI*	EFT	IEC/EN61000-4-4, EN50121-3-2	$\pm 2\text{KV}$ (see EMC recommended circuit)	perf. Criteria A
EMS	Surge	EN50121-3-2	differential mode $\pm 1\text{KV}$, 1.2/50 μs , source impedance 4 Ω (see EMC recommended circuit)	perf. Criteria B
EMI	CS	IEC/EN61000-4-6, EN50121-3-2	10 Vr.m.s	perf. Criteria A

Part Number	Input Voltage [V]		Output Voltage [VDC]	Output Current [A, max]	Efficiency [%, Typ]	Capacitive load [A, max]
	Nominal	Range				
200QBW4_4812S2.25	48	18-75	12	16.7	91	2000
200QBW4_4824S2.25	48	18-75	24	8.4	91	1000
200QBW4_4848S2.25	48	18-75	48	4.2	91	450

For aluminium base-plate add suffix -BP, f.ex. 200QBW4_xxyyS2.25-BP. For heatsink add suffix -HS, f.ex. 200QBW4_xxyyS2.25-HS.

Temperature derating curves

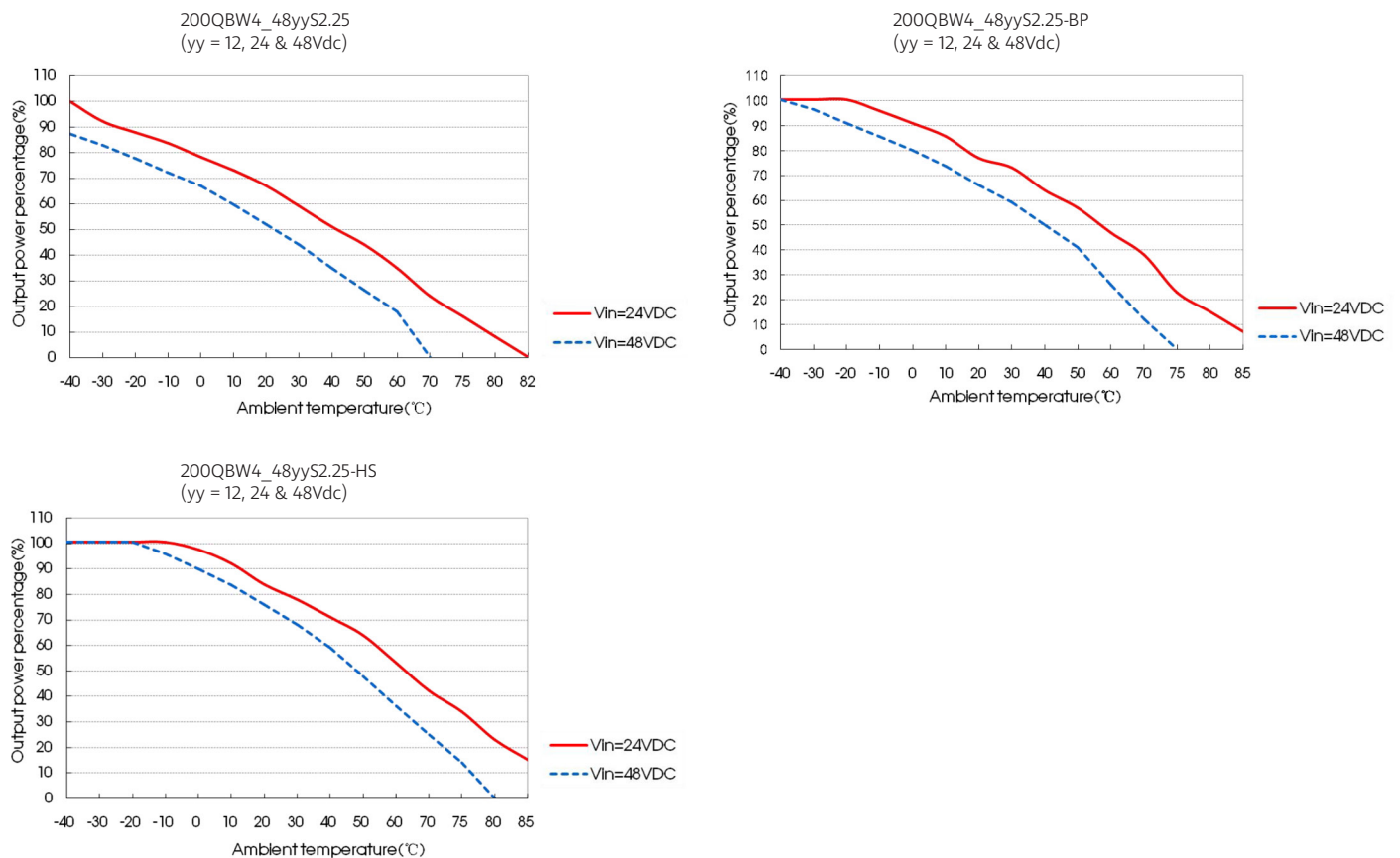

200QBW4_2.25 Series

200W Quarter-Brick - Single Output DC-DC Converter - Wide Input - Isolated & Regulated

Efficiency

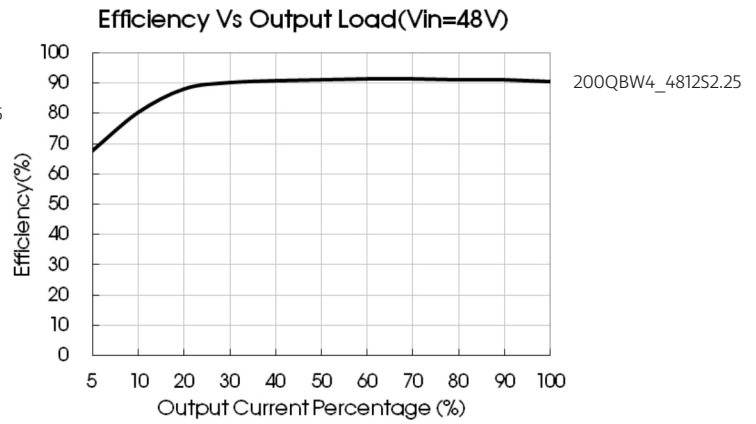
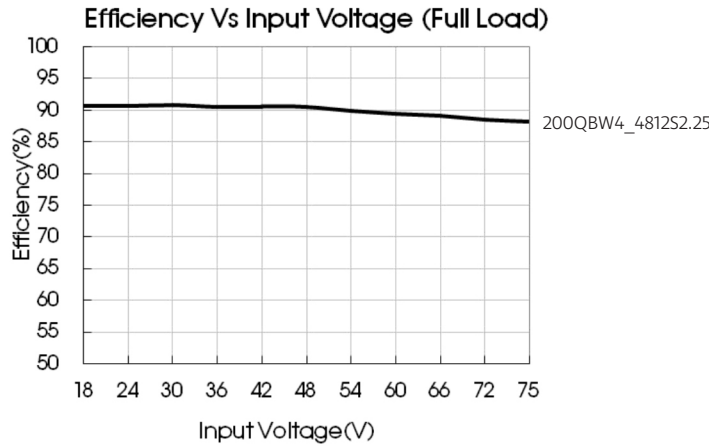

Sense of application and precautions

When not using remote sense

Notes:

1. When not using remote sense, make sure +Vo and Sense + are shorted, and that 0V and Sense- are shorted as well;
2. Keep the tracks between +Vo and Sense +, 0V and Sense- as short as possible, and close to the terminal. Avoid a looping track. If noise interferes the loop, the operation of the power module will become unstable.

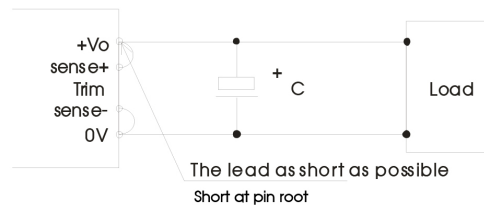

When remote sense is used

Notes:

1. Using remote sense with long wires may cause output voltage to become unstable. Consult us if long sensing wiring is necessary.
2. Sense tracks or wires should be as short as possible. If using wires, it should not use twisted-pair or shielded wires.
3. Please use wide PCB tracks or a thick wires between the power supply module and the load, the line voltage drop should be kept less than 0.3V. Make sure the power supply module's output voltage remains within the specified range.
4. The impedance of wires may cause the output voltage oscillation or a greater ripple, please take adequate assessments before using.

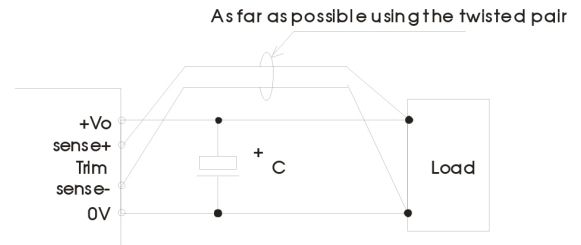

Typical application

If not using Gaptec's recommended circuit, please ensure an 220µF electrolytic capacitors in parallel with the input, which used to suppress the surge voltage come from the input terminal. All the DC/DC converters of this series are tested according to the recommended circuit (see Fig. 1) before delivery.

If it is required to further reduce input&output ripple, properly increase the input & output of additional capacitors Cin and Cout or select capacitors of low equivalent impedance, provided that the capacitance is no larger than the max. capacitive load of the product.

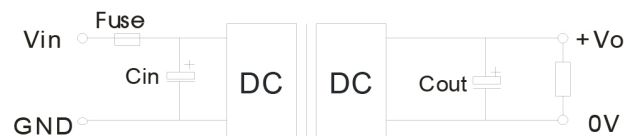

Vout (VDC)	Fuse	Cin	Cout
12	20A, slow blow	220µF	220µF
24	20A, slow blow	220µF	100µF
48	20A, slow blow	220µF	100µF

200QBW4_2.25 Series

200W Quarter-Brick - Single Output DC-DC Converter - Wide Input - Isolated & Regulated

EMC solution recommended circuit

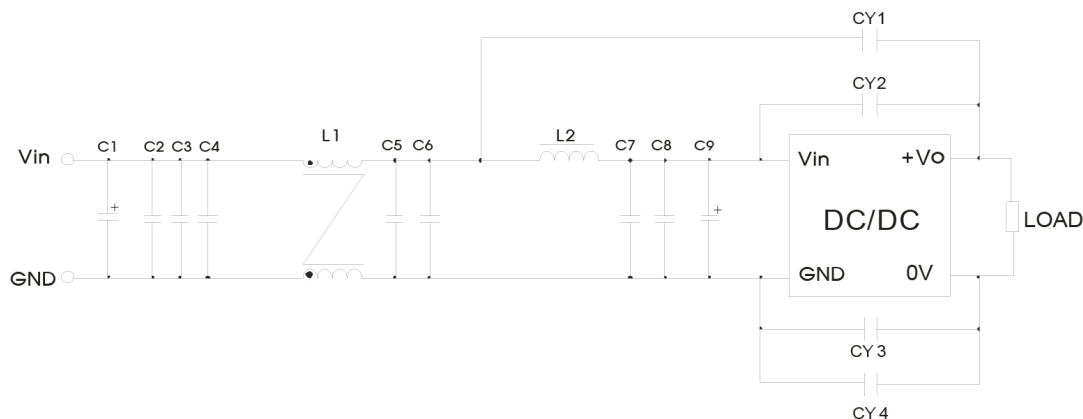

Device number	Device parameter	Device function
C1	150µF electrolytic capacitor	Meet puise group and surge
C9	47µF electrolytic capacitor	
C1	150µF electrolytic capacitor	Meet conducted emission and radiated emission
C9	47µF electrolytic capacitor	
C2, C3, C4, C5, C6, C7, C8	2.2µF ceramic capacitor	
L1	1.0mH common mode inductor	
L2	1.5µH inductance	
CY1, CY2, CY3, CY4	1nF Y1 safety capacitor	

Trim application & trim resistance

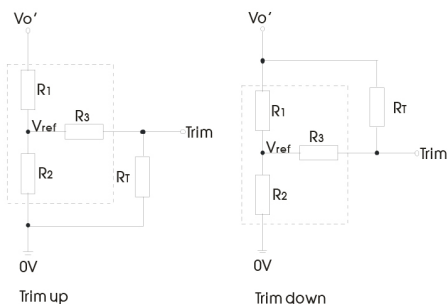

Calculation formula of Trim resistance:

$$\begin{aligned} \text{up: } R_T &= \frac{aR_2}{R_2 - a} - R_3 & a &= \frac{V_{ref}}{V_o' - V_{ref}} \cdot R_1 \\ \text{down: } R_T &= \frac{aR_1}{R_1 - a} - R_3 & a &= \frac{V_o' - V_{ref}}{V_{ref}} \cdot R_2 \end{aligned}$$

Application circuit for TRIM (Part in broken line is the interior of models)
Note: RT is Trim resistance, a is a self-defined parameter, with no real meaning. Vo' for the actual needs of the up or down regulated voltage.

It is not allowed to connect modules output in parallel to enlarge the power.

Vout(V)	R1(KΩ)	R2(KΩ)	R3(KΩ)	Vref(V)
12	11.000	2.87	15	2.5
24	24.872	2.87	15	2.5
48	53.017	2.913	15	2.5

Reflected ripple current



Note: Lin(4.7µH) , Cin(220µF, ESR < 1.0Ω at 100 KHz)

200QBW4_2.25 Series

200W Quarter-Brick - Single Output DC-DC Converter - Wide Input - Isolated & Regulated

Mechanical dimensions

200QBW4_xxyyS2.25

THIRD ANGLE PROJECTION 

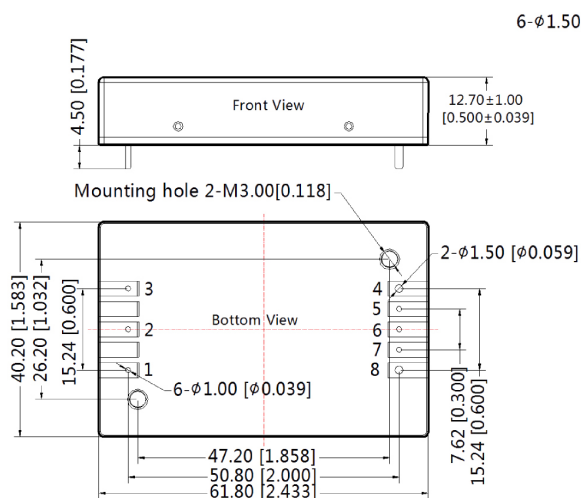

Note:
Unit: mm[inch]
Pin1, 2, 3, 5, 6, 7's diameter: 1.00[0.039]
Pin4, 8's diameter: 1.50[0.059]
Pin diameter tolerances: $\pm 0.10[\pm 0.004]$
General tolerances: $\pm 0.50[\pm 0.020]$
Mounting hole screwing torque: Max 0.4 N·m

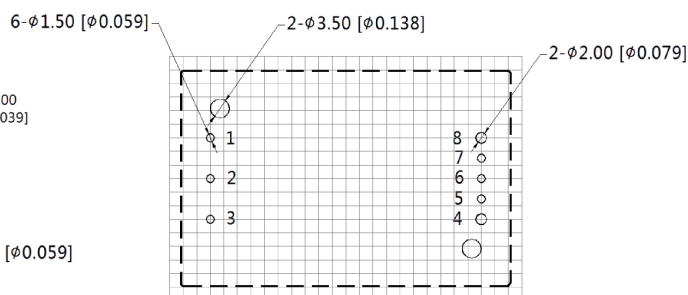

Note:Grid 2.54*2.54mm

Pin-Out			
Pin	Function	Pin	Function
1	+Vin	5	Sense-
2	Ctrl	6	Trim
3	-Vin	7	Sense+
4	0V	8	+Vo

Base-plate dimensions and recommended layout

200QBW4_xxyyS2.25-BP

THIRD ANGLE PROJECTION 

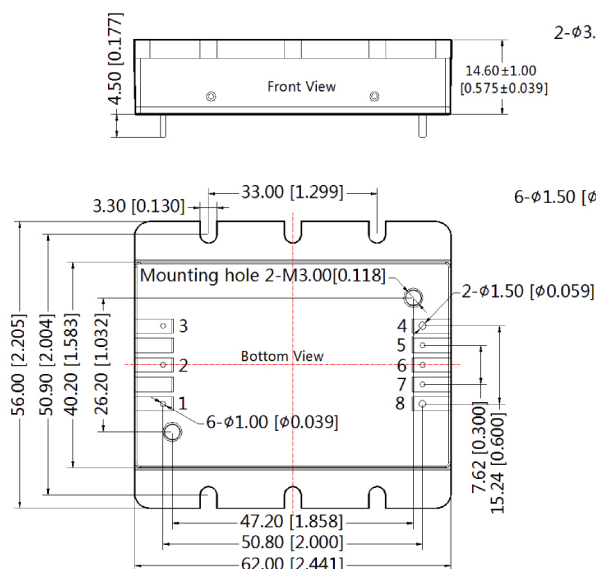

Note:
Unit: mm[inch]
Pin1, 2, 3, 5, 6, 7's diameter: 1.00[0.039]
Pin4, 8's diameter: 1.50[0.059]
Pin diameter tolerances: $\pm 0.10[\pm 0.004]$
General tolerances: $\pm 0.50[\pm 0.020]$
Mounting hole screwing torque: Max 0.4 N·m

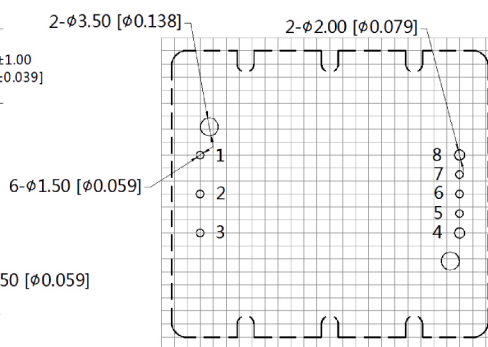

Note:Grid 2.54*2.54mm

Pin-Out			
Pin	Function	Pin	Function
1	+Vin	5	Sense-
2	Ctrl	6	Trim
3	-Vin	7	Sense+
4	0V	8	+Vo

200QBW4_2.25 Series

200W Quarter-Brick - Single Output DC-DC Converter - Wide Input - Isolated & Regulated

Heatsink dimensions and recommended layout

200QBW4_xxyyS2.25-HS

THIRD ANGLE PROJECTION 

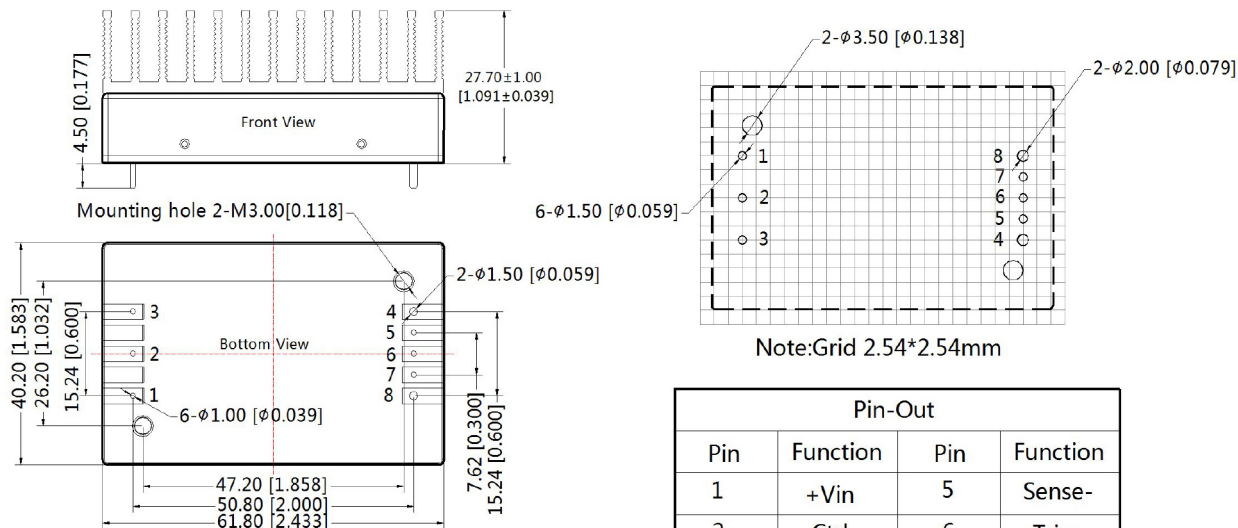

Note:

Unit: mm[inch]

Pin1, 2, 3, 5, 6, 7's diameter: 1.00[0.039]

Pin4, 8's diameter: 1.50[0.059]

Pin diameter tolerances: $\pm 0.10[\pm 0.004]$

General tolerances: $\pm 0.50[\pm 0.020]$

Mounting hole screwing torque: Max 0.4 N·m

Pin-Out

Pin	Function	Pin	Function
1	+Vin	5	Sense-
2	Ctrl	6	Trim
3	-Vin	7	Sense+
4	0V	8	+Vo