

# PE44820 Evaluation Kit (EVK) User's Manual

## *UltraCMOS<sup>®</sup> RF Digital Phase Shifter*

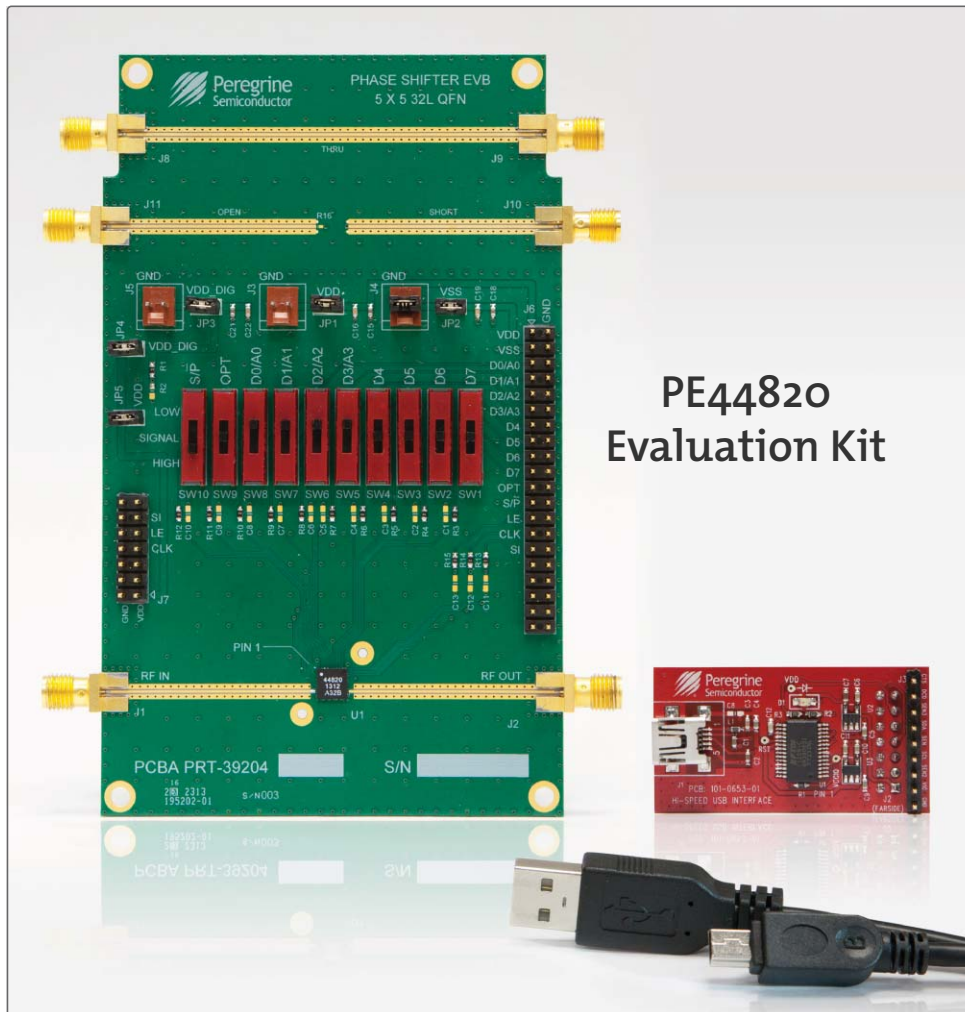

## Copyright and Trademarks

©2015, Peregrine Semiconductor Corporation. All rights reserved. The Peregrine name, logo, UTSi and UltraCMOS are registered trademarks and HaRP, MultiSwitch and DuNE are trademarks of Peregrine Semiconductor Corp.

## Disclaimers

The information in this document is believed to be reliable. However, Peregrine assumes no liability for the use of this information. Use shall be entirely at the user's own risk. No patent rights or licenses to any circuits described in this document are implied or granted to any third party. Peregrine's products are not designed or intended for use in devices or systems intended for surgical implant, or in other applications intended to support or sustain life, or in any application in which the failure of the Peregrine product could create a situation in which personal injury or death might occur. Peregrine assumes no liability for damages, including consequential or incidental damages, arising out of the use of its products in such applications.

## Patent Statement

Peregrine products are protected under one or more of the following U.S. patents: [patents.psemi.com](http://patents.psemi.com)

## Sales Contact

For additional information, contact Sales at [sales@psemi.com](mailto:sales@psemi.com).

## Corporate Headquarters

9369 Carroll Park Drive, San Diego, CA, 92121  
858-731-9400

# Table of Contents

<b>Introduction</b> - - - - -	<b>1</b>
<b>Introduction</b> - - - - -	<b>1</b>
Application Support .....	1
Evaluation Kit Contents and Requirements .....	1
Kit Contents .....	1
Software Requirements .....	2
Hardware Requirements .....	2
<b>Evaluation Board Assembly</b> - - - - -	<b>3</b>
<b>Evaluation Board Assembly Overview</b> - - - - -	<b>3</b>
<b>Quick Start Guide</b> - - - - -	<b>5</b>
<b>Quick Start Overview</b> - - - - -	<b>5</b>
<b>Software Installation</b> - - - - -	<b>5</b>
USB Driver .....	5
EVK Software .....	5
<b>Hardware Configuration</b> - - - - -	<b>8</b>
USB Interface Board Overview .....	8
Connection of the USB Interface Board to the Evaluation Board .....	8
Serial Mode USB Supply Configuration .....	9
Parallel Mode Configuration .....	10
Evaluation Board Overview .....	11
<b>Using the Graphical User Interface</b> - - - - -	<b>13</b>
Functions .....	14
Connection Status .....	14
Part Number .....	14
Part Description .....	14
Serial Interface Waveform .....	14
Send Button .....	14
Phase Slider .....	15

Phase Value .....	15
Continuous Pattern Loop .....	15
Lookup Table .....	16
Phase Shifter Graphic .....	16
Help .....	17

**Technical Resources - - - - -19**

**Technical Resources - - - - -19**

**Document Categories - - - - -21**

# Introduction



## Introduction

The PE44820 is an 8-bit 1.7–2.2 GHz monolithic RF digital phase shifter (DPS) fabricated in Peregrine's UltraCMOS<sup>®</sup> silicon-on-sapphire (SOS) process technology. This highly versatile DPS features a 358.6 degree phase shift in 1.40625 degree steps and contains 1.4 degree phase accuracy optimization bit used to optimize the phase accuracy across any given phase state. PE44820 provides a flexible CMOS control interface which supports parallel and serial programming modes, and includes an optional  $V_{SS}$  feature. PE44820 is available in a 32-lead 5 × 5 mm QFN footprint. No blocking capacitors are required if DC voltage is not present on the RF ports.

The PE44820 evaluation kit (EVK) includes hardware required to control and evaluate the functionality of the DPS. The DPS evaluation software can be downloaded at [www.psemi.com](http://www.psemi.com) and requires a PC running Windows<sup>®</sup> operating system to control the USB interface board.

## Application Support

For any technical inquiries regarding the evaluation kit or software, please visit applications support at [www.psemi.com](http://www.psemi.com) (fastest response) or call (858) 731-9400.

## Evaluation Kit Contents and Requirements

### Kit Contents

The PE44820 evaluation kit (EVK) includes the following hardware required to evaluate the DPS.

Table 1 • PE44820 Evaluation Kit Contents

Quantity	Description
1	PE44820 DPS evaluation board assembly (PRT-39204)
1	Peregrine USB interface board assembly (PRT-53581)
1	USB 2.0 USB-A to USB-mini B cable assembly

### **Software Requirements**

The DPS evaluation software will need to be installed on a computer with the following minimum requirements:

- PC compatible with Windows® operating system (XP/Vista/7/8)–32-bit or 64-bit
- Mouse or other pointing device
- USB port
- Web browser with internet access

### **Hardware Requirements**

In order to evaluate the phase shift performance of the evaluation board, the following equipment is required:

- Serial mode USB powered
  - Vector network analyzer
- Parallel mode external powered
  - Vector network analyzer
  - DC power supply
  - DC test leads

**Caution:** The PE44820 DPS EVK contains components that might be damaged by exposure to voltages in excess of the specified voltage, including voltages produced by electrostatic discharges. Handle the board in accordance with procedures for handling static-sensitive components. Avoid applying excessive voltages to the power supply terminals or signal inputs or outputs.

# Evaluation Board Assembly

2

## Evaluation Board Assembly Overview

The evaluation board (EVB) is assembled with a PE44820 digital phase shifter (DPS), SP3T mechanical switches (SW1–SW10), several headers and SMA connectors. SW10 (P/S) switch is used for parallel or serial mode selection. SW1–SW8 switches are used for setting the control bits in direct-parallel programming mode (Figure 1).

Figure 1 • PE44820 Evaluation Board Assembly

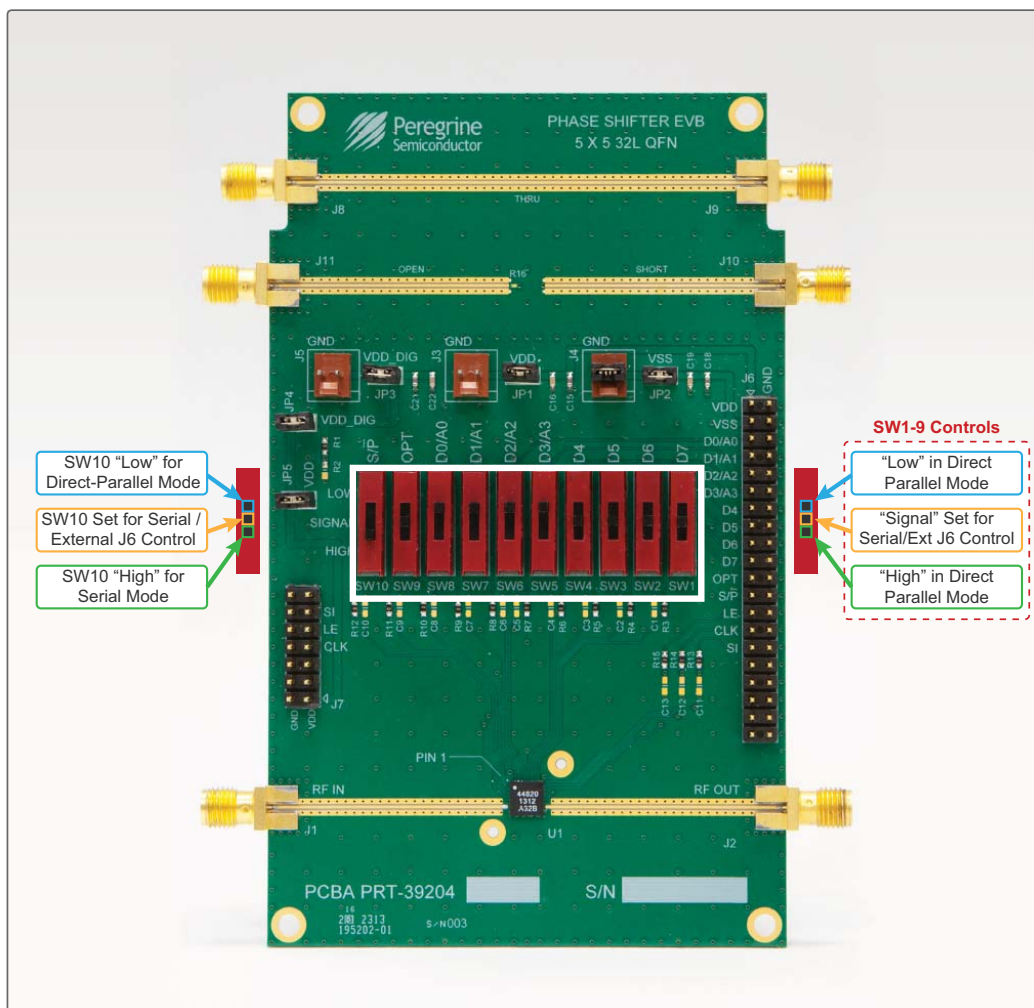

This page intentionally left blank.



# Quick Start Guide



## Quick Start Overview

The EVB was designed to ease customer evaluation of the PE44820 digital phase shifter (DPS). This chapter will guide the user through the software installation, hardware configuration and using the graphical user interface (GUI).

## Software Installation

### USB Driver

The latest USB interface board drivers are available via Microsoft Windows update. Internet connectivity is required to download the drivers. Connect the USB interface board to the PC and select the Windows Update option to obtain and install the drivers (Figure 2).

If the USB interface board drivers are not installed, it will not be possible to run the program directly. Once the board drivers are installed, the USB interface will be recognized by the Device Manager within Windows (Figure 3).

Figure 2 • USB Driver Installation (Detecting)

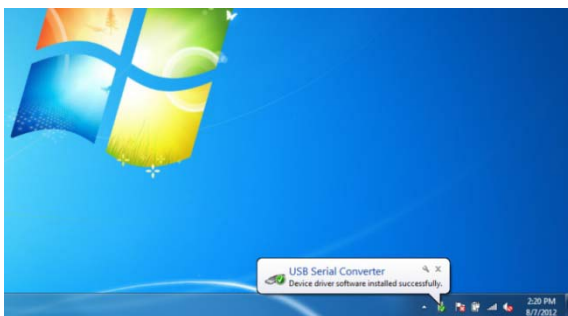
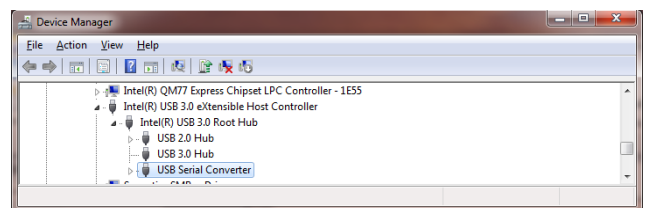

Figure 3 • USB Driver Installation (Device Manager)



### EVK Software

In order to evaluate the PE44820 performance, the application software has to be installed on your computer. The USB interface and DPS application software is compatible with computers running Windows® 2000, XP, Vista, 7, 8, in 32-or 64-bit configurations. This software is available directly from Peregrine's website at [www.psemi.com](http://www.psemi.com).

To install the DPS evaluation software, unzip the archive and execute the "setup.exe."

Figure 4 • DPS Evaluation Software Installer

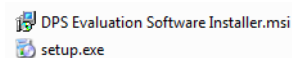

After the setup.exe file has been executed, the installer may prompt you to install Windows Installer 3.1 or Microsoft® .NET Framework 4.0. Follow the instructions as prompted to download and install these packages directly from Microsoft.

Next, a welcome screen will appear. It is strongly recommended that all programs be closed prior to running the install program. Click the “Next>” button to proceed.

Figure 5 • *DPS Evaluation Software Setup*

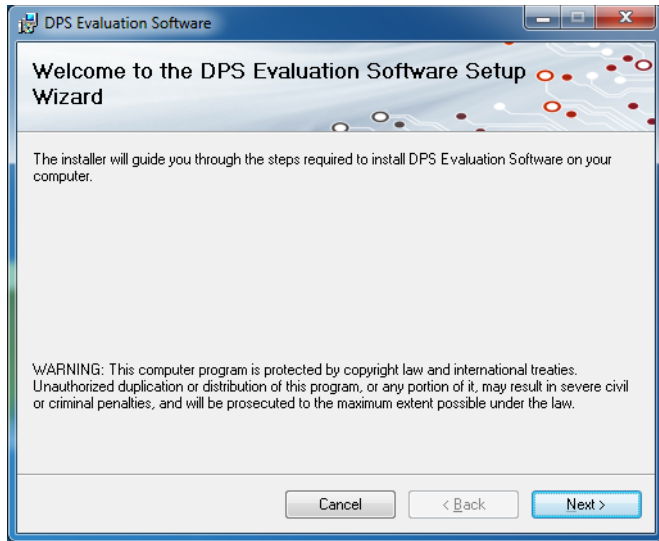

Take a moment to read the license agreement, then click “I Agree” and “Next>.”

Figure 6 • *License Agreement*

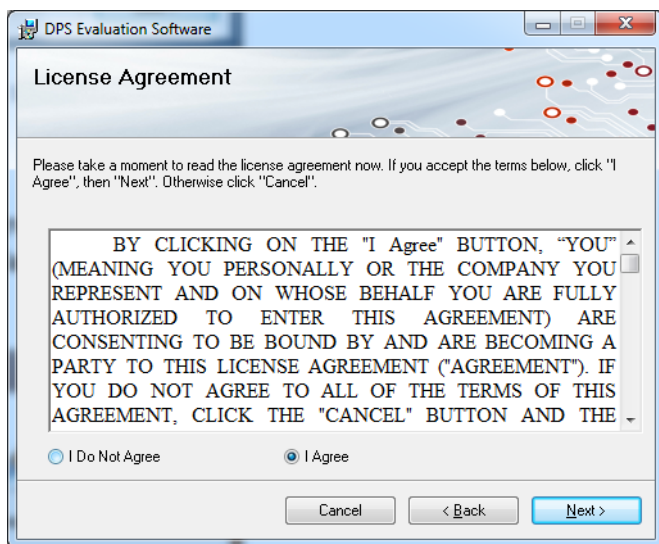

For most users the default install location for the program files is sufficient. If a different location is desired, the install program can be directed to place the program files in an alternate location. The software is installed for “Everyone” by default. Once the desired location is selected click “Next>.”

Figure 7 • *Select Installer Folder*

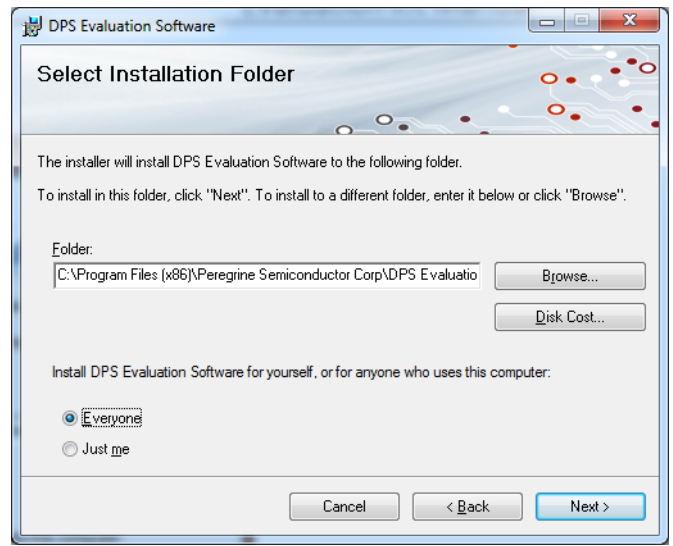

In the window of Confirm Installation, click “Next>” to proceed with the software installation.

Figure 8 • *Confirm Installation*

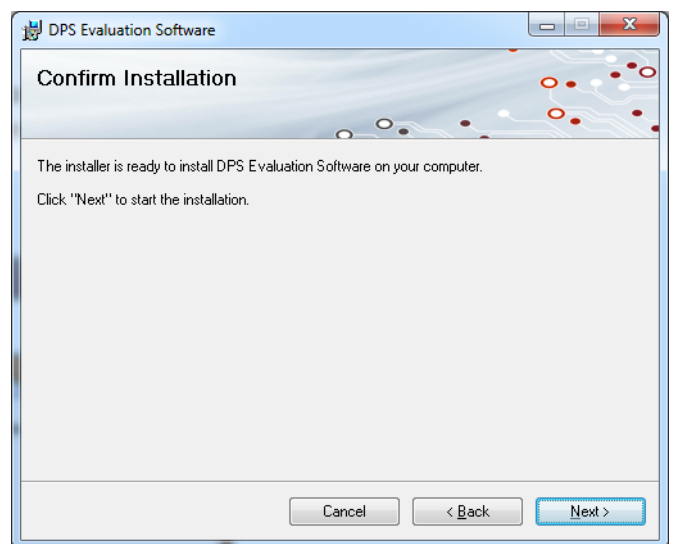

As the software files are installed, a progress indicator will be displayed. On slower computers, installation of the software may proceed for a few moments.

**Figure 9 • Progress Indicator**

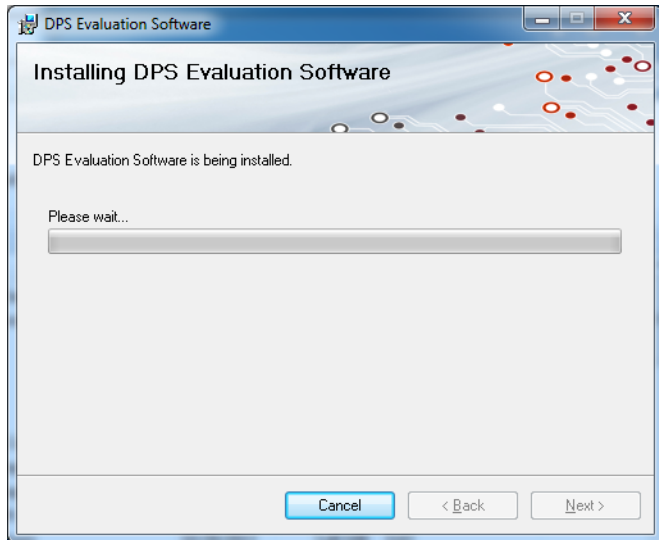

Once the evaluation software is installed, click "Close" to exit.

**Figure 10 • Installation Complete**

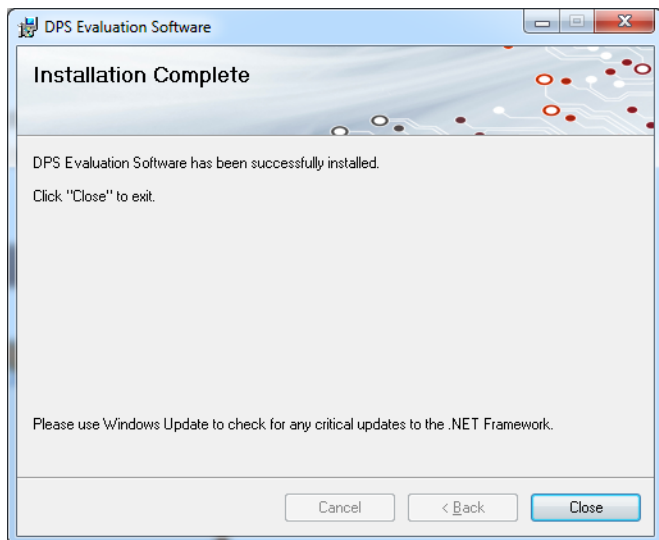

If using Windows XP, Vista or 7 operating system, a new Start Menu under Peregrine Semiconductor will appear in the start menu of your computer. Select "DPS Evaluation Software" to launch the GUI.

**Figure 11 • DPS Evaluation Software Launch**

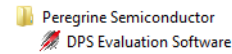

If using Windows 8 operating system, show all applications on the tile screen, then navigate to Peregrine Semiconductor Corp, and click on "DPS Evaluation Software." You can also right click on the "DPS Evaluation Software" application and select "Pin to Start" to add an icon to the Start Menu to run the application.

## Hardware Configuration

The EVB can be configured to operate in serial mode using the GUI, parallel mode using the switches located on the EVB or driven by external digital logic.

### USB Interface Board Overview

The USB interface board (**Figure 12**) is included in the evaluation kit. This board allows the user to send serial peripheral interface (SPI) commands to the device under test by using a PC running the Windows® operating system. To install the software, extract the zip file to a temporary directory and follow the installation procedure included.

**Figure 12 • USB Interface Board**

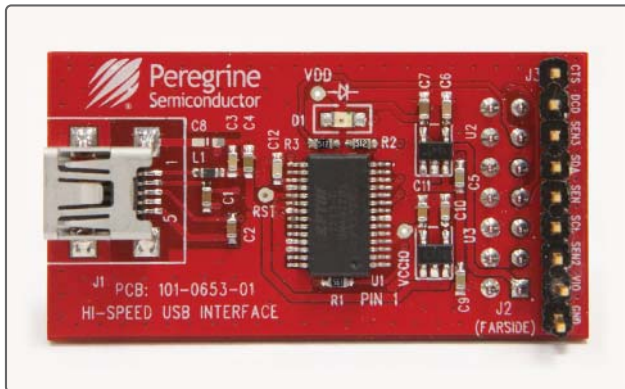

### Connection of the USB Interface Board to the Evaluation Board

The EVB and the USB interface board contain a 14 pin 100 mil dual row header. This feature allows the USB interface board (socket) to connect directly to the EVB (header) on the front side as show in **Figure 13**. Use caution when making the connection to ensure the USB interface board is aligned and connected to both rows of pins properly.

**Figure 13 • USB Interface Board Connected to the PE44820 EVB**

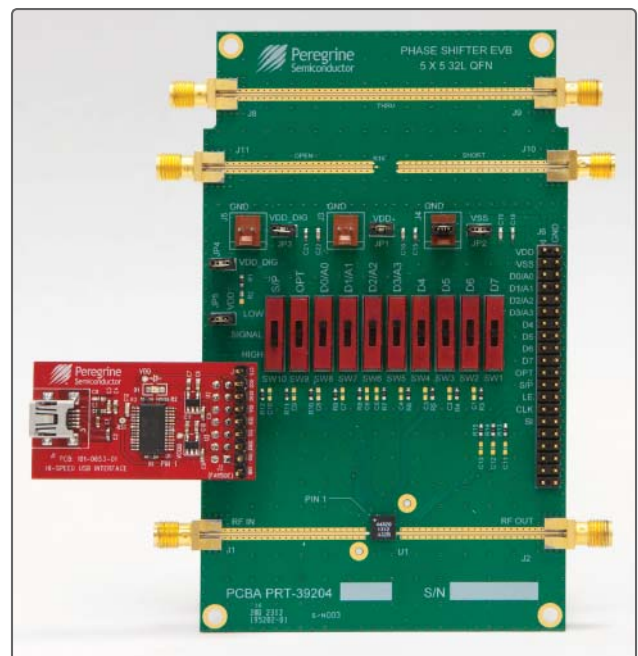

## Serial Mode USB Supply Configuration

To operate the PE44820 EVB in serial mode with VDD and VDD\_DIG supplied by the USB interface board, verify the following switch/jumper settings (**Figure 14**):

- Remove USB connection from USB interface board (removed power).
- Set SW1–4 and SW9 to SIGNAL (middle) position (controlled by the USB interface board).
- Set SW5–8 to LOW.
- Set SW10 to HIGH.
- Install JP5 and JP4 (USB interface board supplies VDD and VDD\_DIG).
- Install JP1, JP2, JP3 and JP4 (connect VDD, VSS, VDD\_DIG and GND to board connections).
- Use “THRU” trace between J8 and J9 for board trace loss calibration.
- Use “OPEN” trace at J11 for vector network analyzer port extension.
- Use “SHORT” trace at J10 for vector network analyzer port extension.
- Attach the USB connection to the USB interface board.

**Figure 14 • PE44820 EVB Serial Mode USB Supply Configuration**

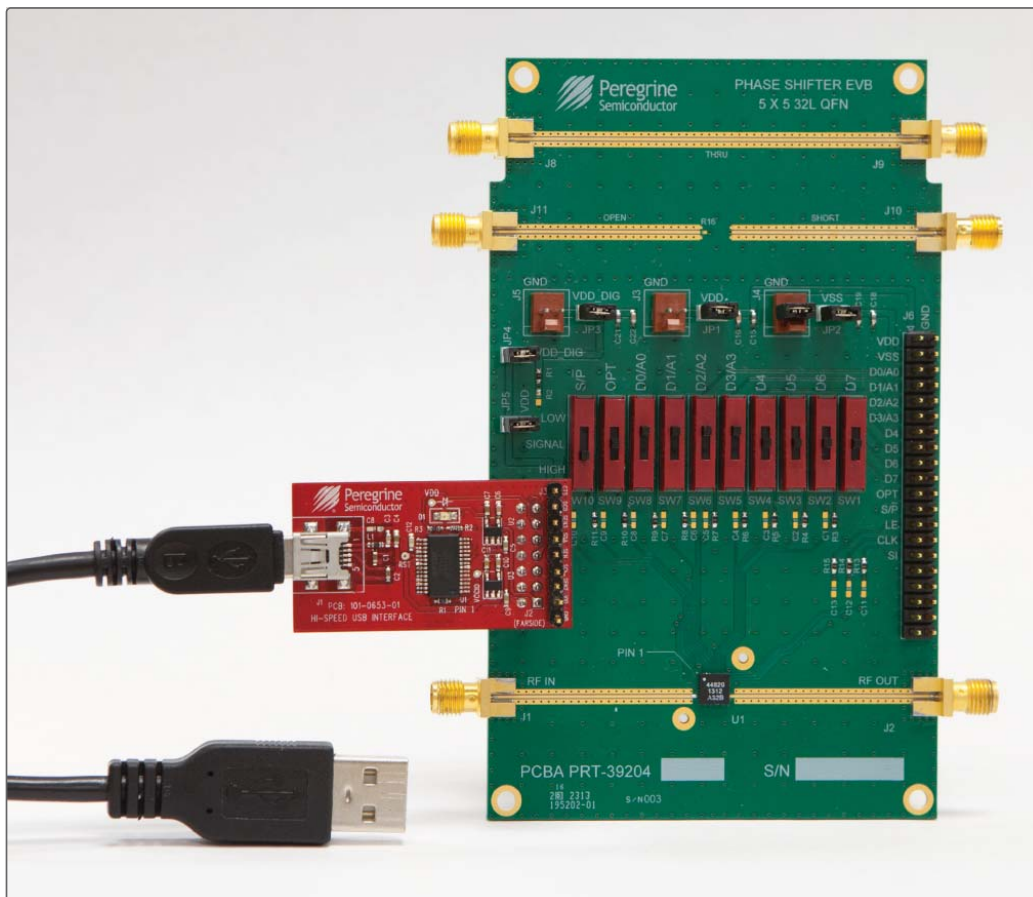

## Parallel Mode Configuration

To operate PE44820 EVB in parallel mode, verify the following switch/jumper settings (**Figure 15**):

- Verify that all DC power supplies are turned off before proceeding.
- Set SW1-10 to LOW.
- Remove JP4 and JP5 jumpers.
- Install JP3, JP1, JP2 and J4 jumpers (VDD\_DIG, VDD, VSS and GND to board connections).
- Connect VDD and VDD\_DIG externally to the PE44820. Typically VDD\_DIG and VDD are set to 2.8V. Refer to the datasheet for VDD\_DIG and VDD voltage ranges.
- Verify that VDD is the positive power supply.
- Verify that VDD\_DIG is the positive power supply for control signals (it can be provided with VDD to simplify the test setup).
- Verify that VSS is the external negative power supply (it can also be short to GND to use the internal negative voltage generator and simplify the test setup).
- Use “THRU” trace between J8 and J9 for board trace loss calibration.
- Use “OPEN” trace at J11 for vector network analyzer port extension.
- Use “SHORT” trace at J10 for vector network analyzer port extension.

**Figure 15 • PE44820 Evaluation Board Parallel Mode External Supply Configuration**

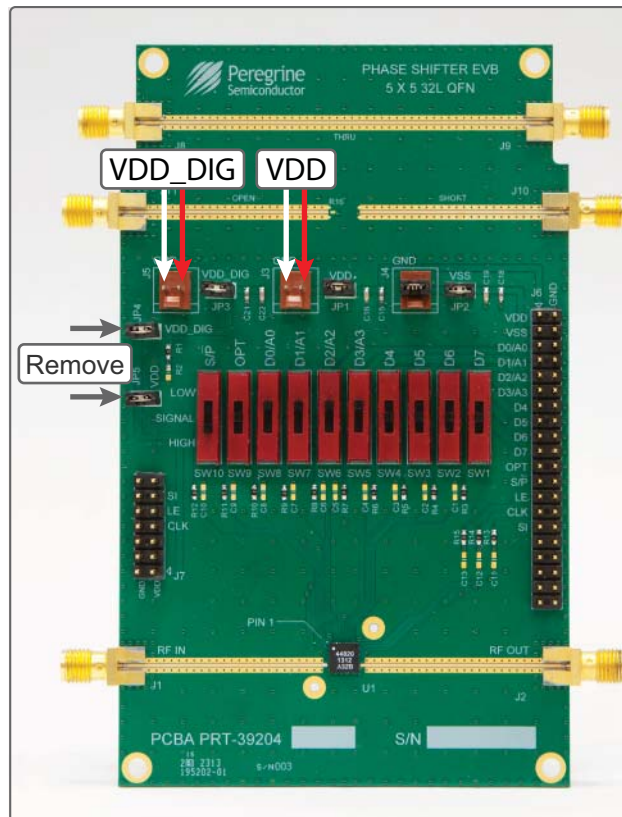

## Evaluation Board Overview

The evaluation board is designed to ease customer evaluation of Peregrine's products. The board contains:

- 1) Switches for digital control signals and programming selectivity.
- 2) Header pins for power supplies, jumpers and the USB interface board.
- 3) SMA connectors for RF performance verification and THRU traces for board loss calibration.

The schematic and evaluation board outline are provided in this user manual.

Figure 16 • PE44820 Evaluation Board Schematic

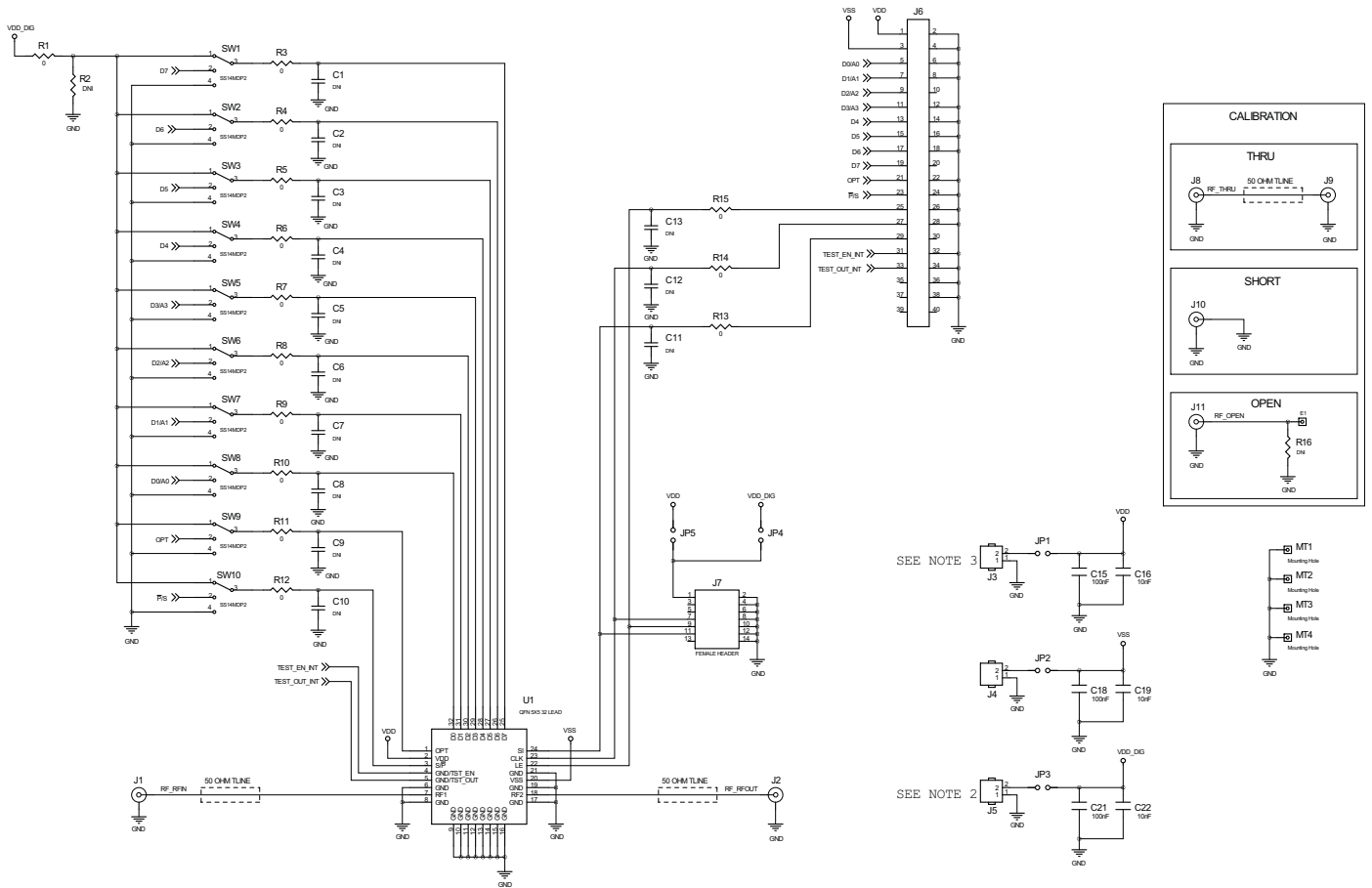

NOTES:

1. USE PCB PART NUMBER PRT-39205-01.
2. 1.8V SHOULD BE APPLIED TO J5 WHEN JP4 IS REMOVED AND JP3 IS INSTALLED.
3. 2.3V - 5.5V SHOULD BE APPLIED TO J3 WHEN JP5 IS REMOVEWD AND JP1 IS INSTALLED.

Figure 17 • PE44820 Evaluation Board Outline Showing Functional Overview

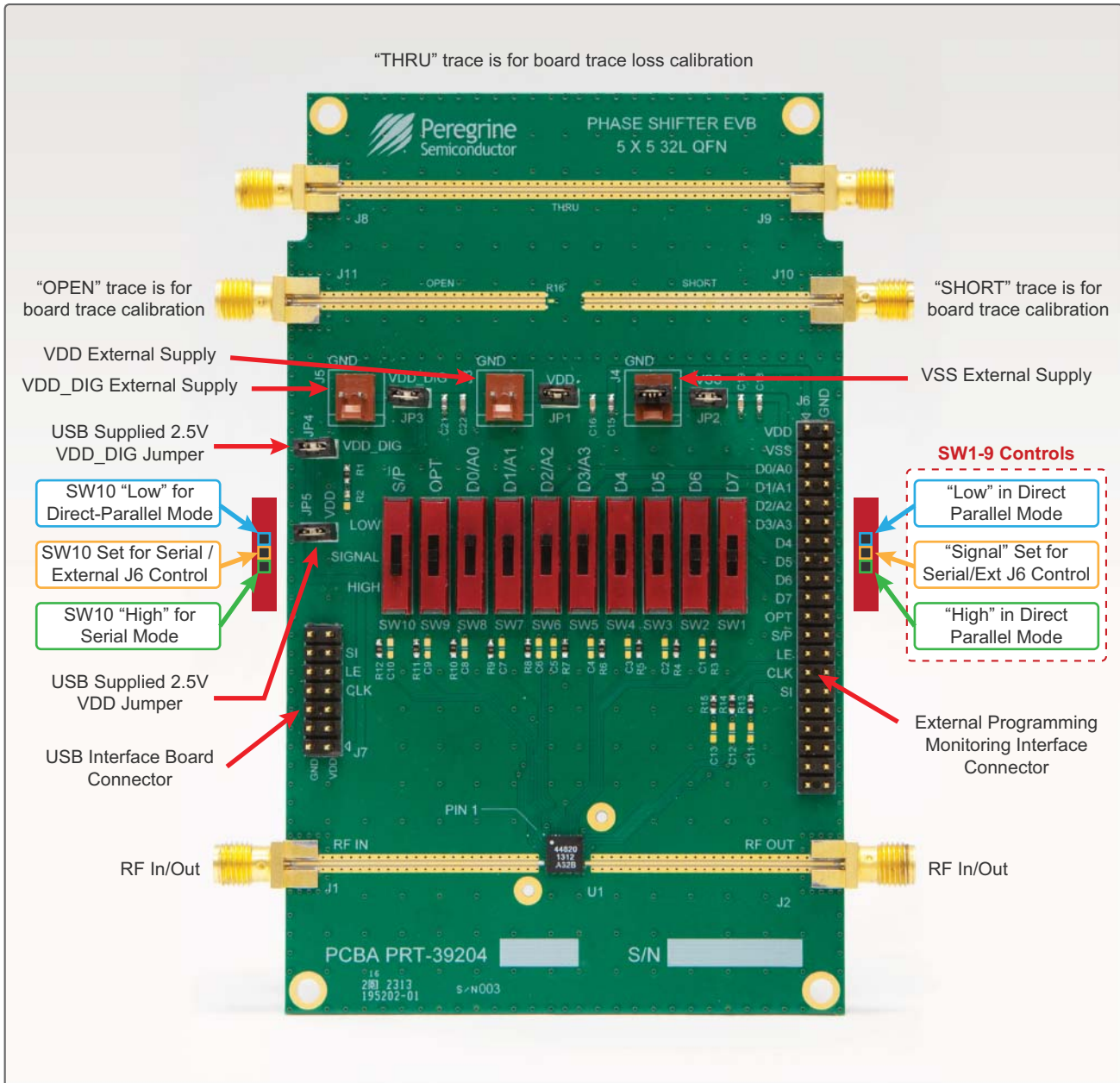



## Using the Graphical User Interface

The DPS application software graphical user interface (GUI) is displayed in **Figure 18** and illustrates the available controls and messages available to the user.

**Figure 18 • DPS Evaluation Software Graphical User Interface**

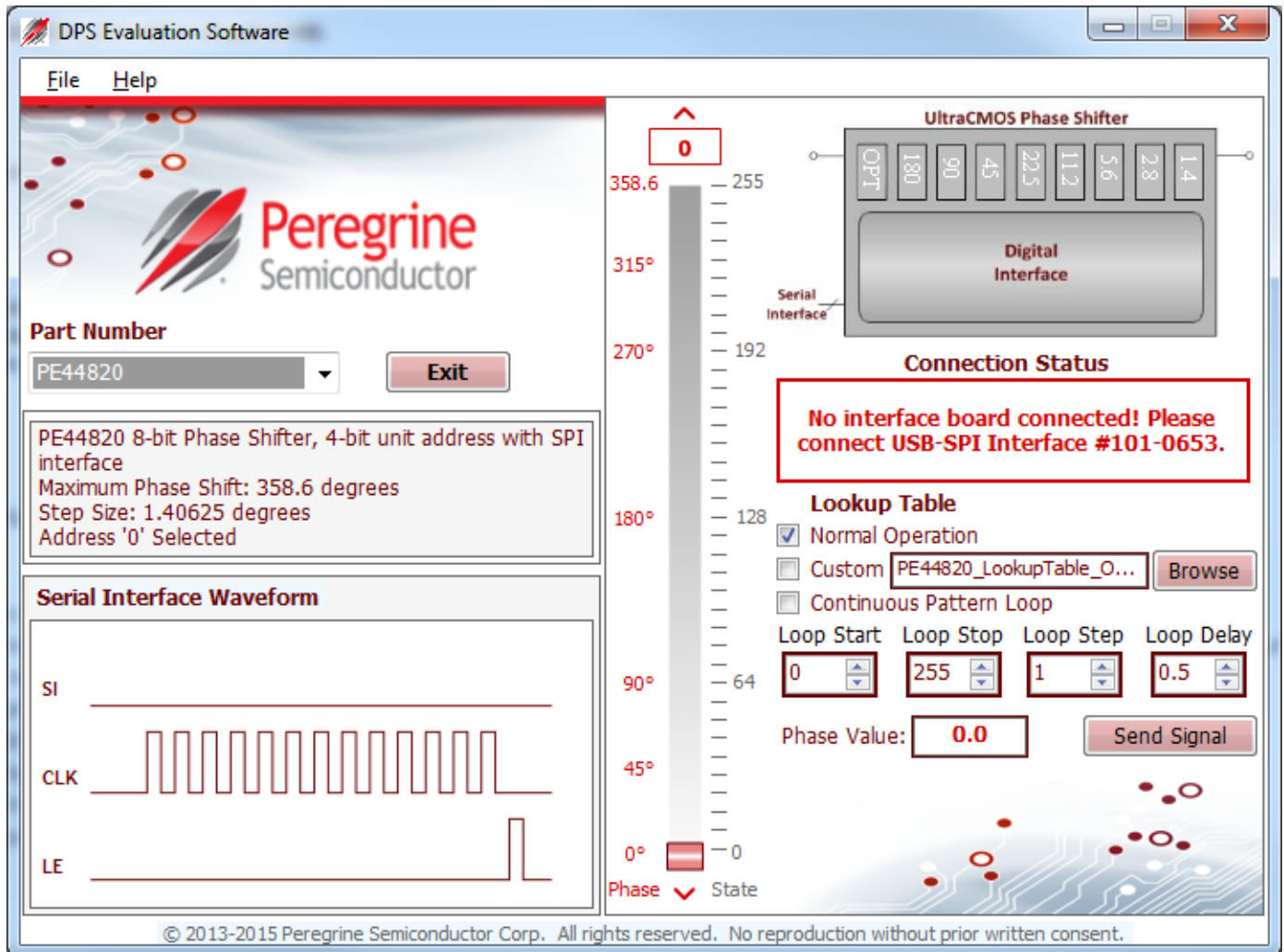

## Functions

### Connection Status

The connection status box is located in the upper right area of the GUI, below the block diagram of the phase shifter (see **Figure 19**) and indicates if the USB interface board is connected to the computer. Verify the Connection Status field is green and contains the message “**Hi-Speed USB-SPI Interface Board #101-0653 connected.**” This indicates that the GUI has established communication with the red USB interface board and is ready to be used.

Figure 19 • Connection Status

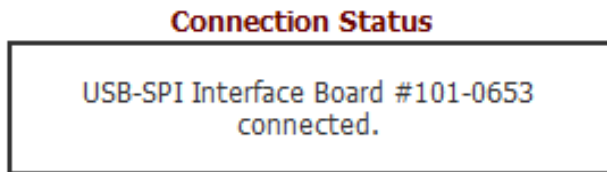

If the USB interface board is not connected when the application is launched, the message “**No interface board connected! Please connect Hi-Speed USB-SPI Interface Board #101-0653.**” will appear at the bottom of the screen. Typically this can be corrected by reinserting the USB interface board connection cable from your PC. The GUI is successfully installed when the driver is loaded in the Device Manager (see **Figure 3**). Restart the DPS evaluation software and verify that the Connection Status field is green.

### Part Number

In the upper left corner under the Peregrine logo, there is a drop down menu item to select the part for evaluation (see **Figure 20**).

Figure 20 • Part Number Selection

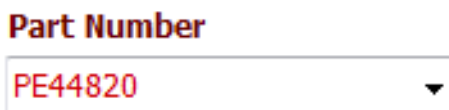

### Part Description

The part description information box is located directly below the part number drop down menu (see **Figure 21**) and displays information pertinent to the selected device. This includes the maximum phase shift value, step size and serial address (A0–A3) of the device.

Figure 21 • Part Description Information Box

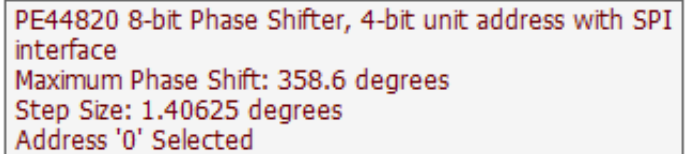

### Serial Interface Waveform

The Serial Interface Waveform window (see **Figure 22**) displays the most recent waveform programmed into the device.

Figure 22 • Serial Interface Waveform

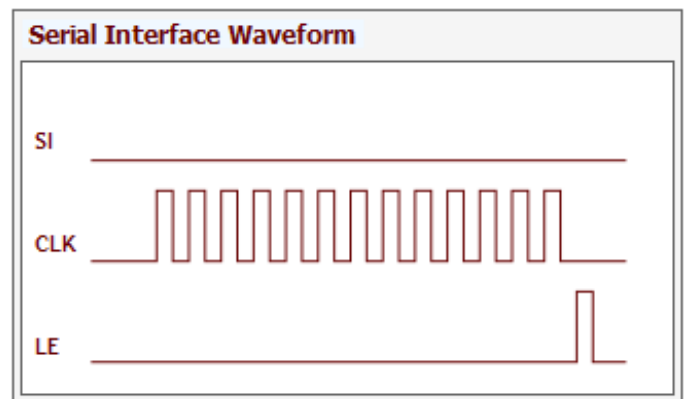

### Send Button

The Send Button (see **Figure 23**) sends the programming waveform to the device at the same phase value.

Figure 23 • Send Signal Button

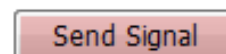

**Phase Slider**

In the center of the GUI is the phase slider (see **Figure 24**). This allows the user to quickly select the desired phase shift. The states and phase values automatically change to valid values based on the capability of the part number selected. The arrows at the top and bottom can be clicked to increase or decrease the phase state at the minimum step size. Each time the phase slider is changed, the hardware is programmed with the updated value displayed in the phase value text box (see **Figure 25**).

**Figure 24 • Phase Slider**

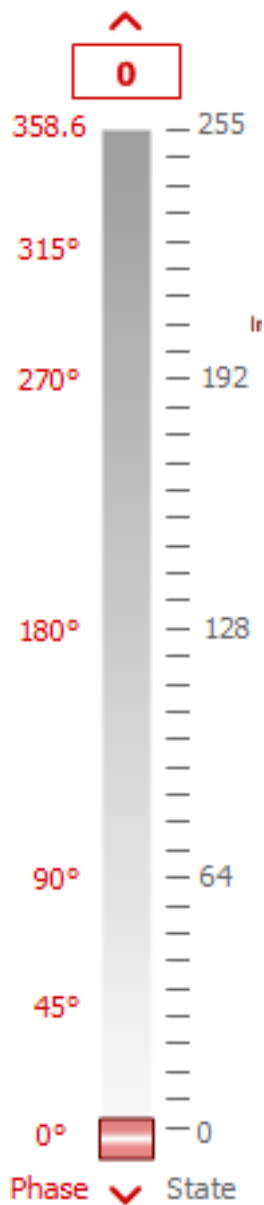

**Phase Value**

The Phase Value text box (see **Figure 25**) is updated with each change of the phase slider. This control is two-way; the user can also enter a valid phase value into this text box followed by the ENTER key to program the hardware with the updated value. This is useful in comparing phase steps.

**Figure 25 • Phase Value Text Box**

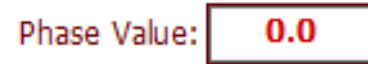

**Continuous Pattern Loop**

The Continuous Pattern Loop checkbox combined with the Loop Start, Loop Stop and Loop Step numeric controls (see **Figure 26**) allow the user to observe the evaluation board automatically step through each of the phase states within the defined range and step size. Once the GUI reaches the Loop Stop value the cycle begins again at the Loop Start. The delay between state changes is controlled by the Loop Delay numeric control (see **Figure 26**).

**Figure 26 • Continuous Pattern Loop**

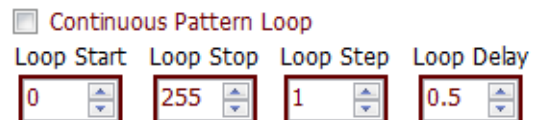

### Lookup Table

In Serial mode using the DPS evaluation software, the PE44820 can be operated in two modes through the Lookup Table (see **Figure 27**). The Default mode programs the PE44820 via the slider from 0–255 states, where each state LSB = 1.40625°. The OPT bit is tied to the 90° bit per the datasheet. In Custom mode the user must select a custom compensation file in CSV format supplied by Peregrine Semiconductor that has optimized the PE44820 at a particular frequency inside or outside the 1.7–2.2 GHz range. For example, the file “PE44820\_LookupTable\_OptPhase\_1700-2200MHz.csv” is included with the DPS evaluation software which optimizes the PE44820’s performance for minimum phase error across the band of operation. Additionally, the following files are provided:

- PE44820\_LookupTable\_OptPhase\_1575MHz.csv
- PE44820\_LookupTable\_OptPhase\_2400MHz.csv
- PE44820\_LookupTable\_OptPhase\_2600MHz.csv

Each of these files optimizes the PE44820’s performance for narrow band operation in the frequency defined in the filename. Other custom lookup tables can be provided for specific customer applications by Peregrine Semiconductor.

**Figure 27 • Lookup Table**

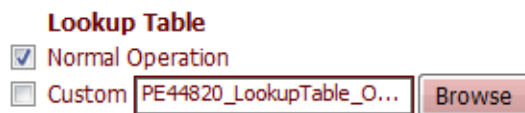

### Phase Shifter Graphic

The Phase Shifter graphic (**Figure 28**) displays the active sections of the phase shifter at any given time. This allows the user to observe the effect of the lookup tables on the control and operation of the phase shifter. Active phase shift sections have a red background.

**Figure 28 • Phase Shifter Graphic**

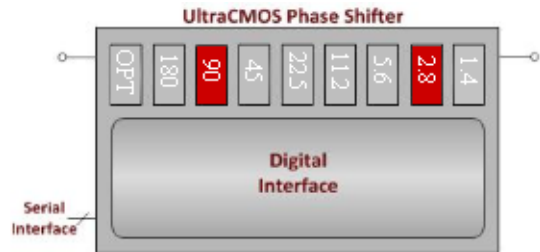

## Help

The DPS software contains a help section with information on using the evaluation software via a command line interface to aid in the evaluation of the phase shifter. To access the command line help, click Help on the menu bar item, then click on Command Line (see **Figure 29**).

**Figure 29 • Command Line Control**

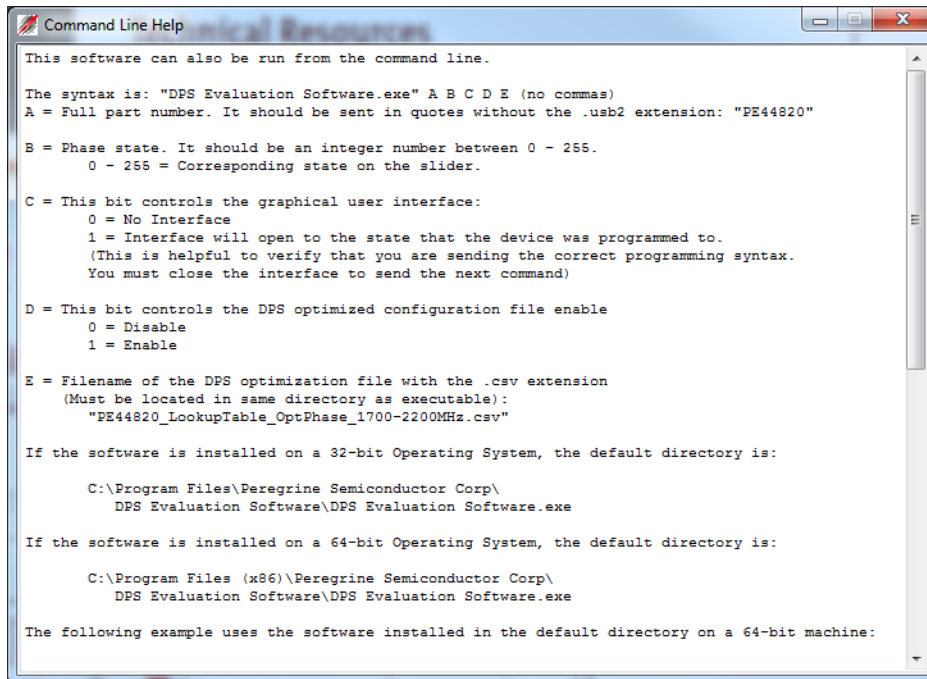

The DPS software also contains a help section with the board outline image containing the jumper and switch control descriptions to aid in the configuration and evaluation of the phase shifter. To access the help image, click Help on the menu bar item, then click on Board Connections (see **Figure 30**).

**Figure 30 • Board Connections**

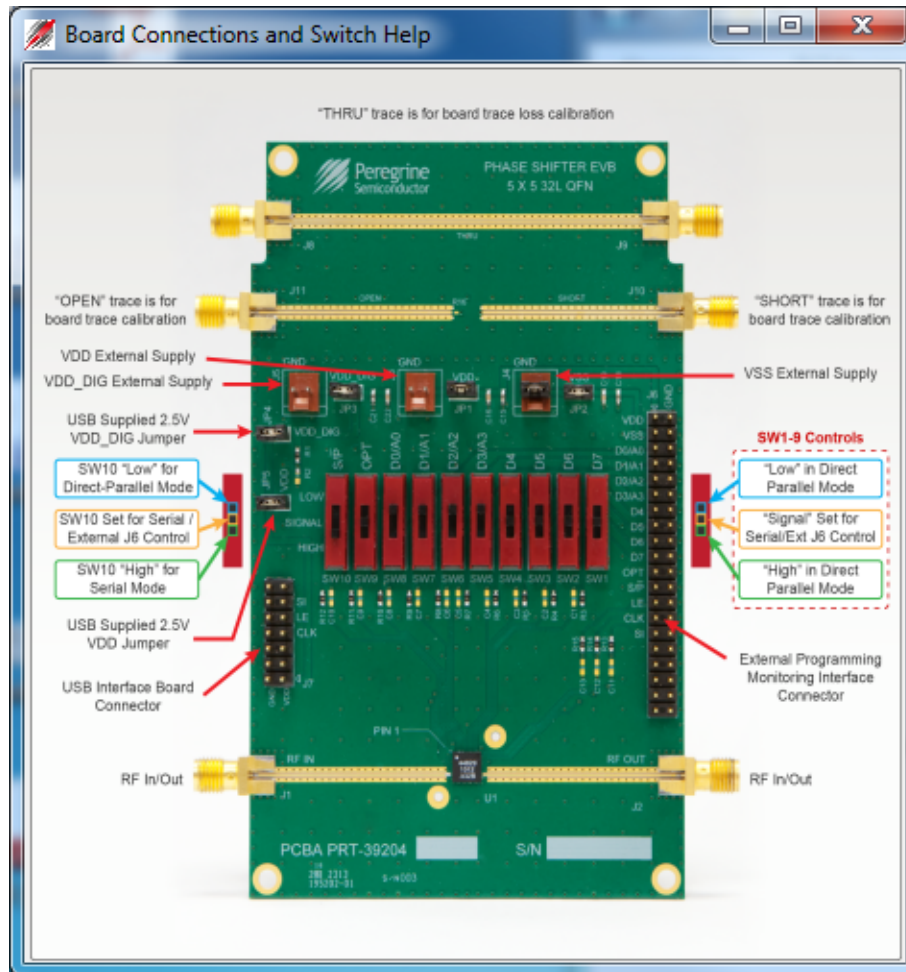

# Technical Resources



## Technical Resources

Additional technical resources are available for download in the Products section at [www.psemi.com](http://www.psemi.com). These include the Product Specification datasheet, S-parameters, zip file, evaluation kit schematic and bill of materials, material declaration form and PC-compatible software file.

Trademarks are subject to trademark claims.

This page intentionally left blank.



# Document Categories

## Advance Information

The product is in a formative or design stage. The document contains design target specifications for product development. Specifications and features may change in any manner without notice.

## Preliminary Specification

The document contains preliminary data. Additional data may be added at a later date. Peregrine reserves the right to change specifications at any time without notice in order to supply the best possible product.

## Product Specification

The document contains final data. In the event Peregrine decides to change the specifications, Peregrine will notify customers of the intended changes by issuing a CNF (Customer Notification Form).

## Not Recommended for New Designs (NRND)

This product is in production but is not recommended for new designs.

## End of Life (EOL)

This product is currently going through the EOL process. It has a specific last-time buy date.

## Obsolete

This product is discontinued. Orders are no longer accepted for this product.