

## Liquid Level Sensor for Mounting Pipe (Through-Beam)

### ■ Features

- Detects liquid in a transparent/semitransparent pipe diameter  $\varnothing 6$  to 13mm, thickness 1mm
- Compact size: W23×H14×L13mm
- Selectable Light ON/Dark ON operation mode by operation mode switching button
- Easy to check operation status by operation mode indicator [green LED (Light ON: on, Dark ON: off)], operation indicator [red LED]
- Built-in reverse polarity protection circuit and output short overcurrent protection circuit
- IP64 of protection structure (IEC standards)



**⚠ Please read "Safety Considerations" in the instruction manual before using.**



### ■ Model

Model	Pipe diameter	Sensing type	Power supply	Control output
BL13-TDT	$\varnothing 6$ to 13mm	Through-beam	12-24VDC $\pm 10\%$	NPN open collector output
BL13-TDT-P				PNP open collector output

### ■ Specifications

Model	NPN open collector output	BL13-TDT
	PNP open collector output	BL13-TDT-P
Sensing type	Through-beam	
Applicable pipe	<ul style="list-style-type: none"> <li>•Using binding band: <math>\varnothing 6</math> to 13mm</li> <li>•Using protection bracket: <math>\varnothing 12.7</math>mm (1/2 inch) transparent pipes in 1mm thickness (FEP (fluoroplastic) or with equivalent transparency)</li> </ul>	
Standard sensing target	Liquid in a pipe <sup>※1</sup>	
Response time	Max. 2ms	
Power supply	12-24VDC $\pm 10\%$ (ripple P-P: max. 10%)	
Current consumption	Max. 30mA	
Light source	Infrared LED (950nm)	
Operation mode	Light ON/Dark ON operation mode switch button	
Control output	NPN or PNP open collector output <ul style="list-style-type: none"> <li>•Load voltage: max. 30VDC</li> <li>•Load current: max. 100mA</li> <li>•Residual voltage: max. 1VDC</li> </ul>	
Protection circuit	Reverse polarity protection circuit, output short overcurrent protection circuit	
Indicator	Operation indicator: red LED, operation mode indicator: green LED	
Insulation resistance	Over 20M $\Omega$ (at 500VDC megger)	
Noise immunity	$\pm 240$ V the square wave noise (pulse width: 1 $\mu$ s) by the noise simulator	
Dielectric strength	1,000VAC 50/60Hz for 1 minute (between all terminals and case)	
Vibration	1.5mm amplitude or 300m/s <sup>2</sup> at frequency of 10 to 55Hz in each of X, Y, Z direction for 2 hours	
Shock	500m/s <sup>2</sup> (approx. 50G) in each X, Y, Z direction for 3 times	
Environment	Ambient illumination	Sunlight/incandescent lamp: max. 3,000lx for each (receiver illumination)
	Ambient temperature	10 to 55°C, storage: -25 to 65°C
	Ambient humidity	35 to 85%RH, storage: 35 to 85%RH
Protection structure	IP64 (IEC standard)	
Material	Case: polycarbonate	
Cable	$\varnothing 2.5$ , 3-wire, 1m (AWG28, core diameter: 0.08mm, number of cores: 19, insulator diameter: $\varnothing 0.9$ )	
Accessory	Binding band: 2, anti-slip tube: 2	
Approval	CE	
Weight <sup>※2</sup>	Approx. 50g (approx. 13g)	

※1: This may not detect the liquid with low transparent, with high viscosity, or with floating matters.

※2: The weight includes packaging. The weight in parenthesis is for unit only.

※The temperature or humidity mentioned in Environment indicates a non freezing or condensation environment.

# Liquid Level Sensor

## Operation Mode

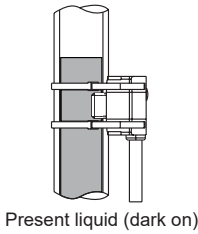
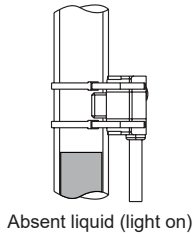

Operation mode	Light ON
Receiver operation	Received light  Interrupted light
Operation indicator (red LED)	ON  OFF
Transistor output	ON  OFF

Operation mode	Dark ON
Receiver operation	Received light  Interrupted light
Operation indicator (red LED)	ON  OFF
Transistor output	ON  OFF

## Operating Timing Diagram

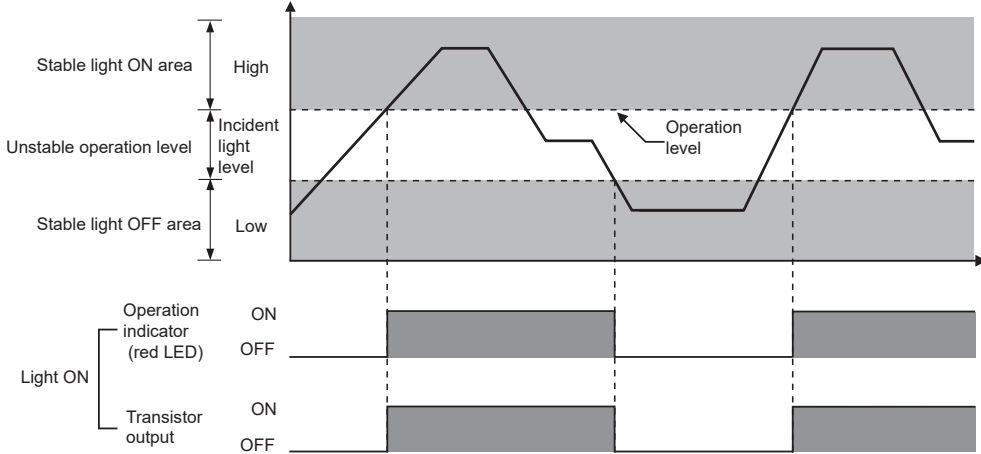

※The waveforms of 'Operation indicator' and 'Transistor output' are for Light ON, it is operated as reverse in Dark ON.

## Control Output Circuit Diagram

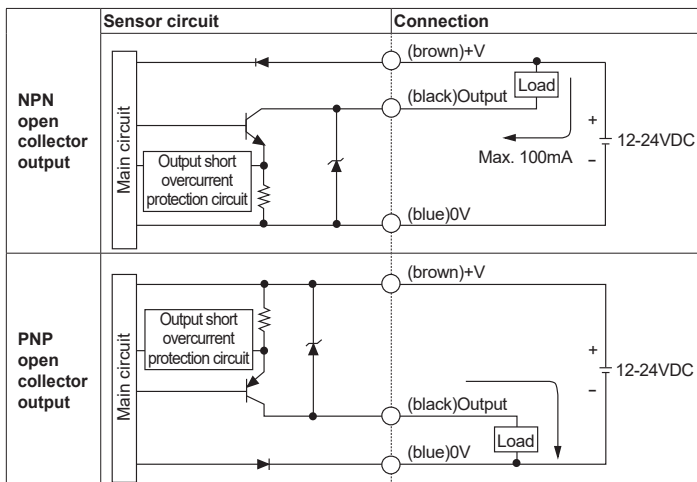

※If short-circuit the control output terminal or supply current over the rated specification, normal control signal is not output due to the output short over current protection circuit.

## Connection

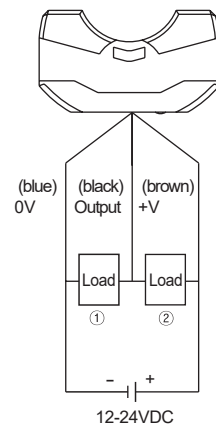

① Load connection for PNP output  
② Load connection for NPN output

SENSORS

CONTROLLERS

MOTION DEVICES

SOFTWARE

(A) Photoelectric Sensors

(B) Fiber Optic Sensors

(C) LIDAR

(D) Door/Area Sensors

(E) Vision Sensors

(F) Proximity Sensors

(G) Pressure Sensors

(H) Rotary Encoders

(I) Connectors/ Connector Cables/ Sensor Distribution Boxes/ Sockets

# BL Series

## Dimensions

(unit: mm)

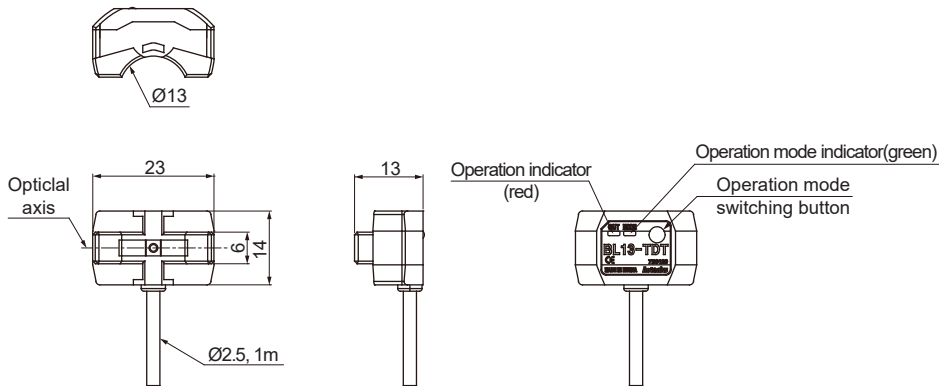

◎ Protection bracket (BK-BL13-P(sold separately))

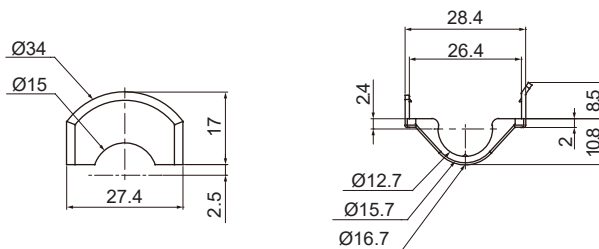

※For using the protection bracket, only Ø12.7mm (1/2 inch) pipes are available.

## Installation

If installing this unit at opaque pipes, it is impossible to detect accurately. Install this unit at the rated pipes.  
Using binding band: Ø6 to 13mm, Using protection bracket: Ø12.7mm (1/2 inch)

- If installing this unit at an opaque pipe, it is impossible to detect accurately. Install this unit at the rated pipe.
- Fix a pipe and this sensor tightly with binding bands and anti-slip tubes as the below figure and cut the spare part of binding bands with scissors or a knife.
- When connecting binding bands, be careful not to transform a pipe.

◎ Protection bracket (sold separately)

Choose a location on the pipe and attach the sensor and the protection bracket.

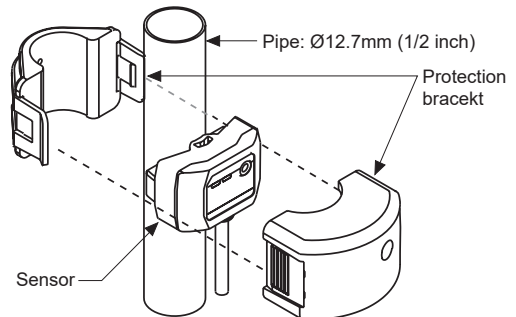
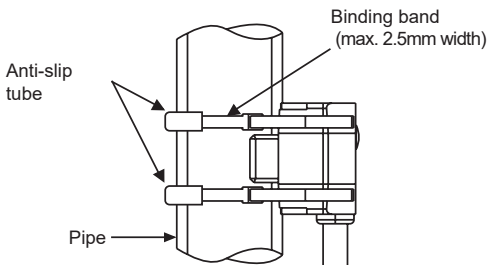

※Principle of operation

It detects whether there is liquid or not in a pipe by refractive index of light.

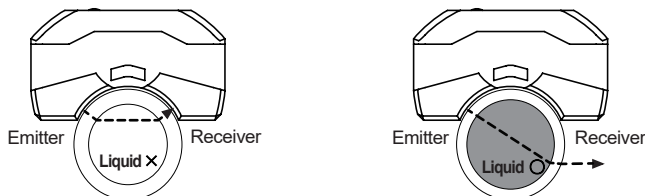

## ■ Functions

### ● Operation mode switching

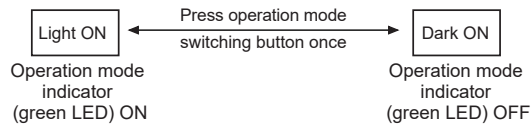
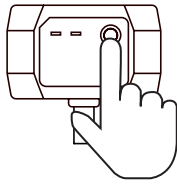

### ● Operation mode lock setting

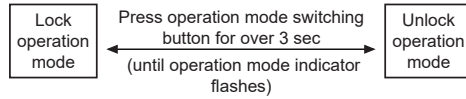
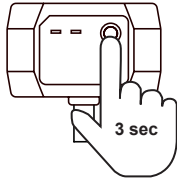

※If you press the operation mode switching button (less than 3 sec) in lock operation status and the operation mode indicator (green LED) flashes 3 times.

SENSORS

CONTROLLERS

MOTION DEVICES

SOFTWARE

(A) Photoelectric Sensors

(B) Fiber Optic Sensors

(C) LiDAR

(D) Door/Area Sensors

(E) Vision Sensors

(F) Proximity Sensors

(G) Pressure Sensors

(H) Rotary Encoders

(I) Connectors/  
Connector Cables/  
Sensor Distribution  
Boxes/ Sockets