

Data sheet | Item number: 890-122

Socket; with strain relief housing; 2-pole; Cod. A; 1,50 mm²; white

www.wago.com/890-122

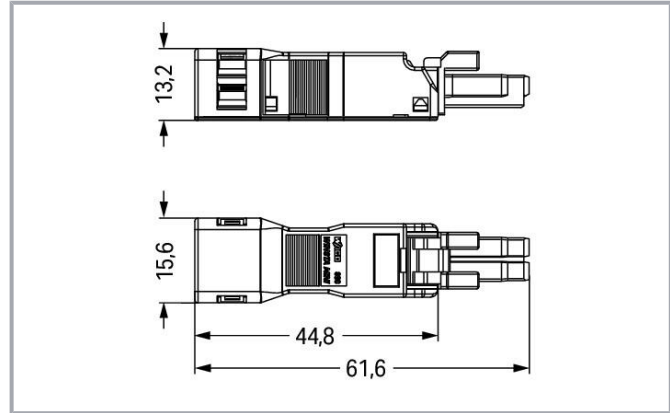
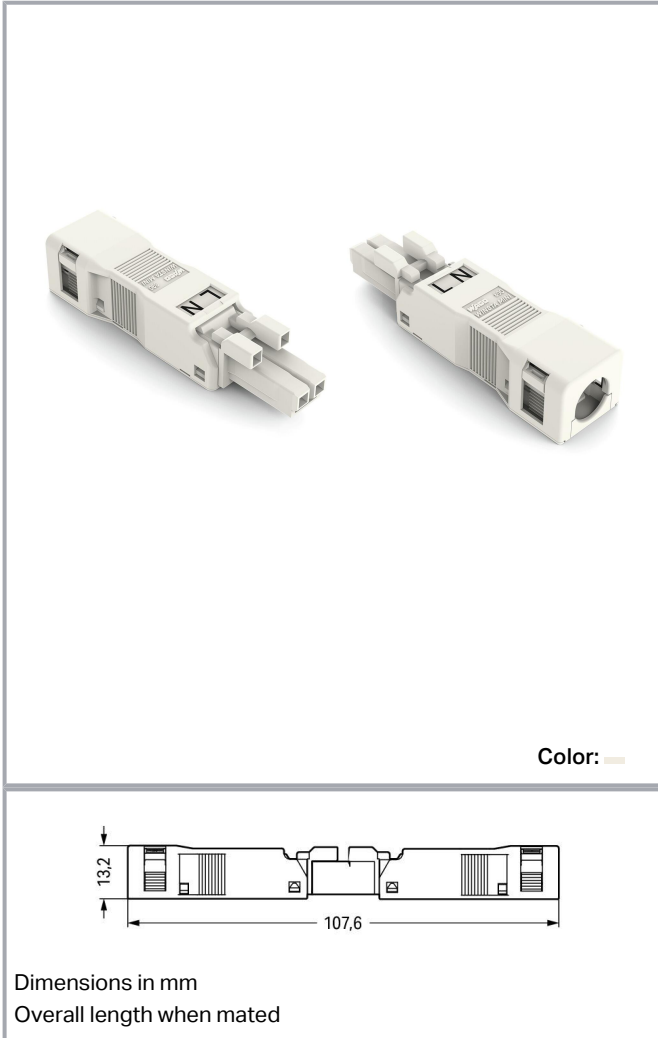

Item description

Female connector/socket WINSTA® MINI with protection type IP40

The WINSTA® MINI female connector/socket 2-pole supports rapid, correct installation. Our pluggable installation connectors with spring pressure connection technology function without screw connections. They allow resource-efficient, error-free installation in a large number of applications.

Subject to changes. Please also observe the further product documentation!

WAGO GmbH & Co. KG
Hansastr. 27
32423 Minden
Phone: +49571 887-0 | Fax: +49571 887-169
Email: info.de@wago.com | Web: www.wago.com

Do you have any questions about our products?
We are always happy to take your call at +49 (571) 887-44222.



The mechanical coding and color coding of the pluggable installation connector ensure error-free installation of the individual components – including protection against mismatching. The pluggable installation connector is protected against ingress by solid granular objects with a diameter of less than 1 mm in accordance with protection type IP40. The *WINSTA*® MINI pluggable installation connector with A coding in white or black is normally used for general mains applications in power distribution. Thanks to its particularly minimal dimensions, our *WINSTA*® MINI Pluggable Connection System with Push-in CAGE CLAMP® spring pressure connection technology is specifically suitable in very restricted spaces, i.e., for connections when very little room is available. A range up to 32 mm can be used for the strip length.

WINSTA® MINI solutions for your electrical installation – protected against mismatching and maintenance-free

The *WINSTA*® Pluggable Connection System is ideally tailored to the strict requirements of building installation. It makes electrical installation pluggable, and thus more efficient, even more reliable, and error-free. Using this pre-assembled system decreases time spent on assembly and errors during installation at the construction site. Take advantage of the pluggable version of our maintenance-free spring pressure connection technology too! Plan your installation with *WINSTA*® MINI pluggable installation connectors with protection type IP40 from WAGO.

- protection against mismatching eliminates errors
- easy tool-free operation, a wide range of coding options
- for any mains application
- custom-engineered solutions
- convenient installation and commissioning

Data

Electrical data

Ratings per IEC/EN

Ratings per	IEC/EN 60664-1
Nominal voltage (III/3)	250 V
Rated impulse voltage (III/3)	4 kV
Rated current	16 A
Legend (ratings)	(III / 3) ≙ Overvoltage category III / Pollution degree 3

Ratings per UL 1977

Note for the US market	Some versions may also be used for current interruption in accordance with the UL certificate in select applications with currents below 5 A and voltages up to 600 V. For further information, please contact your local sales office.
Rated voltage (UL 1977)	600 V
Rated current UL 1977	14 A

Subject to changes. Please also observe the further product documentation!



General

Note on contact resistance	approx. 1 mΩ of contact resistance approx. 0.25 mΩ contact transition plug/socket
----------------------------	--

Connection data

Connection points	2
Total number of potentials	2

Connection 1

Connection technology	Push-in CAGE CLAMP®
Actuation type	Operating tool Push-in
Nominal cross-section	1.5 mm ² / 16 AWG
Solid conductor	0.25 ... 1.5 mm ² / 22 ... 16 AWG
Solid conductor; push-in termination	0.75 ... 1.5 mm ² / 20 ... 16 AWG
Stranded conductor	0.25 ... 1 mm ² / 22 ... 18 AWG
Fine-stranded conductor	0.25 ... 1.5 mm ² / 22 ... 16 AWG
Fine-stranded conductor; with insulated ferrule	0.25 ... 0.75 mm ² / 22 ... 20 AWG
Fine-stranded conductor; with uninsulated ferrule	0.25 ... 0.75 mm ² / 22 ... 20 AWG
Fine-stranded conductor; with ferrule; push-in termination	0.75 mm ² / 20 AWG
Strip length	9 mm / 0.35 inches
Pole number	2
Conductor entry direction to mating direction	0°
Strip length (outer insulation)	32 mm

Physical data

Pin spacing	4.4 mm / 0.173 inches
Width	15.6 mm / 0.614 inches
Height	13.2 mm / 0.52 inches
Depth	61.6 mm / 2.425 inches

Mechanical Data

Application	General mains applications
Coding	A
Variable coding	No
Marking	L N

Subject to changes. Please also observe the further product documentation!



Potential marking	L N
Mating force of a plug-in connection	approx. 20 ... 70 N (depending on pole number)
Retention force of a plug-in connection	Locked: > 80 N
Unmating force of a plug-in connection	Unlocked: approx. 20 ... 70 N (depending on pole number)
Number of mating cycles	200, without resistive load
Protection type	IP40

Plug-in connection

Contact type (pluggable connector)	Female connector/socket
Connector (connection type)	for conductor
Mismating protection	Yes
Note on mismating protection	All <i>WINSTA</i> [®] components are 100% protected against mismating when: a.) plugging different numbers of poles b.) plugging while rotated 180 c.) plugging while laterally staggered d.) plugging one pole
Locking lever	Can be retrofitted
Locking of plug-in connection	locking lever
Note on locking system	All connectors for mounted installations (snap-in versions for lighting fixtures or devices, all types of PCB and distribution connectors) are factory-equipped with locking levers to ensure plugs and sockets are securely locked. Additional locking levers are only required for flying leads (plug/socket).
Strain relief	strain relief housing

Material Data

Note (material data)	Information on material specifications can be found here
Color	white
Cover color	gray
Material group	I
Insulation material	Polyamide (PA66)
Flammability class per UL94	V0
Clamping spring material	Chrome-nickel spring steel (CrNi)
Contact material	Copper or copper alloy; surface-treated
Contact plating	Tin
Fire load	0.152 MJ

Subject to changes. Please also observe the further product documentation!

Weight	5.6 g
--------	-------

Environmental requirements

Processing temperature	-5 ... +40 °C
Continuous operating temperature	-35 ... +85 °C
Note on continuous operating temperature	Insulating parts for temperatures ≤ 105 °C

Commercial data



Product Group	20 (Winsta)
eCl@ss 10.0	27-44-06-05
eCl@ss 9.0	27-44-06-05
ETIM 8.0	EC002560
ETIM 7.0	EC002560
PU (SPU)	50 pcs
Packaging type	box
Country of origin	DE
GTIN	4045454232955
Customs tariff number	85366990990

Environmental Product Compliance

RoHS Compliance Status	Compliant, No Exemption
------------------------	-------------------------

Approvals / Certificates

General approvals

Logo	Approval	Additional Approval Text	Certificate name
	CCA DEKRA Certification B.V.	EN 61535	71- 123231
	CCA DEKRA Certification B.V.	IEC 61535	NL-85020
	cURus Underwriters Laboratories Inc.	UL 1977	E45171



Declarations of conformity and manufacturer's declarations

Certificate



Subject to changes. Please also observe the further product documentation!

WAGO GmbH & Co. KG
 Hansastr. 27
 32423 Minden
 Phone: +49571 887-0 | Fax: +49571 887-169
 Email: info.de@wago.com | Web: www.wago.com



Do you have any questions about our products?
 We are always happy to take your call at +49 (571) 887-44222.

Logo	Approval	Additional Approval Text	name
	EU-Declaration of Conformity WAGO GmbH & Co. KG	-	-
	UK-Declaration of Conformity WAGO GmbH & Co. KG	-	-

Approvals for marine applications

Logo	Approval	Additional Approval Text	Certificate name
	ABS American Bureau of Shipping	Steel Vessel Rules	19- HG1869855- PDA
	DNV GL Det Norske Veritas, Germanischer Lloyd	-	TAE00001Z6
	LR Lloyds Register	EN 61535	08/20047 (E2)

Counterpart

	Item no.890-132 Plug; with strain relief housing; 2-pole; 1,50 mm ² ; white	www.wago.com/890-132
	Item no.890-1656 T-distribution connector; 2-pole; Cod. A; 1 input; 2 outputs; 2 locking levers; white	www.wago.com/890-1656
	Item no.890-1665 T-distribution connector; 2-pole; Cod. A; 1 input; 2 outputs; 3 locking levers; for flying leads; white	www.wago.com/890-1665

Item no.890-1686

Subject to changes. Please also observe the further product documentation!



h-distribution connector; 2-pole; Cod. A; 1 input; 2 outputs; outputs on one side; 3 locking levers; for flying leads; white www.wago.com/890-1686



Item no.890-232
Plug; 2-pole; 1,50 mm²; white www.wago.com/890-232



Item no.890-1684
h-distribution connector; 2-pole; Cod. A; 1 input; 2 outputs; outputs on one side; 2 locking levers; white www.wago.com/890-1684



Item no.890-732
Snap-in plug; 2-pole; Cod. A; 1,50 mm²; white www.wago.com/890-732



Item no.890-832
Plug for PCBs; straight; 2-pole; Cod. A; white www.wago.com/890-832



Item no.890-832/011-000
Plug for PCBs; angled; 2-pole; Cod. A; white www.wago.com/890-832/011-000



Item no.891-8992/005-102
pre-assembled interconnecting cable; Eca; Socket/plug; 2-pole; Cod. A; H05VV-F 2 x 1.0 mm²; 1 m; 1,00 mm²; white www.wago.com/891-8992/005-102



Item no.891-8992/205-102
pre-assembled connecting cable; Eca; Plug/open-ended; 2-pole; Cod. A; H05VV-F 2 x 1.0 mm²; 1 m; 1,00 mm²; white www.wago.com/891-8992/205-102

Required accessories

Locking levers

Locking system



Item no.: 890-111
Locking lever; for flying leads; for tool operation; black www.wago.com/890-111



Item no.: 890-101
Locking lever; for manual operation; black www.wago.com/890-101



Item no.: 890-121
Locking lever; for manual operation; white www.wago.com/890-121

Subject to changes. Please also observe the further product documentation!



Item no.: 890-131

Locking lever; for flying leads; for tool operation; white

www.wago.com/890-131

Optional accessories

Cover

Cover



Item no.: 897-2001

Protective cap; Type1; for sockets and plugs; PVC; red

www.wago.com/897-2001

Tool

Operating tool



Item no.: 210-719

Operating tool; Blade: 2.5 x 0.4 mm; with a partially insulated shaft

www.wago.com/210-719



Item no.: 890-382

Operating tool; 2-way; green

www.wago.com/890-382

Mounting

Mounting accessories



Item no.: 890-310

Mounting carrier; 2- to 5-pole; for flying leads; black

www.wago.com/890-310



Item no.: 890-311

Mounting carrier; 2- to 5-pole; for flying leads; white

www.wago.com/890-311

Downloads

Documentation

Bid Text

890-122 X81 - Datei	2019 Feb 19	xml 3.1 kB	Download
890-122 doc - Datei	2018 Nov 29	doc 24.1 kB	Download

Subject to changes. Please also observe the further product documentation!

CAD/CAE-Data

CAE data

EPLAN Data Portal 890-122	URL	Download
WSCAD Universe 890-122	URL	Download
ZUKEN Portal 890-122	URL	Download

CAD data

2D/3D Models 890-122	URL	Download
----------------------	---------------------	--------------------------

Environmental Product Compliance

Compliance Search

Environmental Product Compliance 890-122	URL	Download
Socket; with strain relief housing; 2-pole; Cod. A; 1,50 mm ² ; white		

Installation Notes

Conductor termination

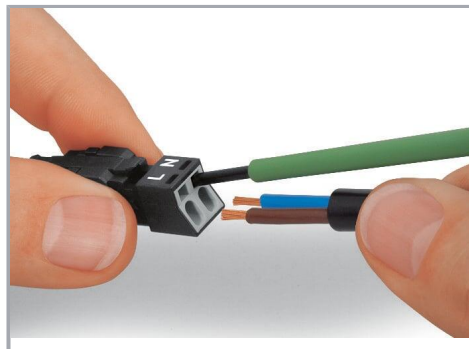
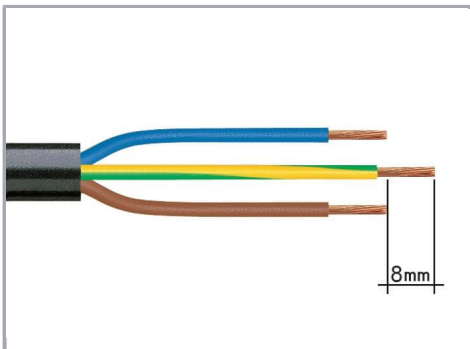

1. Strip length, outer insulation = 30 mm (2-pole), 37 mm (3-pole), 45 mm (4- and 5-pole)
2. Strip length = 9 mm
3. Extended ground conductor = 8 mm

To terminate fine-stranded conductors, open the clamping unit via screwdriver – 2.5 mm blade width – and insert a stripped conductor until it hits the backstop.
Terminate solid conductors by simply pushing them in.

Subject to changes. Please also observe the further product documentation!

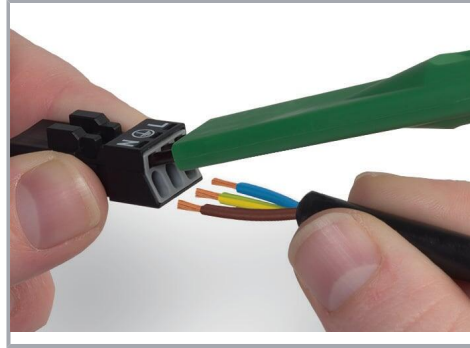
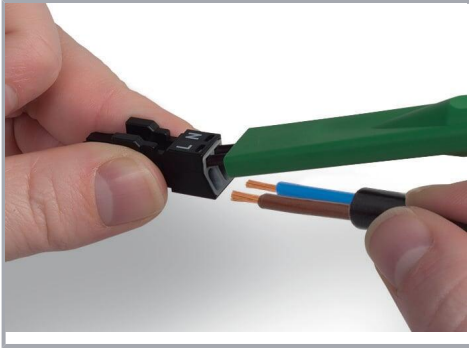

To terminate fine-stranded conductors, open clamping units via operating tool (890-382) and insert stripped conductors until they hit backstop.

To terminate fine-stranded conductors, open clamping units via operating tool (890-383) and insert stripped conductors until they hit backstop.

Terminate solid conductors by simply pushing them in.

Terminate solid conductors by simply pushing them in.

Installation

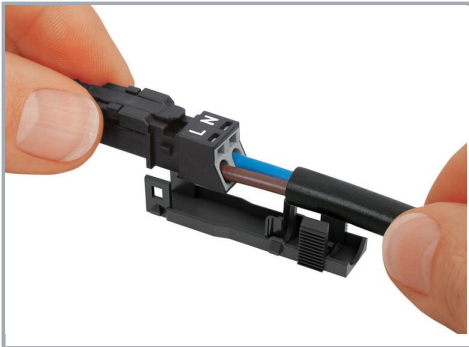

Latch the wired connector into the base of the strain relief housing.

Push down strain relief clamp by hand.

Subject to changes. Please also observe the further product documentation!



Push down strain relief clamp with 2.5 mm screwdriver alternately on both sides.

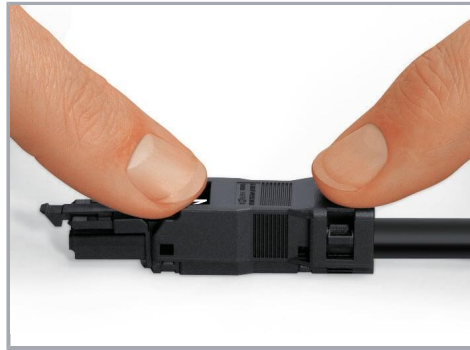

Latch the top of the strain relief housing.



The printed marking of the connector is clearly visible in the openings of the strain relief housing.

Product family

WINSTA® MINI

[Show all products from the family](#)

Subject to changes. Please also observe the further product documentation!