

Contact Code

540-Wire Wrap (w/ Wire Hole) .060x.025(1.52x0.64) - Tail
 LG.=.774(18.90)

THIS IS A C.A.D. GENERATED DRAWING
 DO NOT MAKE MANUAL REVISIONS TO MASTER



ISSUE NUMBER

ORIGINAL

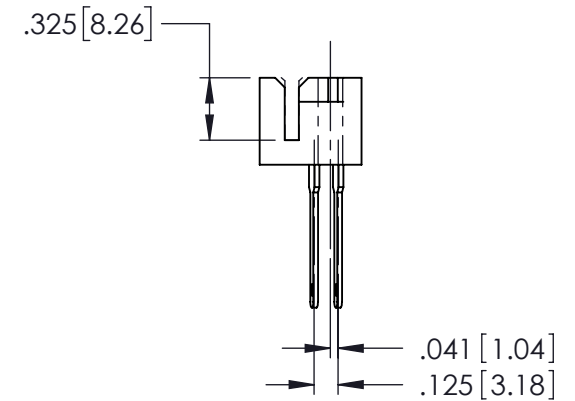
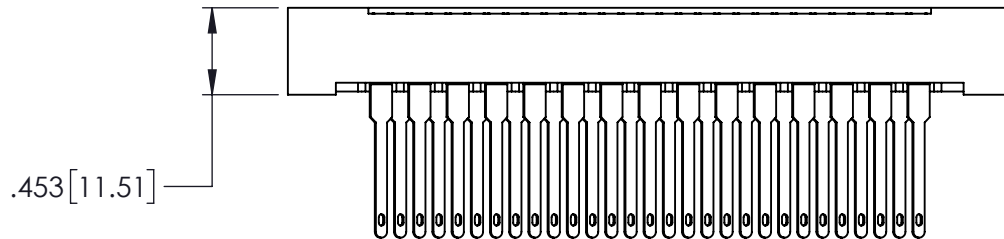
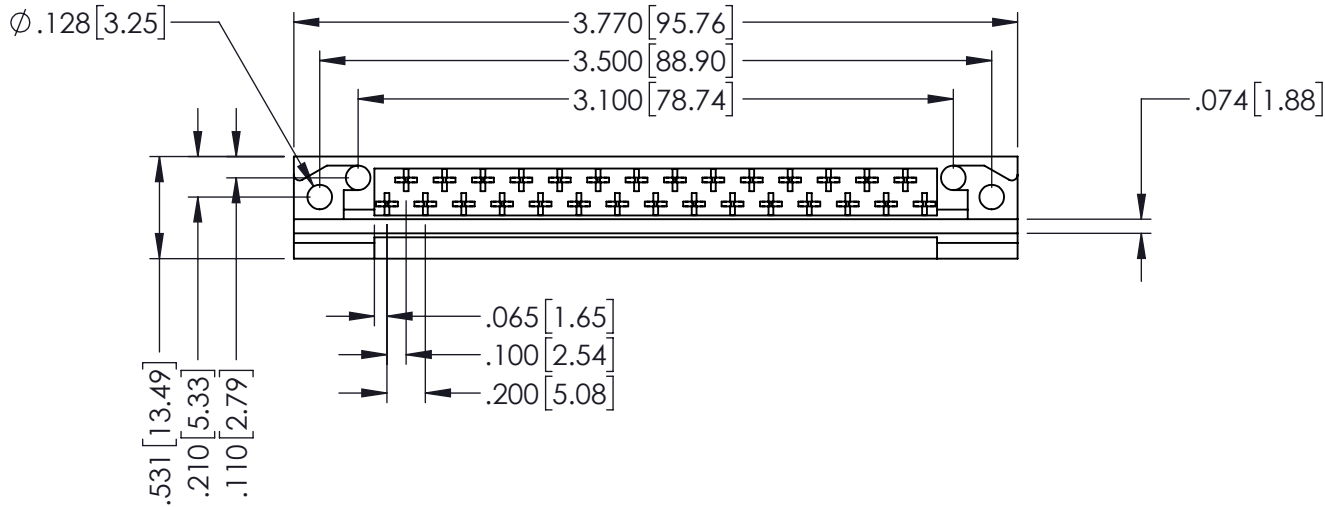

408/424 Series High Reliability Interlock Connector
 PART NUMBER: 424-029-540-112

ACAD REFERENCE NO. 408-ENG-MASTER

DRAWN: J.LEE DATE: SEPT. 16/09

CHECKED: DATE:

SCALE: NTS SHEET 1 OF 1

DRAWING NUMBER 408-ENG-MASTER ISSUE 1



EDAC INC
 TORONTO, ONTARIO
 CANADA

YOUR CONNECTION TO QUALITY & SERVICE

THESE DRAWINGS AND SPECIFICATIONS
 ARE THE PROPERTY OF EDAC INC. AND
 SHALL NOT BE REPRODUCED, OR COPIED
 OR USED AS THE BASIS FOR THE
 MANUFACTURE OR SALE OF APPARATUS
 WITHOUT WRITTEN PERMISSION.