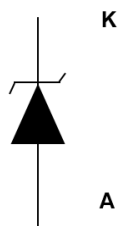
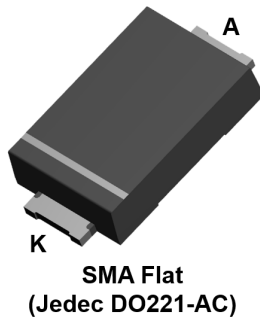



## Automotive 600 W TVS in SMA Flat



Unidirectional

## Features

- AEC-Q101 qualified 
- Peak pulse power: 600 W (10/1000  $\mu$ s) and 4 kW (8/20  $\mu$ s)
- Flat and thin package: 1 mm
- Stand-off voltage range from 5 V to 188 V
- Unidirectional type
- Low leakage current: 0.2  $\mu$ A at 25 °C and 1  $\mu$ A at 85 °C
- Operating  $T_j$  max: 175 °C
- High power capability at  $T_j$  max.: up to 400 W (10/1000  $\mu$ s)
- Lead finishing: matte tin plating

## Complies with the following standards

- UL94, V0
- J-STD-020 MSL level 1
- J-STD-002, JESD 22-B102 E3 and MIL-STD-750, method 2026
- JESD-201 class 2 whisker test
- IPC7531 footprint and JEDEC registered package outline
- IEC 61000-4-4 level 4:
  - 4 kV
- ISO10605, IEC 61000-4-2, C = 150 pF - R = 330  $\Omega$  exceeds level 4:
  - 30 kV (contact discharge)
  - 30 kV (air discharge)
- ISO10605, C = 330 pF, R = 330  $\Omega$  exceeds level 4:
  - 30 kV (contact discharge)
  - 30 kV (air discharge)
- ISO7637-2 (Not applicable to parts with  $V_{RM}$  lower than battery voltage)
  - Pulse 1:  $V_S = -150$  V
  - Pulse 2a:  $V_S = +112$  V
  - Pulse 3a:  $V_S = -220$  V
  - Pulse 3b:  $V_S = +150$  V

## Description

The SMA6FY Transil series are designed to protect sensitive automotive circuits against surges defined in ISO 7637 series and against electrostatic discharges according to ISO 10605.

The Planar technology makes it compatible with high-end circuits where low leakage current and high junction temperature are required to provide long term reliability and stability.

Product status link	
SMA6FY	<a href="#">SMA6F5.0AY</a> , <a href="#">SMA6F6.0AY</a> , <a href="#">SMA6F6.5AY</a> , <a href="#">SMA6F8.5AY</a> , <a href="#">SMA6F10AY</a> , <a href="#">SMA6F11AY</a> , <a href="#">SMA6F12AY</a> , <a href="#">SMA6F13AY</a> , <a href="#">SMA6F14AY</a> , <a href="#">SMA6F15AY</a> , <a href="#">SMA6F16AY</a> , <a href="#">SMA6F18AY</a> , <a href="#">SMA6F20AY</a> , <a href="#">SMA6F22AY</a> , <a href="#">SMA6F23AY</a> , <a href="#">SMA6F24AY</a> , <a href="#">SMA6F26AY</a> , <a href="#">SMA6F28AY</a> , <a href="#">SMA6F30AY</a> , <a href="#">SMA6F31AY</a> , <a href="#">SMA6F33AY</a> , <a href="#">SMA6F36AY</a> , <a href="#">SMA6F40AY</a> , <a href="#">SMA6F48AY</a> , <a href="#">SMA6F58AY</a> , <a href="#">SMA6F64AY</a> , <a href="#">SMA6F70AY</a> , <a href="#">SMA6F85AY</a> , <a href="#">SMA6F100AY</a> , <a href="#">SMA6F130AY</a> , <a href="#">SMA6F154AY</a> , <a href="#">SMA6F170AY</a> , <a href="#">SMA6F188AY</a>

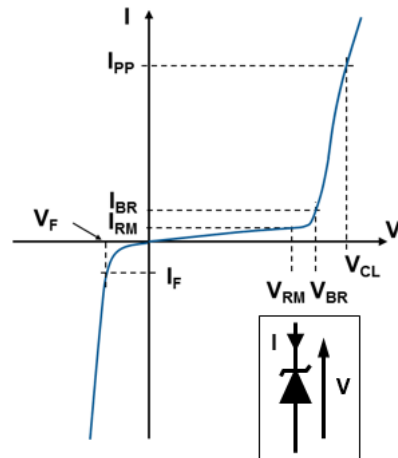
# 1 Characteristics

**Table 1. Absolute maximum ratings ( $T_{amb} = 25\text{ }^{\circ}\text{C}$ )**

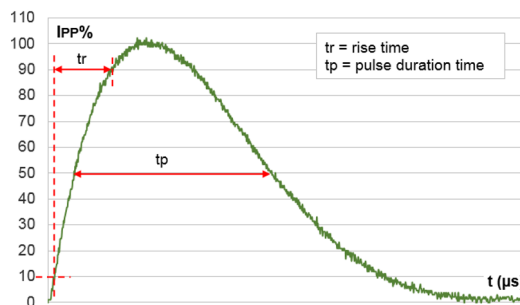
Symbol	Parameter	Value	Unit	
$V_{PP}$	Peak pulse voltage	ISO10605 ( $C = 330\text{ pF}$ , $R = 330\text{ }\Omega$ ):		
		Contact discharge	30	kV
		Air discharge	30	
		ISO10605 / IEC 61000-4-2 ( $C = 150\text{ pF}$ , $R = 330\text{ }\Omega$ )		
Contact discharge	30			
	Air discharge	30		
$P_{PP}$	Peak pulse power dissipation	10/1000 $\mu\text{s}$ , $T_j$ initial = $T_{amb}$	600	W
$T_{stg}$	Storage temperature range		-65 to +175	$^{\circ}\text{C}$
$T_j$	Operating junction temperature range		-55 to +175	$^{\circ}\text{C}$
$T_L$	Maximum lead temperature for soldering during 10 s		260	$^{\circ}\text{C}$

**Figure 1. Electrical characteristics - parameter definitions**

- $V_{RM}$  Maximum stand-off voltage
- $I_{RM}$  Maximum leakage current @  $V_{RM}$
- $V_R$  Stand-off voltage
- $I_R$  Leakage current @  $V_R$
- $V_{BR}$  Breakdown voltage @  $I_{BR}$
- $I_{BR}$  Breakdown current
- $V_{CL}$  Clamping voltage @  $I_{PP}$
- $I_{PP}$  Peak pulse current
- $R_D$  Dynamic resistance
- $V_F$  Forward voltage drop @  $I_F$
- $I_F$  Forward current
- $\alpha T$  Voltage temperature coefficient



**Figure 2. Pulse definition for electrical characteristics**



**Table 2. Electrical characteristics - parameter values ( $T_{amb} = 25\text{ }^{\circ}\text{C}$ , unless otherwise specified)**

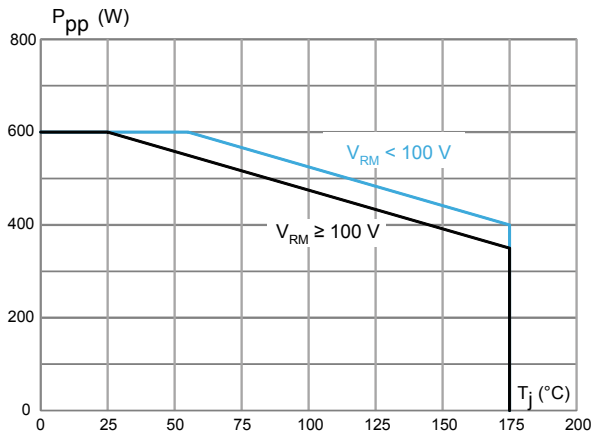
Type	$I_{RM}$ max at $V_{RM}$			$V_{BR}$ at $I_R$ <sup>(1)</sup>				10 / 1000 $\mu\text{s}$			8 / 20 $\mu\text{s}$			$\alpha T$
								$V_{CL}$ <sup>(2)(3)</sup>	$I_{PP}$ <sup>(4)</sup>	$R_D$	$V_{CL}$ <sup>(2)(3)</sup>	$I_{PP}$ <sup>(4)</sup>	$R_D$	
	25 $^{\circ}\text{C}$	85 $^{\circ}\text{C}$		Min.	Typ.	Max.		Max.		Max.	Max.	Max.	Max.	
	$\mu\text{A}$	V		V			mA	V	A	$\Omega$	V	A	$\Omega$	$10^{-4}/^{\circ}\text{C}$
SMA6F5.0AY	20	50	5.0	6.4	6.74	7.1	10	9.2	68	0.031	13.4	298	0.021	5.7
SMA6F6.0AY	20	50	6.0	6.7	7.05	7.4	10	10.3	61	0.048	13.7	290	0.022	5.9
SMA6F6.5AY	20	50	6.5	7.2	7.58	8	10	11.2	56	0.057	14.5	276	0.024	6.1
SMA6F8.5AY	20	50	8.5	9.4	9.9	10.4	1	14.4	41.7	0.096	19.5	205	0.044	7.3
SMA6F10AY	0.2	1	10	11.1	11.7	12.3	1	17	37	0.127	21.7	184	0.051	7.8
SMA6F11AY	0.2	1	11	12.3	13	13.7	1	18	33.8	0.127	24.2	165	0.064	8.1
SMA6F12AY	0.2	1	12	13.3	14	14.7	1	19.9	31	0.168	25.3	157	0.068	8.3
SMA6F13AY	0.2	1	13	14.4	15.2	16	1	21.5	29	0.190	27.2	147	0.076	8.4
SMA6F14AY	0.2	1	14	15.7	16.5	17.3	1	23.1	26	0.223	29	136	0.086	8.6
SMA6F15AY	0.2	1	15	16.7	17.6	18.5	1	24.4	25.1	0.235	32.5	123	0.114	8.8
SMA6F16AY	0.2	1	16	17.9	18.8	19.8	1	26	23.1	0.268	34.7	115	0.130	9.0
SMA6F18AY	0.2	1	18	20	21.1	22.2	1	29.2	21.5	0.326	39.3	102	0.168	9.2
SMA6F20AY	0.2	1	20	22.2	23.4	24.6	1	32.4	19.4	0.402	42.8	93	0.196	9.4
SMA6F22AY	0.2	1	22	24.4	25.7	27	1	35.5	17.7	0.480	48.3	83	0.257	9.6
SMA6F23AY	0.2	1	23	25.7	27	28.4	1	37.8	16.4	0.573	49.2	81	0.257	9.6
SMA6F24AY	0.2	1	24	26.7	28.1	29.5	1	38.9	16	0.588	50	80	0.256	9.6
SMA6F26AY	0.2	1	26	28.9	30.4	31.9	1	42.1	14.9	0.685	53.5	75	0.288	9.7
SMA6F28AY	0.2	1	28	31.1	32.7	34.3	1	45.4	13.8	0.804	59	68	0.363	9.8
SMA6F30AY	0.2	1	30	33.2	35	36.8	1	48.4	13	0.885	64.3	62	0.442	9.9
SMA6F31AY	0.2	1	31	34.2	36	37.8	1	50.2	12.3	1.01	65	61	0.45	9.9
SMA6F33AY	0.2	1	33	36.7	38.6	40.5	1	53.3	11.8	1.08	69.7	57	0.512	10
SMA6F36AY	0.2	1	36	40	42.1	44.2	1	58.1	10.3	1.35	76	52	0.612	10
SMA6F40AY	0.2	1	40	44.4	46.7	49	1	64.5	9.7	1.60	84	48	0.729	10.1
SMA6F48AY	0.2	1	48	53.2	56	58.8	1	77.4	8.1	2.28	100	40	1.03	10.3
SMA6F58AY	0.2	1	58	64.6	68	71.4	1	93.6	6.7	3.34	121	33	1.51	10.4
SMA6F64AY	0.2	1	64	71.1	74.8	78.6	1	103	5.8	4.17	134	30	1.84	10.5
SMA6F70AY	0.2	1	70	77.9	82	86.1	1	113	5.5	4.91	146	27	2.22	10.5
SMA6F85AY	0.2	1	85	95	100	105	1	137	4.6	7.17	178	22.5	3.29	10.6
SMA6F100AY	0.2	1	100	111	117	123	1	162	3.8	10.3	212	19	4.68	10.7
SMA6F130AY	0.2	1	130	144	152	160	1	209	3	16.3	265	15	7	10.8
SMA6F154AY	0.2	1	154	171	180	189	1	246	2.4	23.8	317	12.6	10.2	10.8
SMA6F170AY	0.2	1	170	190	200	210	1	275	2.2	30	353	11.3	12.7	10.8
SMA6F188AY	0.2	1	188	209	220	231	1	328	2	48.5	388	10.3	15.2	10.8

1. To calculate  $V_{BR}$  versus  $T_j$ :  $V_{BR}$  at  $T_j = V_{BR}$  at  $25\text{ }^{\circ}\text{C} \times (1 + \alpha T \times (T_j - 25))$
2. To calculate  $V_{CLmax}$  versus  $I_{PPappli}$ :  $V_{CLmax} = V_{BRmax} + R_D \times I_{PPappli}$
3. To calculate  $V_{CL}$  versus  $T_j$ :  $V_{CL}$  at  $T_j = V_{CL}$  at  $25\text{ }^{\circ}\text{C} \times (1 + \alpha T \times (T_j - 25))$

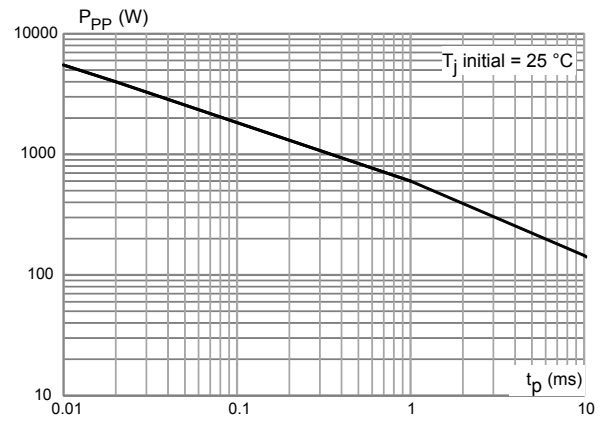
4. Surge capability given for both directions

**1.1 Characteristics (curves)**

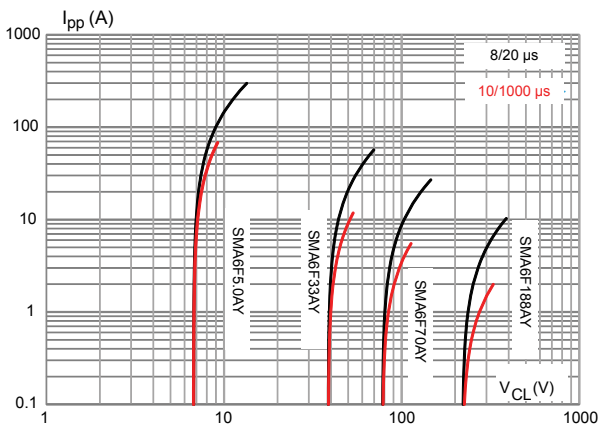
**Figure 3. Maximum peak power dissipation versus initial junction temperature**



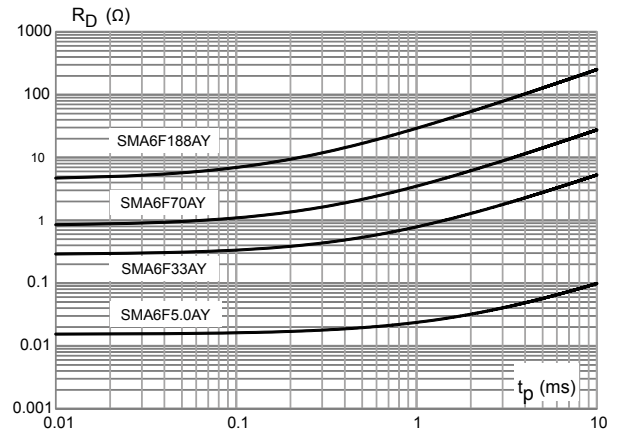
**Figure 4. Maximum peak pulse power versus exponential pulse duration**



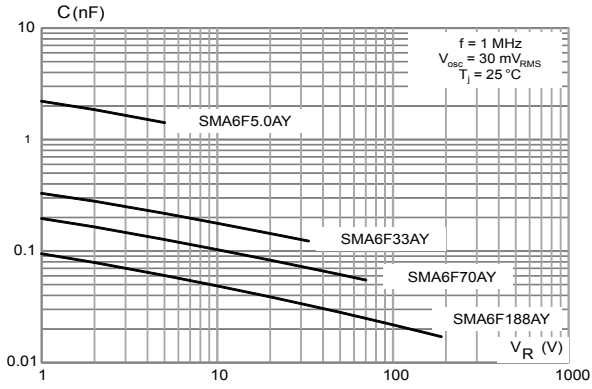
**Figure 5. Maximum clamping voltage versus peak pulse current**



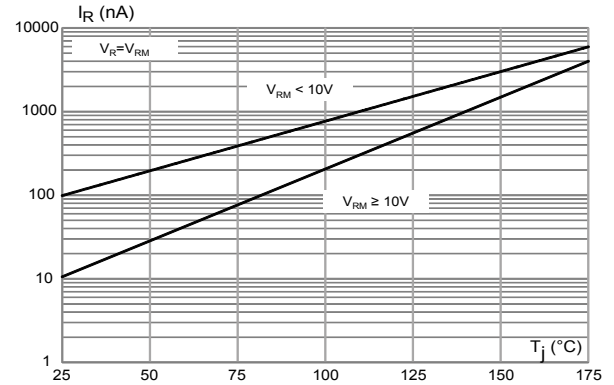
**Figure 6. Dynamic resistance versus pulse duration**



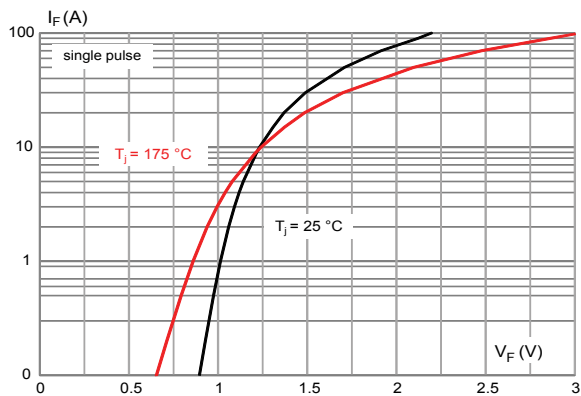
**Figure 7. Junction capacitance versus reverse applied voltage (unidirectional types)**



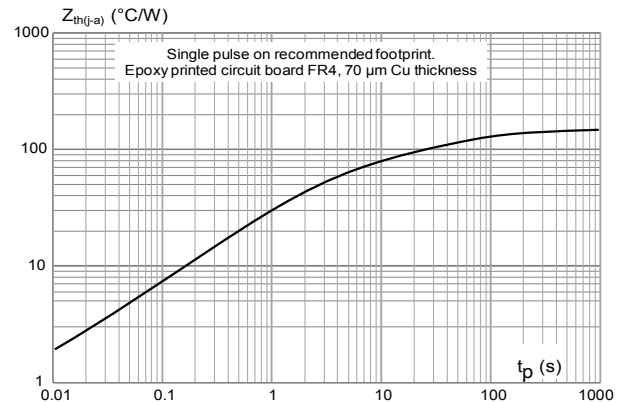
**Figure 8. Leakage current versus junction temperature**



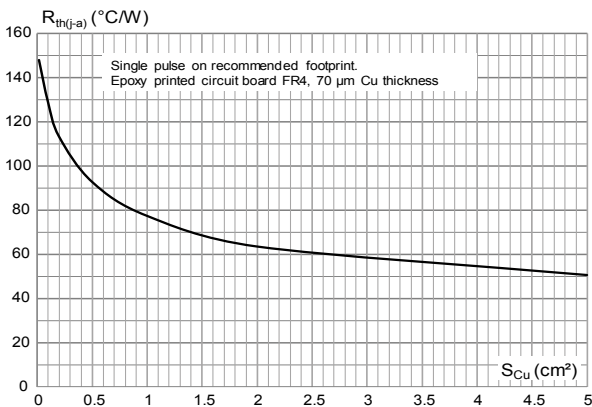
**Figure 9. Peak forward voltage drop versus peak forward current**



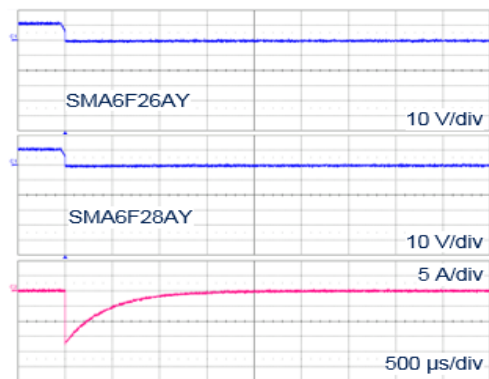
**Figure 10. Thermal impedance junction to ambient versus pulse duration**



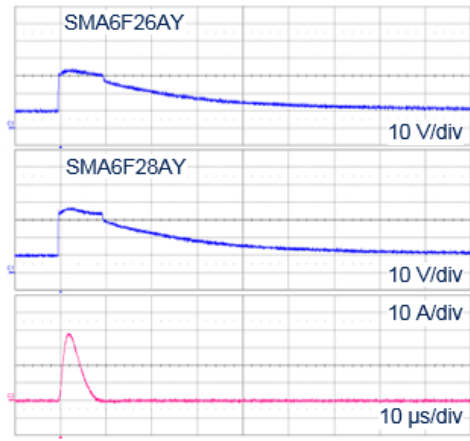
**Figure 11. Thermal resistance junction to ambient versus copper area under each lead**



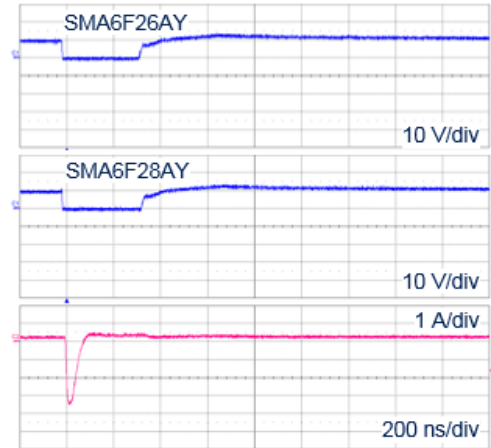
**Figure 12. ISO7637-2 pulse 1:  $V_s = -150 \text{ V}$  with 12 V battery**



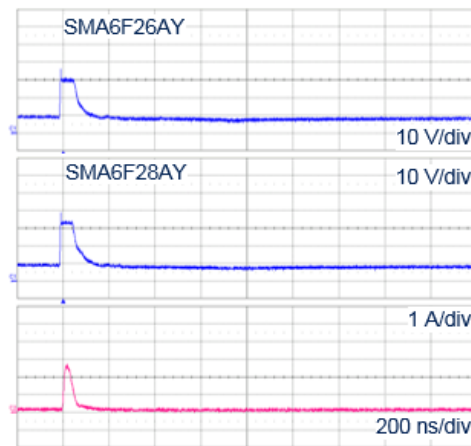
**Figure 13. ISO7637-2 pulse 2a:  $V_s = +112\text{ V}$  with 12 V battery**



**Figure 14. ISO7637-2 pulse 3a:  $V_s = -220\text{ V}$  with 12 V battery**



**Figure 15. ISO7637-2 pulse 3b:  $V_s = +150\text{ V}$  with 12 V battery**



## 2 Package information

In order to meet environmental requirements, ST offers these devices in different grades of **ECOPACK** packages, depending on their level of environmental compliance. ECOPACK specifications, grade definitions and product status are available at: [www.st.com](http://www.st.com). ECOPACK is an ST trademark.

### 2.1 SMA Flat package information

Figure 16. SMA Flat package outline

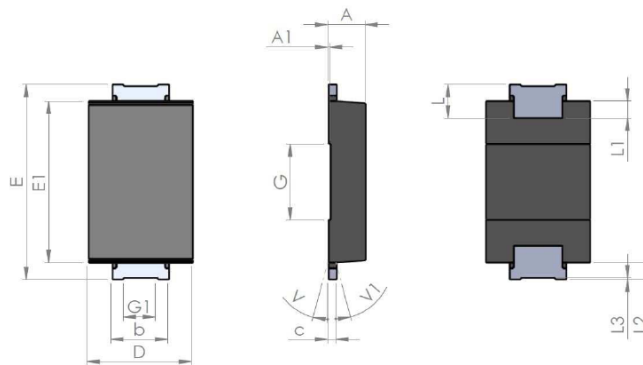
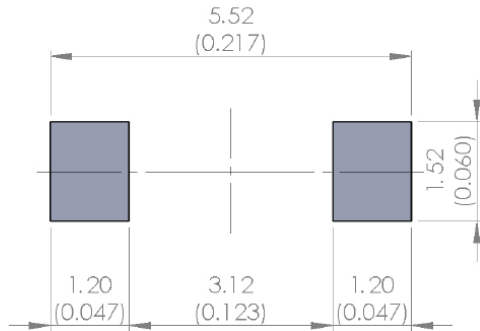


Table 3. SMA Flat mechanical data

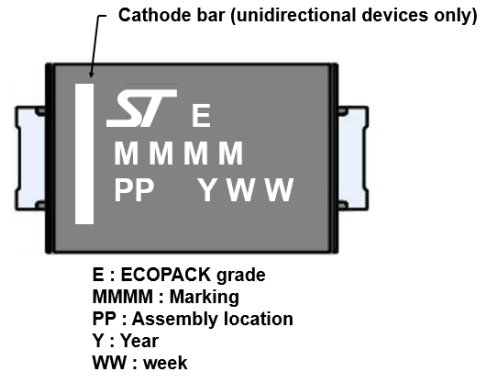
Symbol	Millimeters			Inches <sup>(1)</sup>		
	Min	Typ	Max	Min	Typ	Max
A	0.90		1.10	0.035		0.044
A1		0.05			0.002	
b	1.25		1.65	0.049		0.065
c	0.15		0.40	0.005		0.016
D	2.25		2.90	0.088		0.115
E	5.00		5.35	0.196		0.211
E1	3.95		4.60	0.155		0.182
G		2.00			0.079	
G1		0.85			0.033	
L	0.75		1.20	0.029		0.048
L1		0.45			0.018	
L2		0.45			0.018	
L3		0.05			0.002	
V			8°			8°
V1			8°			8°

1. Values in inches are converted from mm and rounded to 3 decimal digits.

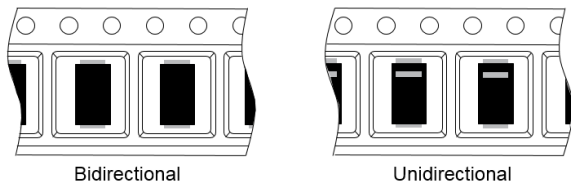
**Figure 17. SMA Flat recommended footprint in mm (inches)**



**Figure 18. SMA Flat marking**

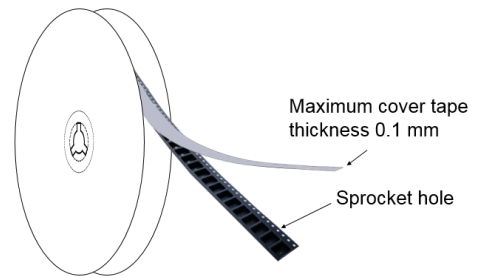


**Figure 19. Package orientation in reel**

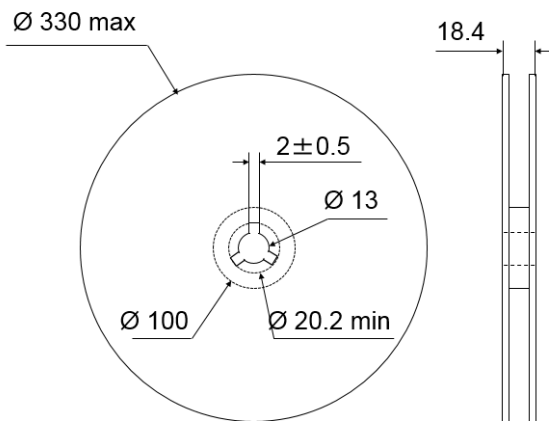


Taped according to EIA-481  
Pocket dimensions are not on scale.  
Pocket shape may vary depending on package  
On bidirectional devices, marking and logo may not be always in the same direction.

**Figure 20. Tape and reel orientation**



**Figure 21. 13" reel dimension values**



**Figure 22. Inner box dimension values**

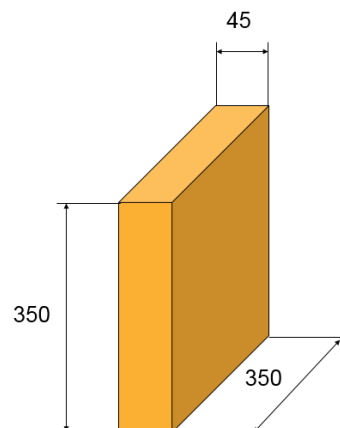
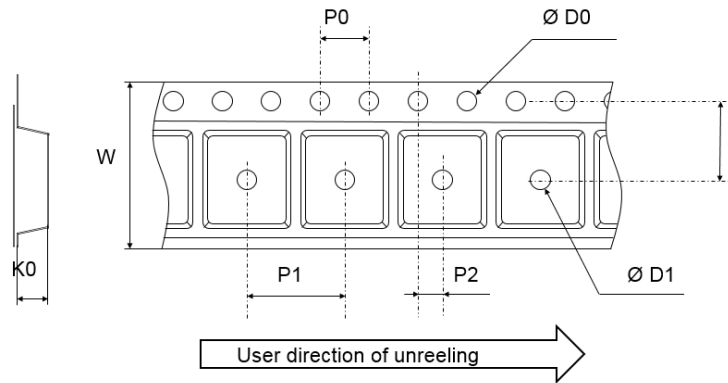




Figure 23. Tape outline



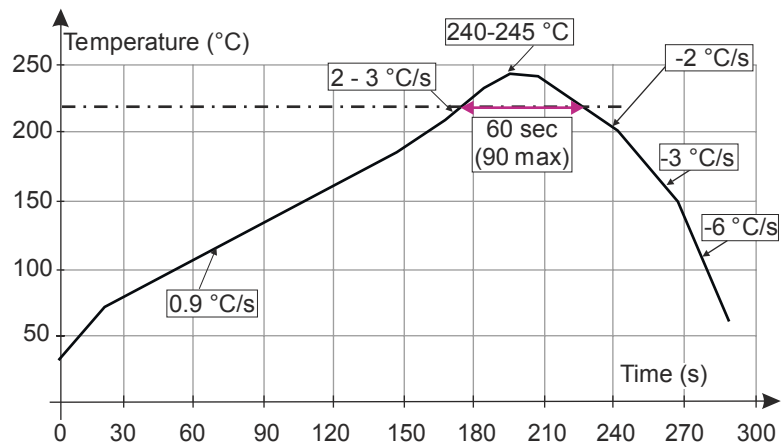
Note: Pocket dimensions are not on scale  
Pocket shape may vary depending on package

Table 4. Tape dimension values

Ref.	Dimensions		
	Millimeters		
	Min.	Typ.	Max.
D0	1.5	1.55	1.6
D1	1.5		
F	5.4	5.5	5.6
K0	1.1	1.2	1.3
P0	3.9	4.0	4.1
P1	3.9	4.0	4.1
P2	1.9	2.0	2.1
W	11.7	12	12.3

## 2.2 Reflow profile

Figure 24. ST ECOPACK recommended soldering reflow profile for PCB mounting



Note: Minimize air convection currents in the reflow oven to avoid component movement. Maximum soldering profile corresponds to the latest IPC/JEDEC J-STD-020.

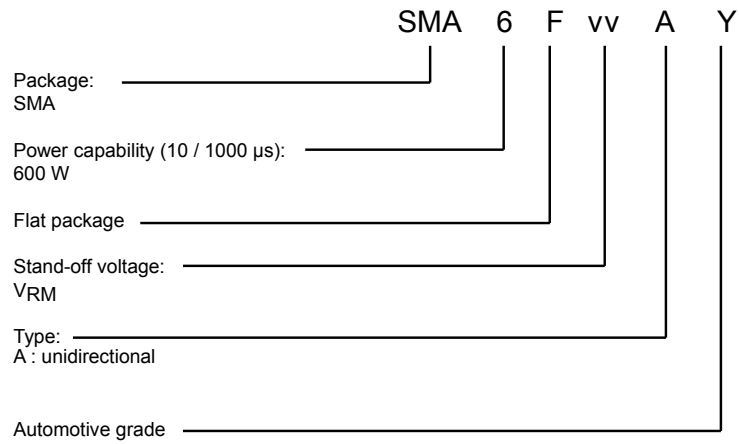
### **3 Application and design guidelines**

---

More information is available in the application note AN2689 “Protection of automotive electronics from electrical hazards, guidelines for design and component selection”.

## 4 Ordering information

**Figure 25. Ordering information scheme**



**Table 5. Ordering information**

Order code	Marking	Package	Weight	Base qty.	Delivery mode
SMA6FxxAY	See <a href="#">Table 6. Marking.</a>	SMA Flat	39 mg	10000	Tape and reel

## 4.1 Marking

**Table 6. Marking**

Order code	Marking
SMA6F5.0AY	6AIY
SMA6F6.0AY	6AKY
SMA6F6.5AY	6ALY
SMA6F8.5AY	6APY
SMA6F10AY	6ASY
SMA6F11AY	6AUY
SMA6F12AY	6AWY
SMA6F13AY	6AYY
SMA6F14AY	6BAY
SMA6F15AY	6BCY
SMA6F16AY	6BEY
SMA6F18AY	6BIY
SMA6F20AY	6BMY
SMA6F22AY	6BOY
SMA6F23AY	6BPY
SMA6F24AY	6BQY
SMA6F26AY	6BSY
SMA6F28AY	6BUY
SMA6F30AY	6BWY
SMA6F31AY	6BXY
SMA6F33AY	6BZY
SMA6F36AY	6CCY
SMA6F40AY	6CGY
SMA6F48AY	6COY
SMA6F58AY	6CYY
SMA6F64AY	6DEY
SMA6F70AY	6DKY
SMA6F85AY	6DZY
SMA6F100AY	6EOY
SMA6F130AY	6FSY
SMA6F154AY	6GQY
SMA6F170AY	6HGY
SMA6F188AY	6HYY

## Revision history

**Table 7. Document revision history**

Date	Version	Changes
24-Sep-2018	1	Initial release.
26-Aug-2019	2	Updated <a href="#">Table 1</a> . Absolute maximum ratings ( $T_{amb} = 25\text{ °C}$ ), <a href="#">Figure 10</a> . Thermal impedance junction to ambient versus pulse duration, <a href="#">Figure 11</a> . Thermal resistance junction to ambient versus copper area under each lead.
07-Jan-2020	3	Updated links syntax.

**IMPORTANT NOTICE – PLEASE READ CAREFULLY**

STMicroelectronics NV and its subsidiaries (“ST”) reserve the right to make changes, corrections, enhancements, modifications, and improvements to ST products and/or to this document at any time without notice. Purchasers should obtain the latest relevant information on ST products before placing orders. ST products are sold pursuant to ST’s terms and conditions of sale in place at the time of order acknowledgement.

Purchasers are solely responsible for the choice, selection, and use of ST products and ST assumes no liability for application assistance or the design of Purchasers’ products.

No license, express or implied, to any intellectual property right is granted by ST herein.

Resale of ST products with provisions different from the information set forth herein shall void any warranty granted by ST for such product.

ST and the ST logo are trademarks of ST. For additional information about ST trademarks, please refer to [www.st.com/trademarks](http://www.st.com/trademarks). All other product or service names are the property of their respective owners.

Information in this document supersedes and replaces information previously supplied in any prior versions of this document.

© 2020 STMicroelectronics – All rights reserved