

**REVISION HISTORY**  
 REV 1 - INITIAL RELEASE  
 REV 2 - REMOVE GROUND FROM PIN 1 & 9 OF J1  
 REV 2.1 - ADD JUMPER ACROSS JP1

**BOARD VARIATIONS:**

DB-LQFP48-LPC2101 U1 = LPC2101FBD48 \*  
 DB-LQFP48-LPC2102 U1 = LPC2102FBD48 \*  
 DB-LQFP48-LPC2103 U1 = LPC2103FBD48  
 DB-LQFP48-LPC2104 U1 = LPC2104BBD48 \*  
 DB-LQFP48-LPC2105 U1 = LPC2105BBD48 \*  
 DB-LQFP48-LPC2106 U1 = LPC2106BBD48  
 (\*) NOT NORMALLY STOCKED, AVAILABLE ON SPECIAL ORDER

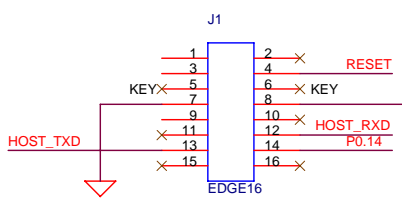
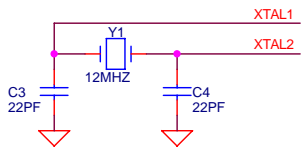
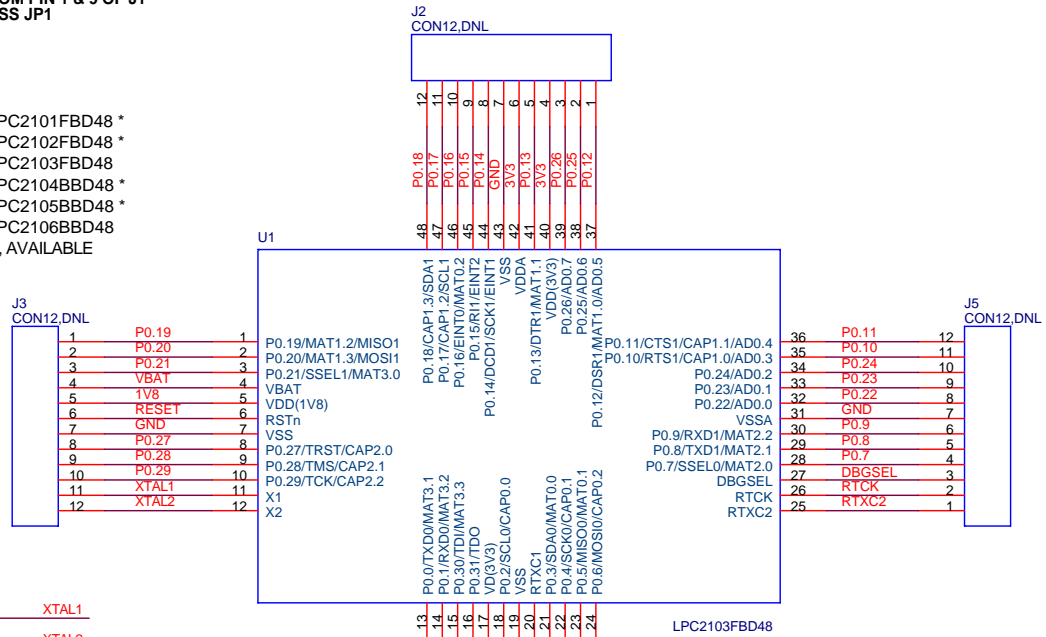

CONNECTOR TO USB-DONGLE

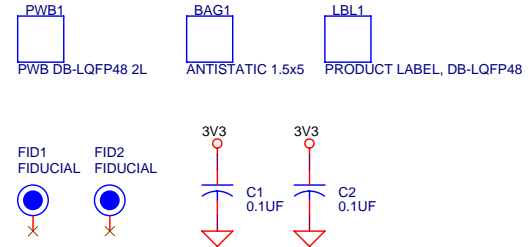
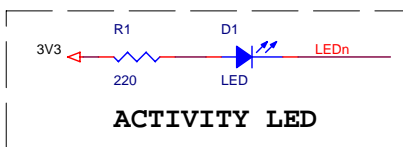
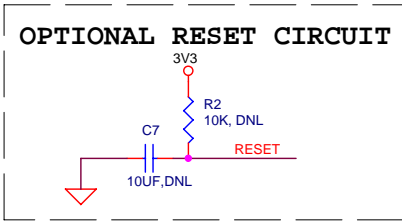
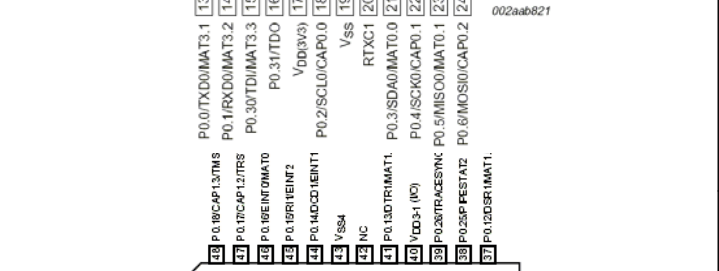
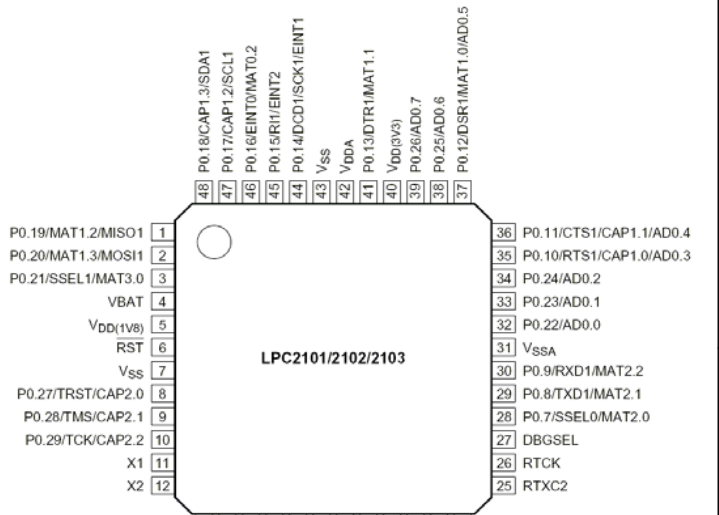
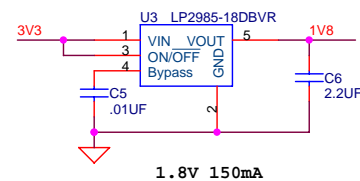
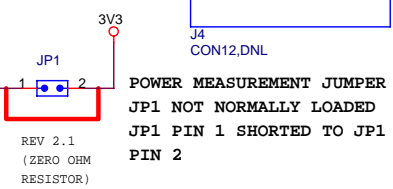

**Future Designs, Inc.**  
 Huntsville, AL

Title: DB-LQFP48

Size: Document Number

Date: Wednesday, June 20, 2007

Sheet: 1 of 1

Rev: 2.1