

10/100Base-T Vertical RJ w/ LEDs

ARJG11A-M0011AB

Request Samples



Check Inventory



16.0 X 16.7 X 16.9mm
RoHS/RoHS II Compliant
MSL Level = 1

Features

- Available with or without LED
- Suitable CAT 5 & 6 cable and UTP
- Comply IEEE 802.3ab
- LAN Magnetic with RJ4
- Suitable for RoHS compliant reflow

Applications

- 10/100 Base-T LAN
- NIC, LoM and PC
- Industrial IoT/IoT
- Machine-to-machine (M2M)
- Industrial process control
- Industrial robotics
- Media converters

Electrical Specifications

Parameters	Minimum	Typical	Maximum	Units	Notes
Turn Ratio ($\pm 3\%$)	1CT:1CT				100kHz, 0.1V
Inductance	350			μH	100kHz, 0.1V, 8mADC
Leakage Inductance			0.5	μH	100kHz, 0.1V
DC Resistance			1.5	Ω	
Hipot	2250			VDC	1mA Max Complies with IEEE 802.3
Operating Temperature	0		+70	$^{\circ}\text{C}$	
Storage Temperature	-25		+85	$^{\circ}\text{C}$	
Insertion Loss	-1.1			dB	0.5-100MHz
Return Loss			-18	dB	0.5-30MHz
			$-18+20\log(f/30)^*$		30.1-60MHz
			-12		60.1-80MHz
Crosstalk			-35	dB	0.5-40MHz
			$-33+20\log(f/50)^*$		40.1-100MHz
CMRR			-30	dB	0.5-100MHz



5101 Hidden Creek Ln Spicewood TX 78669
Phone: 512-371-6159 | Fax: 512-351-8858
For terms and conditions of sales, please visit:
www.abracon.com

REVISED: 1-21-20

ABRACON IS
ISO9001-2015
CERTIFIED

10/100Base-T Vertical RJ w/ LEDs

ARJG11A-M0011AB

Request Samples



Check Inventory



16.0 X 16.7 X 16.9mm
RoHS/RoHS II Compliant
 MSL Level = 1

Mechanical Specifications

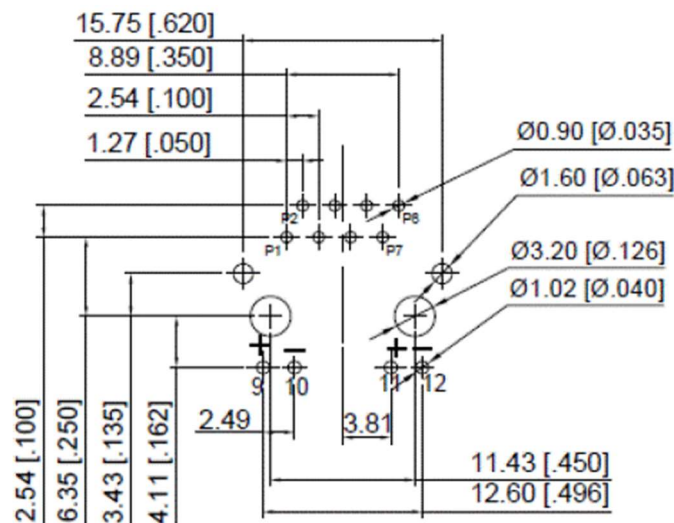
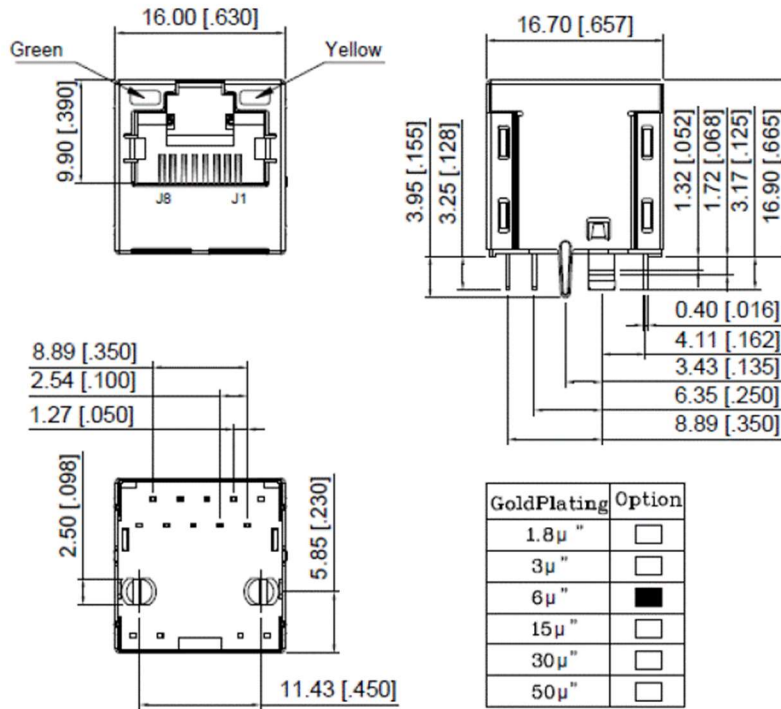

RECOMMENDED P.C.B LAYOUT
 TOP VIEW (COMPONENT SIDE)

Dimension Tolerance:
 PCB LAYOUT
 Tolerances: ±0.05 [.002]



5101 Hidden Creek Ln Spicewood TX 78669
 Phone: 512-371-6159 | Fax: 512-351-8858
 For terms and conditions of sales, please visit:
www.abracon.com

REVISED: 1-21-20

ABRACON IS
 ISO9001-2015
 CERTIFIED

10/100Base-T Vertical RJ w/ LEDs

ARJG11A-M0011AB

Request Samples



Check Inventory



16.0 X 16.7 X 16.9mm
RoHS/RoHS II Compliant
 MSL Level = 1

Schematic

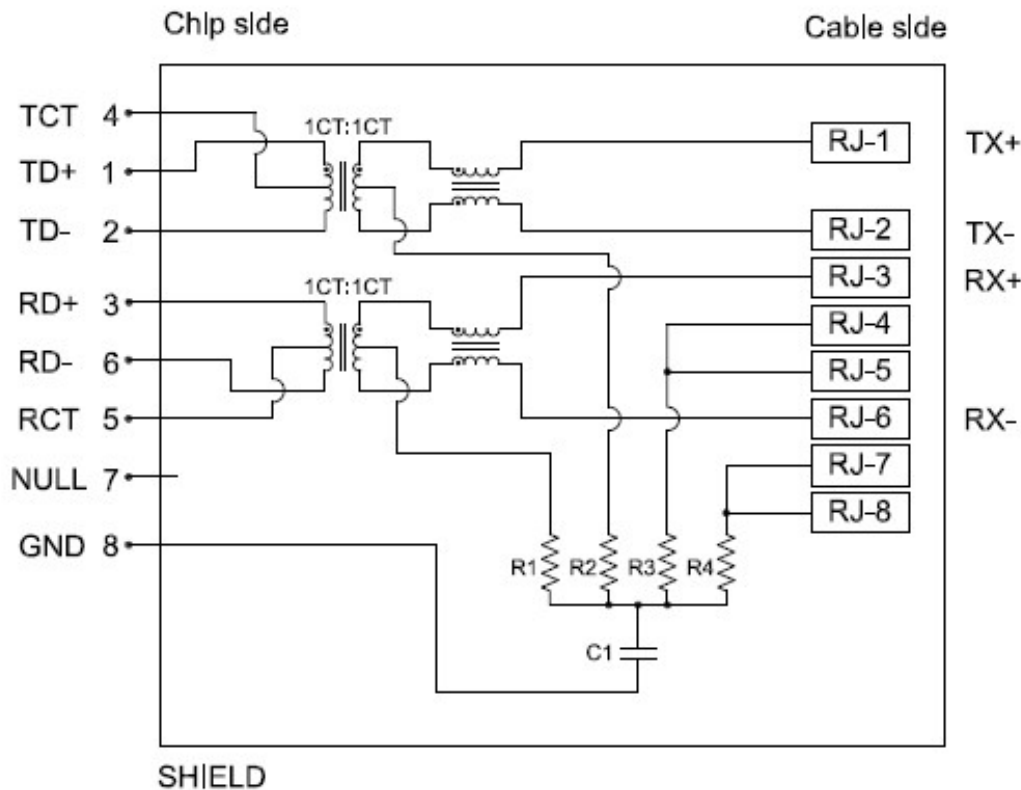

Note:
 R1-R4=75 OHMS, Resistors.
 C1=2KV 1000pF, Capacitor.

AB (Left: Green – Right: Yellow):

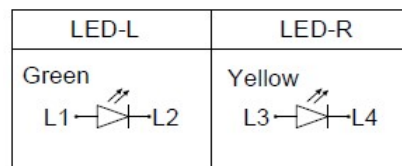

Color	Green	Yellow
Wavelength	565nm Typ	585nm Typ
Forward Voltage	2.2V Typ	2.1V Typ



5101 Hidden Creek Ln Spicewood TX 78669
 Phone: 512-371-6159 | Fax: 512-351-8858
 For terms and conditions of sales, please visit:
www.abracon.com

REVISED: 1-21-20

ABRACON IS
 ISO9001-2015
 CERTIFIED

10/100Base-T Vertical RJ w/ LEDs

ARJG11A-M0011AB

Request Samples



Check Inventory



16.0 X 16.7 X 16.9mm
RoHS/RoHS II Compliant
MSL Level = 1

Part Marking

Part number does not include packaging characters. Bulk/Trays is the only option.

XXXXXXXXXX

e.g.

M0011ABEWDB

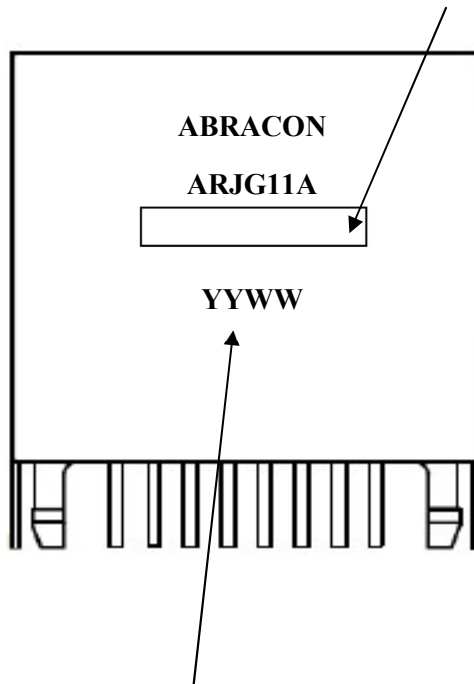

YY: Year: E.g. 19 for 2019

WW: Week: E.g. 05 for the 5th week of the year.

Marking Method = Laser Marking



5101 Hidden Creek Ln Spicewood TX 78669
Phone: 512-371-6159 | Fax: 512-351-8858
For terms and conditions of sales, please visit:
www.abracon.com

REVISED: 1-21-20

ABRACON IS
ISO9001-2015
CERTIFIED

10/100Base-T Vertical RJ w/ LEDs

ARJG11A-M0011AB

Request Samples



Check Inventory



16.0 X 16.7 X 16.9mm
RoHS/RoHS II Compliant
MSL Level = 1

Materials

1. Housing:

Material:

PBT, UL94V-0 (for wave soldering option)

LCP, UL94V-0 (for IR reflow soldering option)

Standard Color: Black

2. Insert:

Material:

PBT, UL94V-0 (for wave soldering option)

LCP, UL94V-0 (for IR Reflow soldering option)

Contact Material: Phosphor Bronze

Plating (1): Nickel

Plating (2): Gold, 6u"

3. Metal Shell:

Material: Brass

Plating (1): Nickel

4. Contact Pin:

Material: Phosphor Bronze

Plating (1): Nickel

Plating (2): 100%Sn

5. LED:

Material: Diffused Epoxy Lens, 0.5x0.5mm Carbon Steel wireframe leads

Note: Abracon LLC will not alter any material composition, without prior written notification.



5101 Hidden Creek Ln Spicewood TX 78669
Phone: 512-371-6159 | Fax: 512-351-8858
For terms and conditions of sales, please visit:
www.abracon.com

REVISED: 1-21-20

ABRACON IS
ISO9001-2015
CERTIFIED

10/100Base-T Vertical RJ w/ LEDs

ARJG11A-M0011AB

Request Samples



Check Inventory



16.0 X 16.7 X 16.9mm
RoHS/RoHS II Compliant
 MSL Level = 1

Part Identification

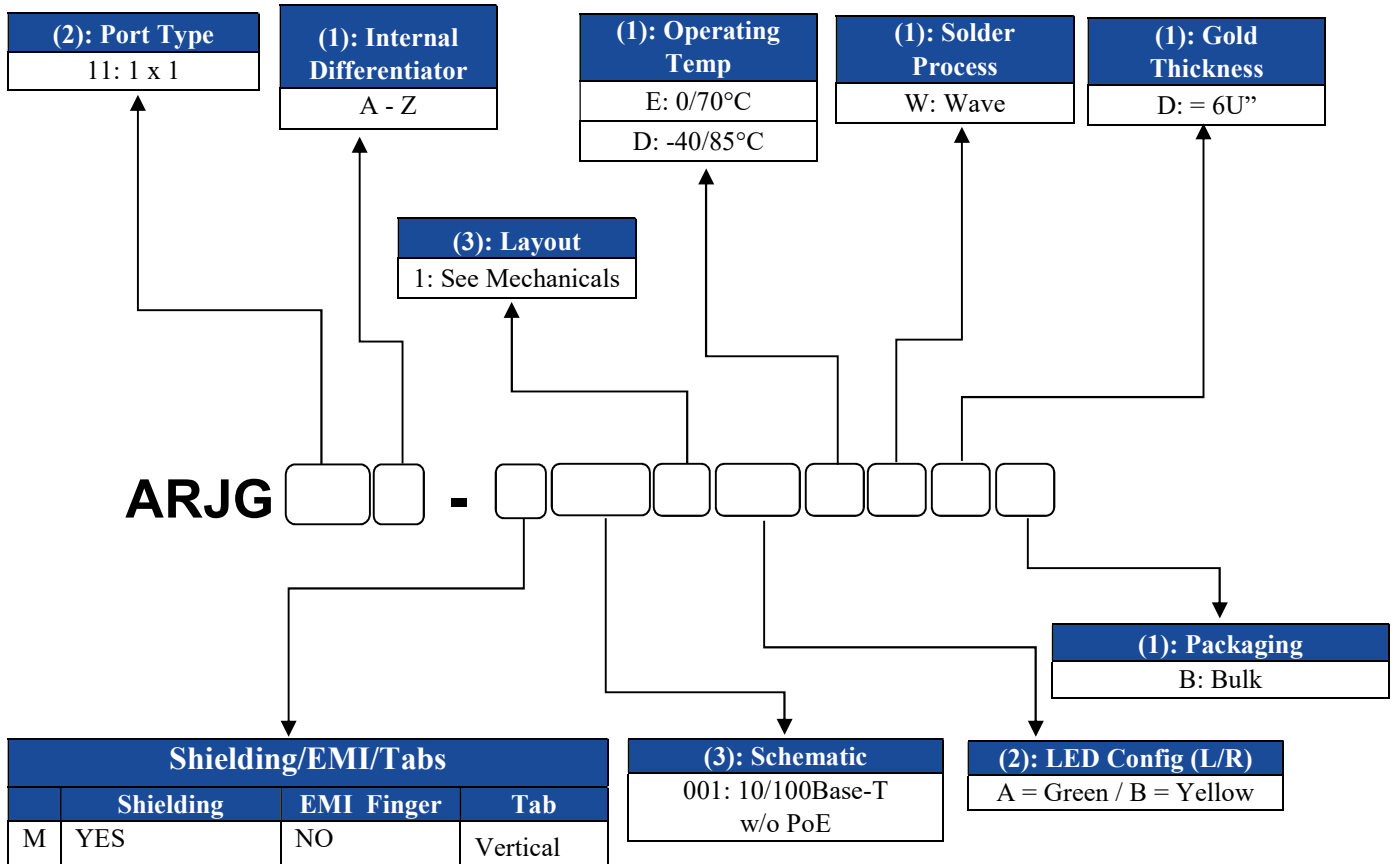

5101 Hidden Creek Ln Spicewood TX 78669
 Phone: 512-371-6159 | Fax: 512-351-8858
 For terms and conditions of sales, please visit:
www.abracon.com

REVISED: 1-21-20

ABRACON IS
 ISO9001-2015
 CERTIFIED

10/100Base-T Vertical RJ w/ LEDs

ARJG11A-M0011AB

Request Samples



Check Inventory



16.0 X 16.7 X 16.9mm
 RoHS/RoHS II Compliant
 MSL Level = 1

Reflow Profile

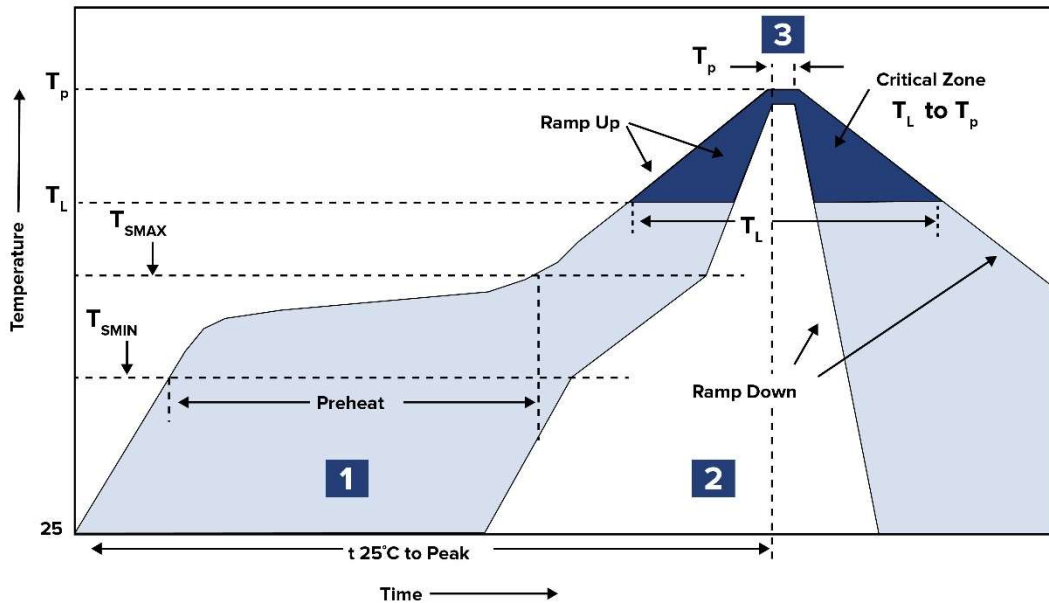

	Description	Temperature	Times
1	Preheat	$T_{SMIN} \sim T_{SMAX}$ 150°C ~ 180°C	120 ~ 180 sec.
2	Reflow	T_L 217°C	60 ~ 150 sec.
3	Peak heat	T_P 245°C±5°C	5 sec. MAX

10/100Base-T Vertical RJ w/ LEDs

ARJG11A-M0011AB

Request Samples



Check Inventory



16.0 X 16.7 X 16.9mm
RoHS/RoHS II Compliant
MSL Level = 1

Packaging

Bulk/Tray (60pcs/tray, 22 trays/carton)

Tray Size: L315.0 x W200.0 mm, Transparent PET

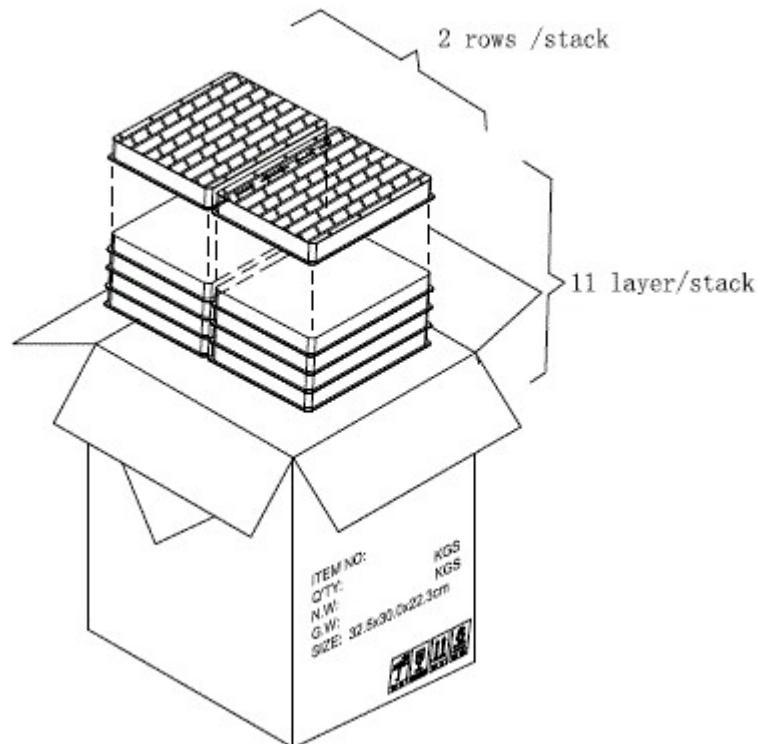
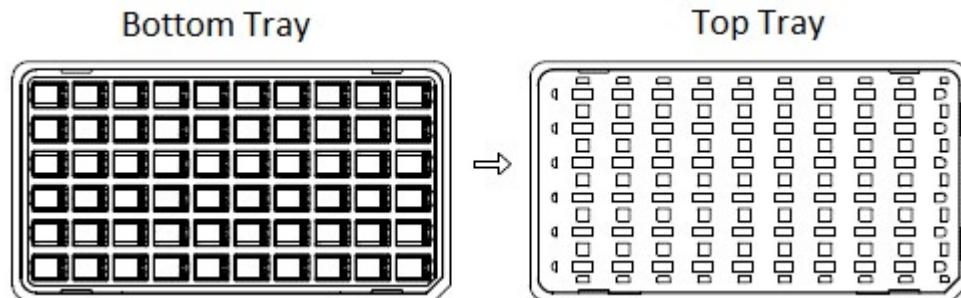

Dimensions: mm



5101 Hidden Creek Ln Spicewood TX 78669
Phone: 512-371-6159 | Fax: 512-351-8858
For terms and conditions of sales, please visit:
www.abracon.com

REVISED: 1-21-20

ABRACON IS
ISO9001-2015
CERTIFIED

10/100Base-T Vertical RJ w/ LEDs

ARJG11A-M0011AB

Request Samples



Check Inventory



16.0 X 16.7 X 16.9mm
RoHS/RoHS II Compliant
MSL Level = 1

Notes

- i) The parts are manufactured in accordance with this specification. If other conditions and specifications which are required for this specification, please contact ABRACON for more information.
- ii) ABRACON will supply the parts in accordance with this specification unless we receive a written request to modify prior to an order placement.
- iii) In no case shall ABRACON be liable for any product failure from in appropriate handling or operation of the item beyond the scope of this specification.
- iv) When changing your production process, please notify ABRACON immediately.
- v) ABRACON's products are COTS – Commercial-Off-The-Shelf products; suitable for Commercial, Industrial and, where designated, Automotive Applications. ABRACON's products are not specifically designed for Military, Aviation, Aerospace, Life-dependant Medical applications or any application requiring high reliability where component failure could result in loss of life and/or property. For applications requiring high reliability and/or presenting an extreme operating environment, written consent and authorization from ABRACON is required. Please contact ABRACON for more information.



5101 Hidden Creek Ln Spicewood TX 78669
Phone: 512-371-6159 | Fax: 512-351-8858
For terms and conditions of sales, please visit:
www.abracon.com

REVISED: 1-21-20

ABRACON IS
ISO9001-2015
CERTIFIED