

MTP IGBT Power Module Primary Rectifier and PFC



MTP

**RoHS
COMPLIANT**

FEATURES

- Input rectifier bridge
- PFC stage with warp 2 IGBT and FRED Pt® hyperfast diode
- Very low stray inductance design for high speed operation
- Integrated thermistor
- Isolated baseplate
- UL approved file E78996
- Designed and qualified for industrial level
- Material categorization: for definitions of compliance please see www.vishay.com/doc?99912

BENEFITS

- Lower conduction losses and switching losses
- Optimized for welding, UPS, and SMPS applications
- PCB solderable terminals
- Direct mounting to heatsink

PRODUCT SUMMARY

INPUT BRIDGE DIODE, T _J = 150 °C	
V _{RRM}	1200 V
I _O at 80 °C	48 A
V _{FM} at 25 °C at 20 A	1.05 V
PFC IGBT, T _J = 150 °C	
V _{CES}	600 V
V _{CE(on)} at 25 °C at 40 A	1.93 V
I _C at 80°C	66 A
FRED Pt® PFC DIODE, T _J = 150 °C	
V _R	600 V
I _{F(DC)} at 80 °C	55 A
V _F at 25 °C at 40 A	1.76 V
FRED Pt® AP DIODE, T _J = 150 °C	
V _R	600 V
I _{F(DC)} at 80 °C	13 A
V _F at 25 °C at 4 A	1.1 V
Speed	30 kHz to 150 kHz
Package	MTP
Circuit	Input rectifier bridge

ABSOLUTE MAXIMUM RATINGS

	PARAMETER	SYMBOL	TEST CONDITIONS	MAX.	UNITS
Input Rectifier Bridge	Repetitive peak reverse voltage	V _{RRM}		1200	V
	Maximum average output current T _J = 150 °C maximum	I _O	T _C = 80 °C	48	A
	Surge current (Non-repetitive)	I _{FSM}	Rated V _{RRM} applied	250	
	Maximum I ² t for fusing	I ² t	10 ms, sine pulse	316	A ² s
PFC IGBT	Collector to emitter voltage	V _{CES}	T _J = 25 °C	600	V
	Gate to emitter voltage	V _{GE}	I _{GES} max. ± 250 ns	± 20	
	Maximum continuous collector current at V _{GE} = 15 V, T _J = 150 °C maximum	I _C	T _C = 25 °C	96	A
			T _C = 80 °C	66	
	Pulsed collector current	I _{CM} ⁽¹⁾		250	
	Clamped inductive load current	I _{LM}		250	
Maximum power dissipation	P _D	T _C = 25 °C	378	W	



ABSOLUTE MAXIMUM RATINGS					
	PARAMETER	SYMBOL	TEST CONDITIONS	MAX.	UNITS
PFC Diode	Repetitive peak reverse voltage	V_{RRM}		600	V
	Maximum continuous forward current $T_J = 150\text{ °C}$ maximum	I_F	$T_C = 25\text{ °C}$	82	A
			$T_C = 80\text{ °C}$	55	
	Maximum power dissipation	P_D	$T_C = 25\text{ °C}$	181	W
Maximum non-repetitive peak current	I_{FSM}	$T_C = 25\text{ °C}$	360	A	
AP Diode	Repetitive peak reverse voltage	V_{RRM}		600	V
	Maximum continuous forward current $T_J = 150\text{ °C}$ maximum	I_F	$T_C = 25\text{ °C}$	21	A
			$T_C = 80\text{ °C}$	13	
	Maximum power dissipation	P_D	$T_C = 25\text{ °C}$	32	W
Maximum non-repetitive peak current	I_{FSM}	$T_C = 25\text{ °C}$	60	A	
	Maximum operating junction temperature	T_J		150	°C
	Storage temperature range	T_{Stg}		-40 to +150	
	RMS isolation voltage	V_{ISOL}	$V_{RMS} t = 1\text{ s}, T_J = 25\text{ °C}$	3500	W

ΔR CONDUCTION PER JUNCTION - SINGLE PHASE BRIDGE DIODE											
DEVICES	SINE HALF WAVE CONDUCTION					RECTANGULAR WAVE CONDUCTION					UNITS
	180°	120°	90°	60°	30°	180°	120°	90°	60°	30°	
70MT060WSP	0.273	0.302	0.322	0.338	0.350	0.236	0.288	0.294	0.287	0.235	°C/W

ELECTRICAL SPECIFICATIONS ($T_J = 25\text{ °C}$ unless otherwise noted)							
	PARAMETER	SYMBOL	TEST CONDITIONS	MIN.	TYP.	MAX.	UNITS
Input Rectifier Bridge	Blocking voltage	BV_{RRM}	$I_R = 250\text{ }\mu\text{A}$	1200	-	-	V
	Reverse leakage current	I_{RRM}	$V_{RRM} = 1200\text{ V}$	-	-	0.1	mA
			$V_{RRM} = 1200\text{ V}, T_J = 150\text{ °C}$	-	-	3.0	
	Forward voltage drop	V_{FM}	$I_F = 20\text{ A}$	-	1.05	1.2	V
			$I_F = 20\text{ A}, T_J = 150\text{ °C}$	-	0.94	1.0	
Forward slope resistance	r_t	$T_J = 150\text{ °C}$	-	-	8.7	mΩ	
Conduction threshold voltage	V_T		-	-	0.94	V	
PFC IGBT	Collector to emitter breakdown voltage	BV_{CES}	$V_{GE} = 0\text{ V}, I_C = 0.5\text{ mA}$	600	-	-	V
	Temperature coefficient of breakdown voltage	$\Delta V_{BR(CES)}/\Delta T_J$	$I_C = 0.5\text{ mA} (25\text{ °C to }125\text{ °C})$	-	0.6	-	V/°C
	Collector to emitter voltage	$V_{CE(ON)}$	$V_{GE} = 15\text{ V}, I_C = 40\text{ A}$	-	1.93	2.15	V
			$V_{GE} = 15\text{ V}, I_C = 40\text{ A}, T_J = 125\text{ °C}$	-	2.30	2.55	
	Gate threshold voltage	$V_{GE(th)}$	$V_{CE} = V_{GE}, I_C = 500\text{ }\mu\text{A}$	2.9	-	5.6	V
	Collector to emitter leakage current	I_{CES}	$V_{GE} = 0\text{ V}, V_{CE} = 600\text{ V}$	-	-	0.1	mA
$V_{GE} = 0\text{ V}, V_{CE} = 600\text{ V}, T_J = 125\text{ °C}$			-	-	1		
Gate to emitter leakage	I_{GES}	$V_{GE} = \pm 20\text{ V}$	-	-	± 100	nA	
PFC Diode	Forward voltage drop	V_{FM}	$I_F = 40\text{ A}$	-	1.76	2.23	V
			$I_F = 40\text{ A}, T_J = 125\text{ °C}$	-	1.34	1.62	
	Blocking voltage	BV_{RM}	$I_R = 0.5\text{ mA}$	600	-	-	
	Reverse leakage current	I_{RM}	$V_{RRM} = 600\text{ V}$	-	-	75	μA
$V_{RRM} = 600\text{ V}, T_J = 125\text{ °C}$			-	-	0.5		
AP Diode	Forward voltage drop	V_{FM}	$I_F = 4\text{ A}$	-	1.1	1.28	V
			$I_F = 4\text{ A}, T_J = 125\text{ °C}$	-	0.95	1.09	



ELECTRICAL SPECIFICATIONS ($T_J = 25\text{ }^\circ\text{C}$ unless otherwise noted)							
	PARAMETER	SYMBOL	TEST CONDITIONS	MIN.	TYP.	MAX.	UNITS
RECOVERY PARAMETER							
PFC Diode	Peak reverse recovery current	I_{rr}	$I_F = 40\text{ A}$ $di/dt = 200\text{ A}/\mu\text{s}$ $V_R = 200\text{ V}$	-	4	7	A
	Reverse recovery time	t_{rr}		-	59	79	ns
	Reverse recovery charge	Q_{rr}		-	118	180	nC
	Peak reverse recovery current	I_{rr}	$I_F = 40\text{ A}, T_J = 125\text{ }^\circ\text{C}$ $di/dt = 200\text{ A}/\mu\text{s}$ $V_R = 200\text{ V}$	-	12	17	A
	Reverse recovery time	t_{rr}		-	127	170	ns
	Reverse recovery charge	Q_{rr}		-	733	1200	nC
AP Diode	Peak reverse recovery current	I_{rr}	$I_F = 4\text{ A}$ $di/dt = 200\text{ A}/\mu\text{s}$ $V_R = 200\text{ V}$	-	7	10	A
	Reverse recovery time	t_{rr}		-	78	120	ns
	Reverse recovery charge	Q_{rr}		-	290	600	nC

SWITCHING CHARACTERISTICS ($T_J = 25\text{ }^\circ\text{C}$ unless otherwise noted)								
	PARAMETER	SYMBOL	TEST CONDITIONS	MIN.	TYP.	MAX.	UNITS	
PFC IGBT	Total gate charge	Q_g	$I_C = 50\text{ A}$ $V_{CC} = 400\text{ V}$ $V_{GE} = 15\text{ V}$	-	320	-	nC	
	Gate to source charge	Q_{gs}		-	42	-		
	Gate to drain (Miller) charge	Q_{gd}		-	110	-		
	Turn-on switching loss	E_{on}	$I_C = 70\text{ A}, V_{CC} = 360\text{ V}, V_{GE} = 15\text{ V}$ $R_g = 5\text{ }\Omega, L = 500\text{ }\mu\text{H}, T_J = 25\text{ }^\circ\text{C}$	-	0.13	-	mJ	
	Turn-off switching loss	E_{off}		-	0.18	-		
	Total switching loss	E_{tot}		-	0.31	-		
	Turn-on delay time	$t_{d(on)}$		-	193	-	ns	
	Rise time	t_r		-	35	-		
	Turn-off delay time	$t_{d(off)}$		-	202	-		
	Fall time	t_f		-	49	-		
	Turn-on switching loss	E_{on}		$I_C = 70\text{ A}, V_{CC} = 360\text{ V}, V_{GE} = 15\text{ V}$ $R_g = 5\text{ }\Omega, L = 500\text{ }\mu\text{H}, T_J = 125\text{ }^\circ\text{C}$	-	0.25	-	mJ
	Turn-off switching loss	E_{off}			-	0.32	-	
	Total switching loss	E_{tot}			-	0.57	-	
	Turn-on delay time	$t_{d(on)}$	-		193	-	ns	
	Rise time	t_r	-		35	-		
	Turn-off delay time	$t_{d(off)}$	-		208	-		
	Fall time	t_f	-		66	-		
	Input capacitance	C_{ies}	$V_{GE} = 0\text{ V}$ $V_{CC} = 30\text{ V}$ $f = 1\text{ MHz}$		-	7430	-	pF
	Output capacitance	C_{oes}		-	530	-		
	Reverse transfer capacitance	C_{res}		-	94	-		
Reverse bias safe operating area	RBSOA	$I_C = 250\text{ A}, V_{CC} = 400\text{ V}, V_P = 600\text{ V},$ $R_g = 22\text{ }\Omega, V_{GE} = 15\text{ V}, L = 500\text{ }\mu\text{H},$ $T_J = 150\text{ }^\circ\text{C}$	Full square					

THERMISTOR ELECTRICAL CHARACTERISTICS ($T_J = 25\text{ }^\circ\text{C}$ unless otherwise noted)							
PARAMETER	SYMBOL	TEST CONDITIONS	MIN.	TYP.	MAX.	UNITS	
Resistance	R	$T_J = 25\text{ }^\circ\text{C}$	-	30 000	-	Ω	
B value	B	$T_J = 25\text{ }^\circ\text{C}/T_J = 85\text{ }^\circ\text{C}$	-	4000	-	K	

Notes

- Repetitive rating; pulsed with limited by maximum junction temperature.

THERMAL AND MECHANICAL SPECIFICATIONS						
	PARAMETER	SYMBOL	MIN.	TYP.	MAX.	UNITS
Input Rectifier Bridge	Junction to case diode thermal resistance	R_{thJC}	-	-	0.9	°C/W
PFC IGBT	Junction to case IGBT thermal resistance		-	-	0.33	
PFC Diode	Junction to case PFC diode thermal resistance		-	-	0.69	
AP Diode	Junction to case AP diode thermal resistance		-	-	3.92	
	Case to sink, flat, greased surface per module	R_{thCS}	-	0.06	-	°C/W
	Mounting torque $\pm 10\%$ to heatsink ⁽¹⁾		-	-	4	Nm
	Approximate weight		-	65	-	g

Notes

- A mounting compound is recommended and the torque should be rechecked after a period of 3 hours to allow for the spread of the compound. Lubricated threads.

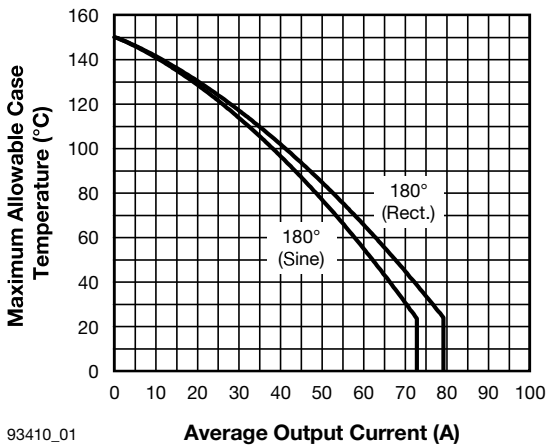

93410_01

Fig. 1 - Single Phase Input Bridge Output Current Ratings Characteristics

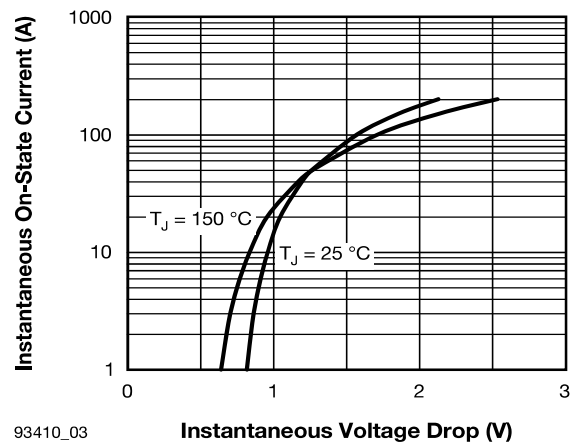

93410_03

Fig. 3 - Single Phase Input Bridge On-State Voltage Drop Characteristics

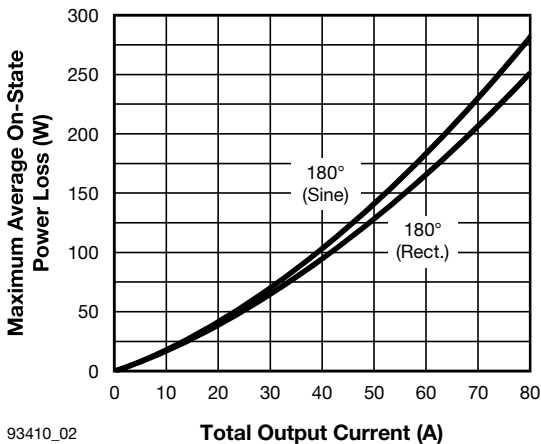

93410_02

Fig. 2 - Single Phase Bridge On-State Power Loss Characteristics

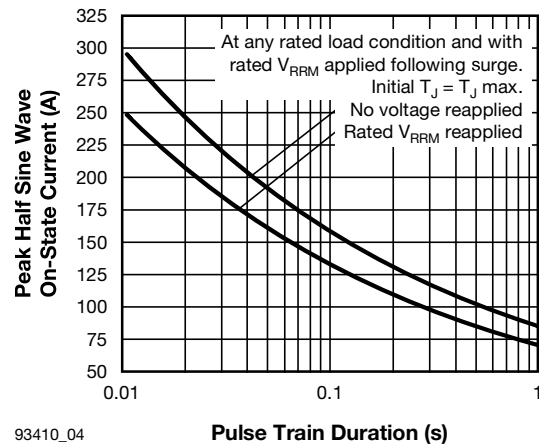

93410_04

Fig. 4 - Single Phase Input Bridge Maximum Non-Repetitive Surge Current (Per Junction)

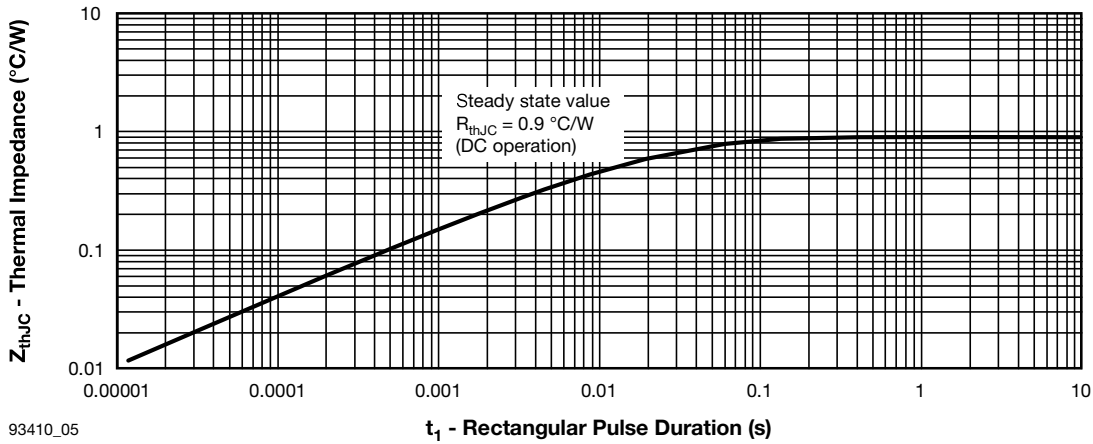

93410_05
Fig. 5 - Maximum Input Bridge Thermal Impedance Z_{thJC} Characteristics (Per Junction)

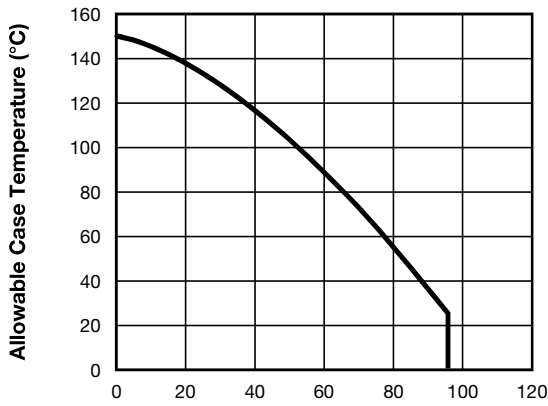

93410_06
Fig. 6 - Maximum IGBT Continuous Collector Current vs. Case Temperature

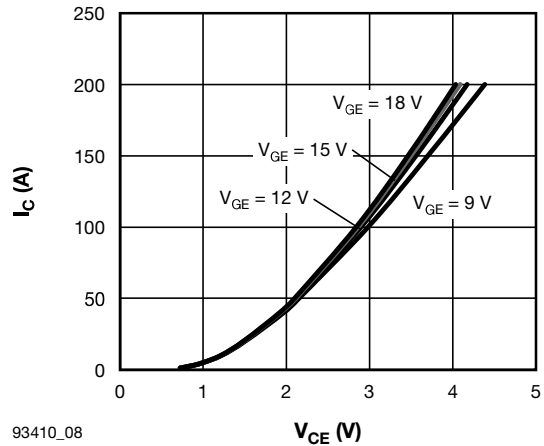

93410_08
Fig. 8 - Typical IGBT Output Characteristics, $T_J = 25\text{ }^\circ\text{C}$

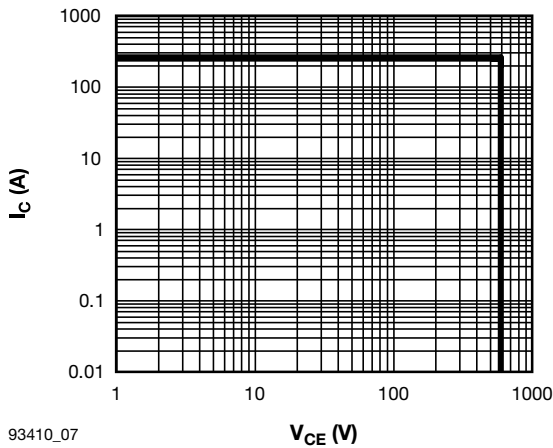

93410_07
Fig. 7 - IGBT Reverse BIAS SOA $T_J = 150\text{ }^\circ\text{C}$, $V_{GE} = 15\text{ V}$

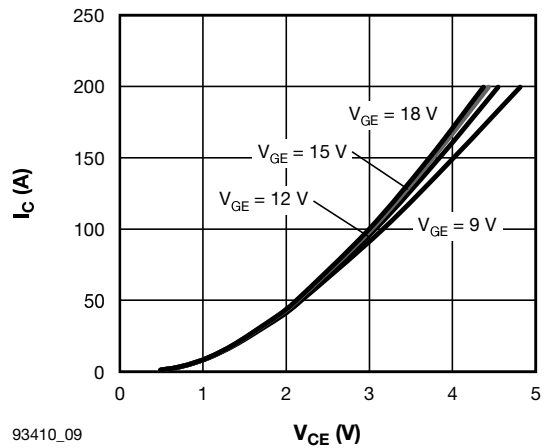

93410_09
Fig. 9 - Typical IGBT Output Characteristics, $T_J = 125\text{ }^\circ\text{C}$

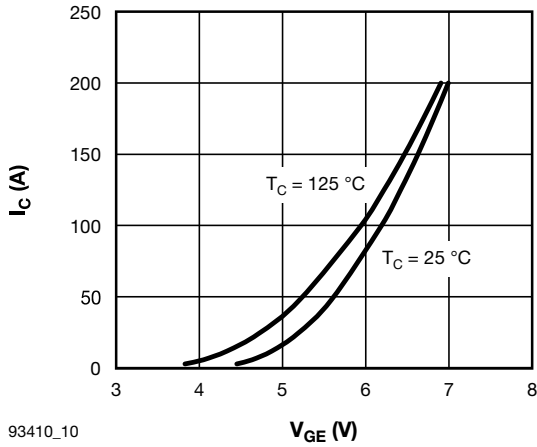

93410_10

Fig. 10 - Typical IGBT Transfer Characteristics, $T_J = 125\text{ }^\circ\text{C}$

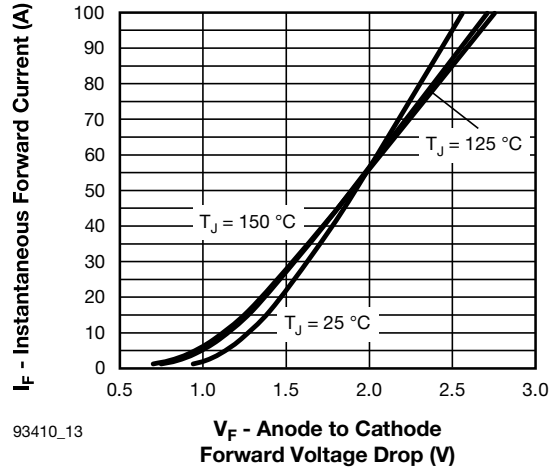

93410_13

Fig. 13 - Typical Diode Forward Voltage Characteristics of Antiparallel Diode, $t_p = 500\text{ }\mu\text{s}$

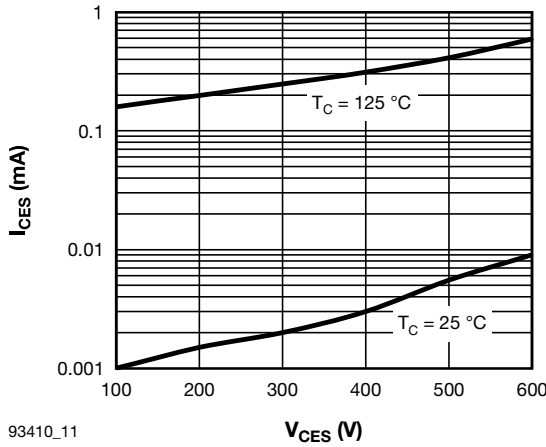

93410_11

Fig. 11 - Typical IGBT Zero Gate Voltage Collector Current

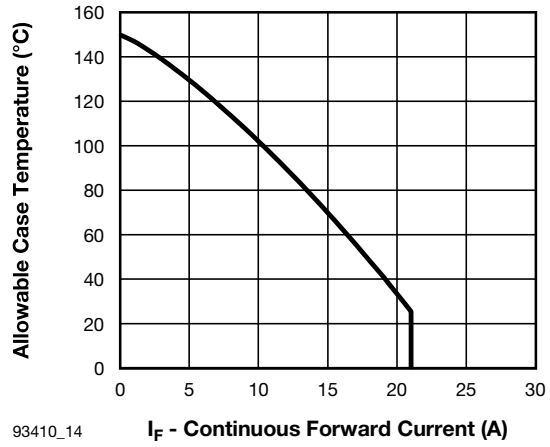

93410_14

Fig. 14 - Maximum Continuous Forward Current vs. Case Temperature Antiparallel Diode

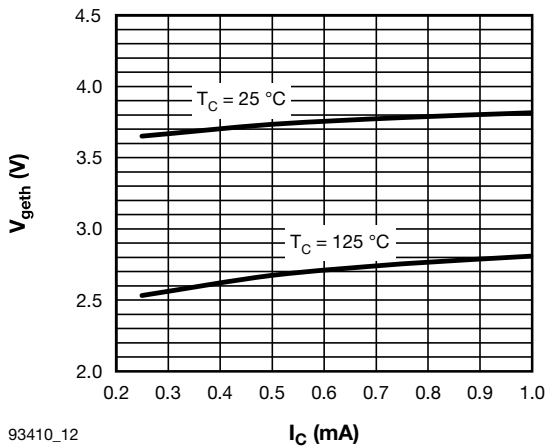

93410_12

Fig. 12 - Typical IGBT Gate Threshold Voltage

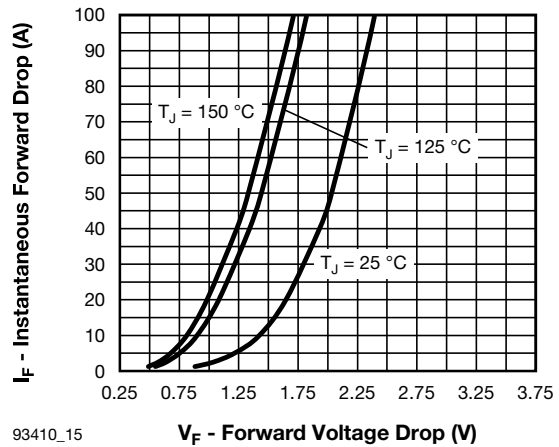

93410_15

Fig. 15 - Typical PFC Diode Forward Voltage

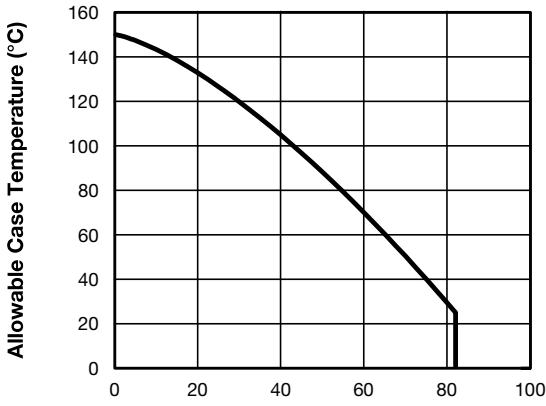

93410_16 **I_F - Continuous Forward Current (A)**
Fig. 16 - Maximum Continuous Forward Current vs. Case Temperature PFC Diode

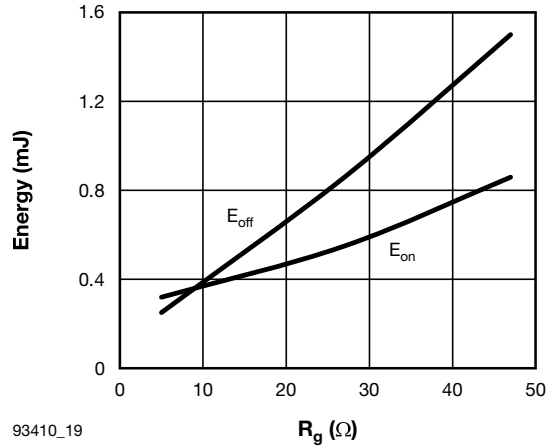

93410_19 **R_g (Ω)**
Fig. 19 - Typical IGBT Energy Loss vs. R_g
T_J = 125 °C, I_C = 70 A, V_{CC} = 360 V, V_{GE} = 15 V, L = 500 μH, R_g = 5 Ω

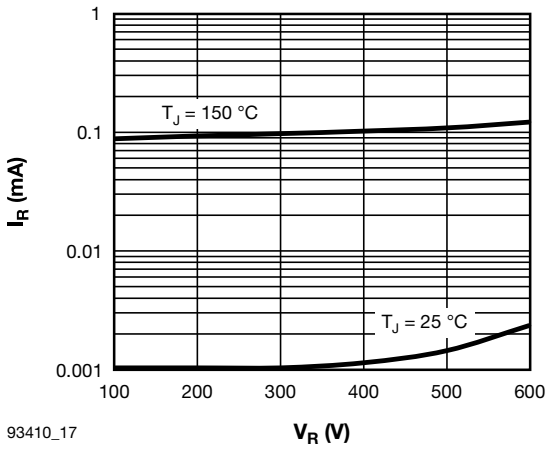

93410_17 **V_R (V)**
Fig. 17 - Typical FRED Pt® Chopper Diode Reverse Current vs. Reverse Voltage

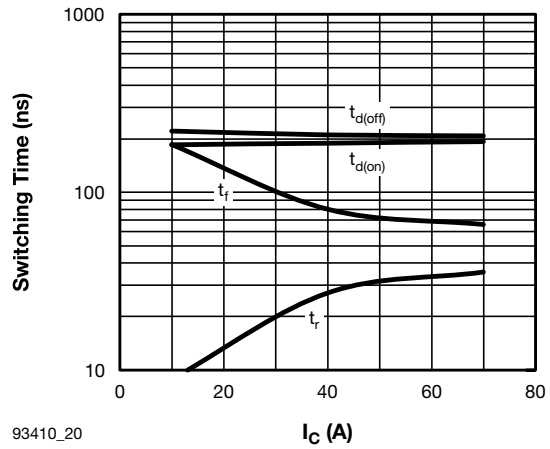

93410_20 **I_C (A)**
Fig. 20 - Typical IGBT Switching Time vs. I_C
T_J = 125 °C, V_{CC} = 360 V, V_{GE} = 15 V, L = 500 μH, R_g = 5 Ω

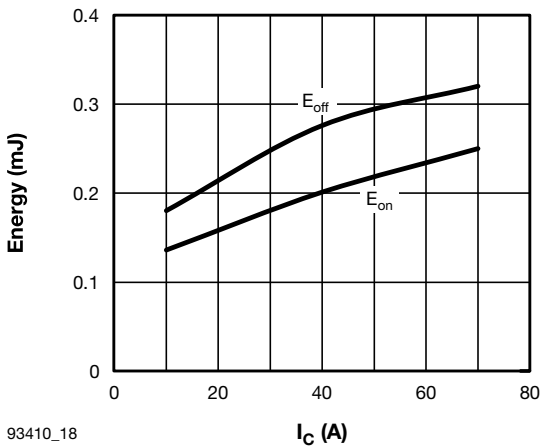

93410_18 **I_C (A)**
Fig. 18 - Typical IGBT Energy Loss vs. I_C
T_J = 125 °C, V_{CC} = 360 V, V_{GE} = 15 V, L = 500 μH, R_g = 5 Ω

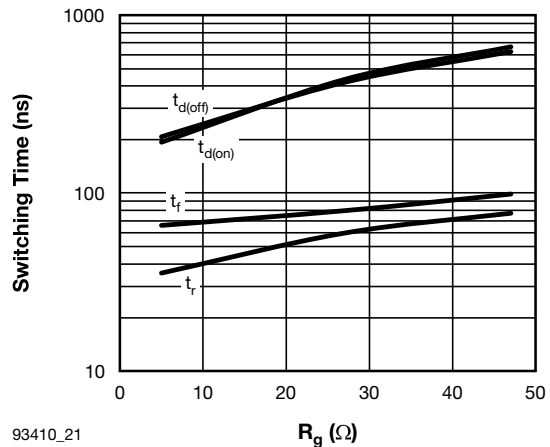

93410_21 **R_g (Ω)**
Fig. 21 - Typical IGBT Switching Time vs. R_g
T_J = 125 °C, I_C = 70 A, V_{CE} = 360 V, V_{GE} = 15 V, L = 500 μH

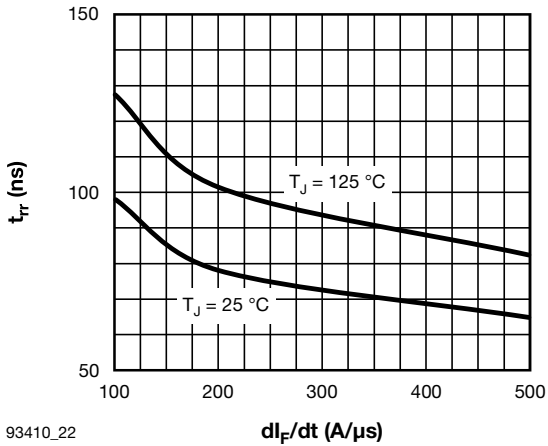

93410_22

Fig. 22 - Typical t_{rr} Antiparallel Diode vs. dI_F/dt
 $V_{rr} = 200$ V, $I_F = 4$ A

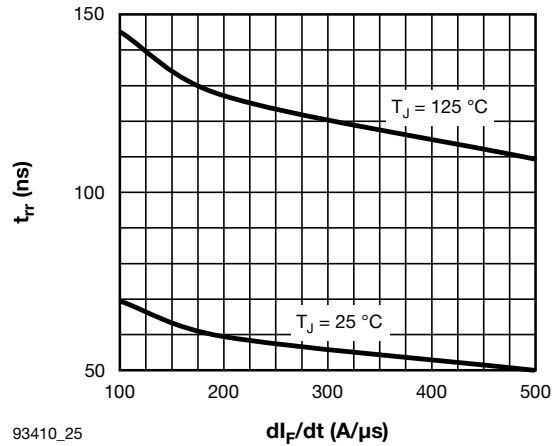

93410_25

Fig. 25 - Typical t_{rr} Chopper Diode vs. dI_F/dt , $V_{rr} = 200$ V, $I_F = 40$ A

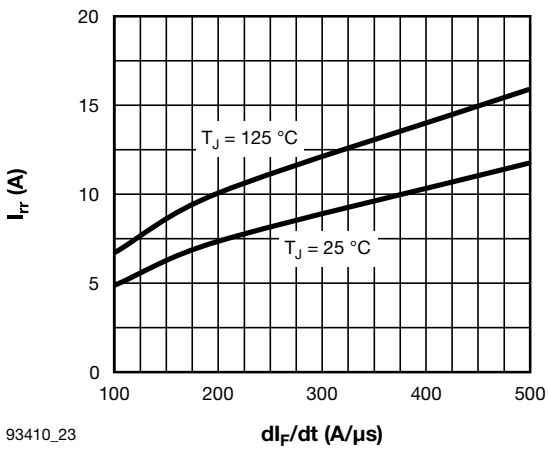

93410_23

Fig. 23 - Typical I_{rr} Antiparallel Diode vs. dI_F/dt
 $V_{rr} = 200$ V, $I_F = 4$ A

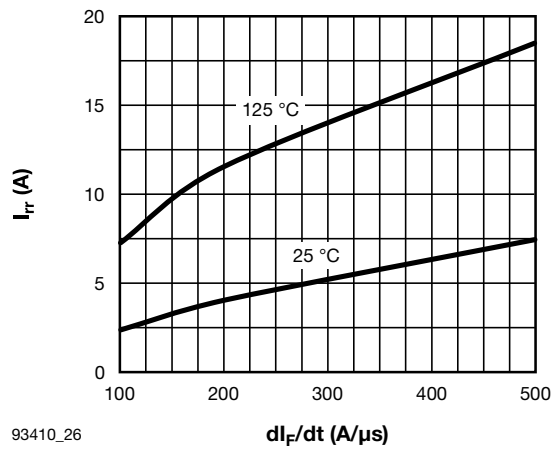

93410_26

Fig. 26 - Typical I_{rr} Chopper Diode vs. dI_F/dt
 $V_{rr} = 200$ V, $I_F = 40$ A

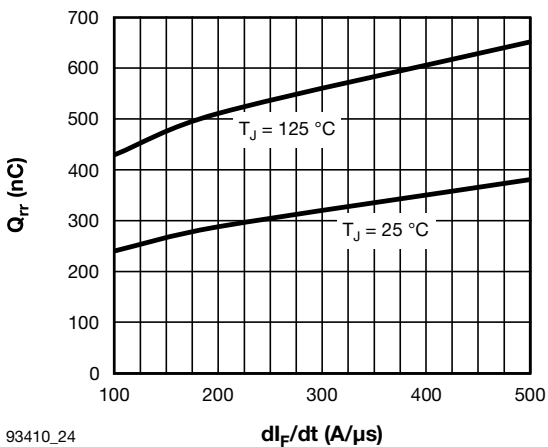

93410_24

Fig. 24 - Typical Q_{rr} Antiparallel Diode vs. dI_F/dt
 $V_{rr} = 200$ V, $I_F = 4$ A

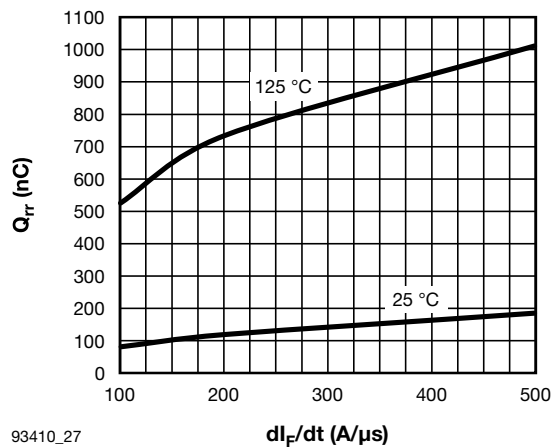

93410_27

Fig. 27 - Typical Q_{rr} Chopper Diode vs. dI_F/dt , $V_{rr} = 200$ V, $I_F = 40$ A

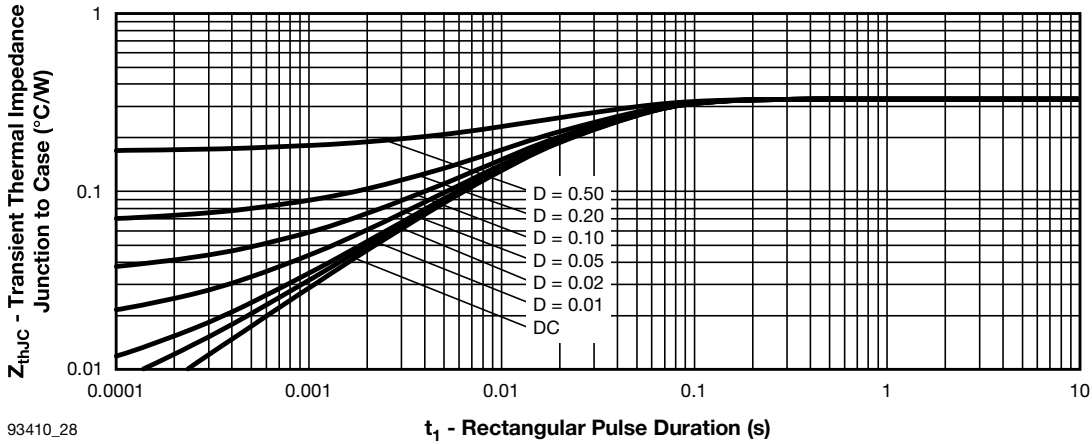

93410_28

Fig. 28 - Maximum Thermal Impedance Z_{thJC} Characteristics (IGBT)

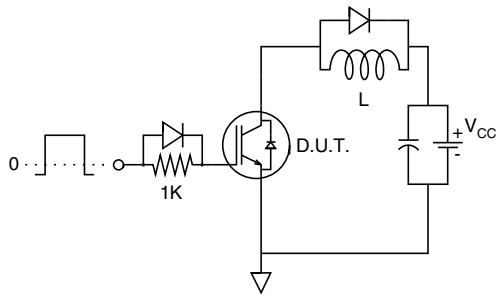

Fig. C.T.1 - Gate Charge Circuit (Turn-Off)

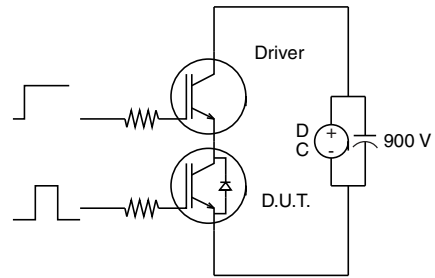

Fig. C.T.3 - S.C. SOA Circuit

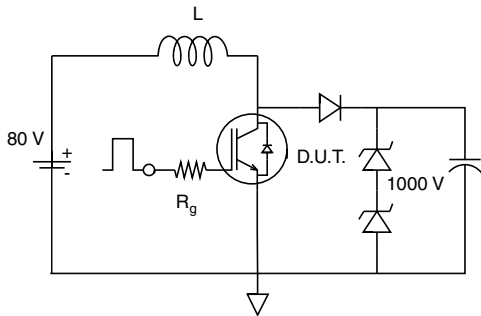

Fig. C.T.2 - RBSOA Circuit

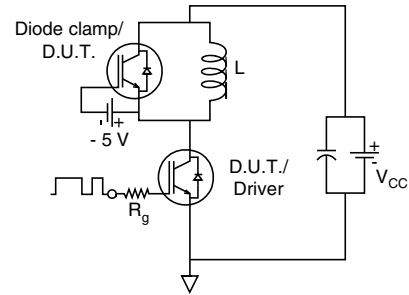

Fig. C.T.4 - Switching Loss Circuit

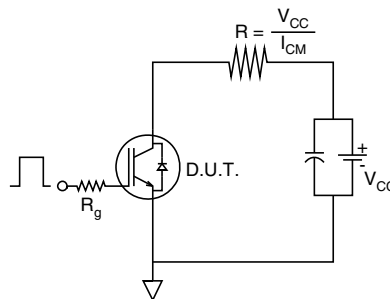
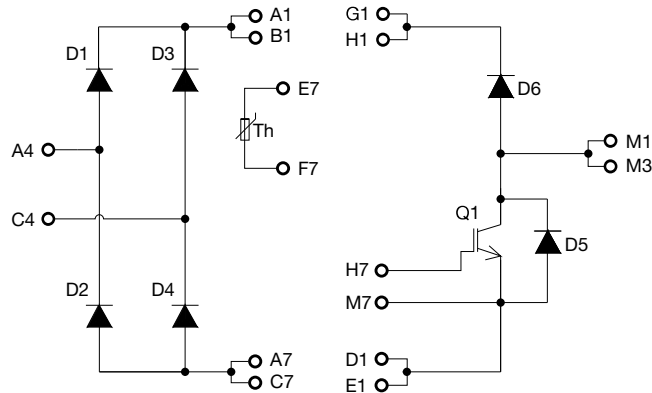

Fig. C.T.5 - Resistive Load Circuit

CIRCUIT CONFIGURATION



ORDERING INFORMATION

Device code

VS-	70	MT	060	W	SP
①	②	③	④	⑤	⑥

- 1** - Vishay Semiconductors product
- 2** - Current rating (70 = 70 A)
- 3** - Essential part number (MT = MTP package)
- 4** - Voltage code (060 = 600 V)
- 5** - Die IGBT technology (W = Warp Speed IGBT)
- 6** - Circuit configuration (SP = Single Phase Bridge plus PFC)

LINKS TO RELATED DOCUMENTS

Dimensions	www.vishay.com/doc?95383
------------	--



MTP - Full Pin

DIMENSIONS in millimeters

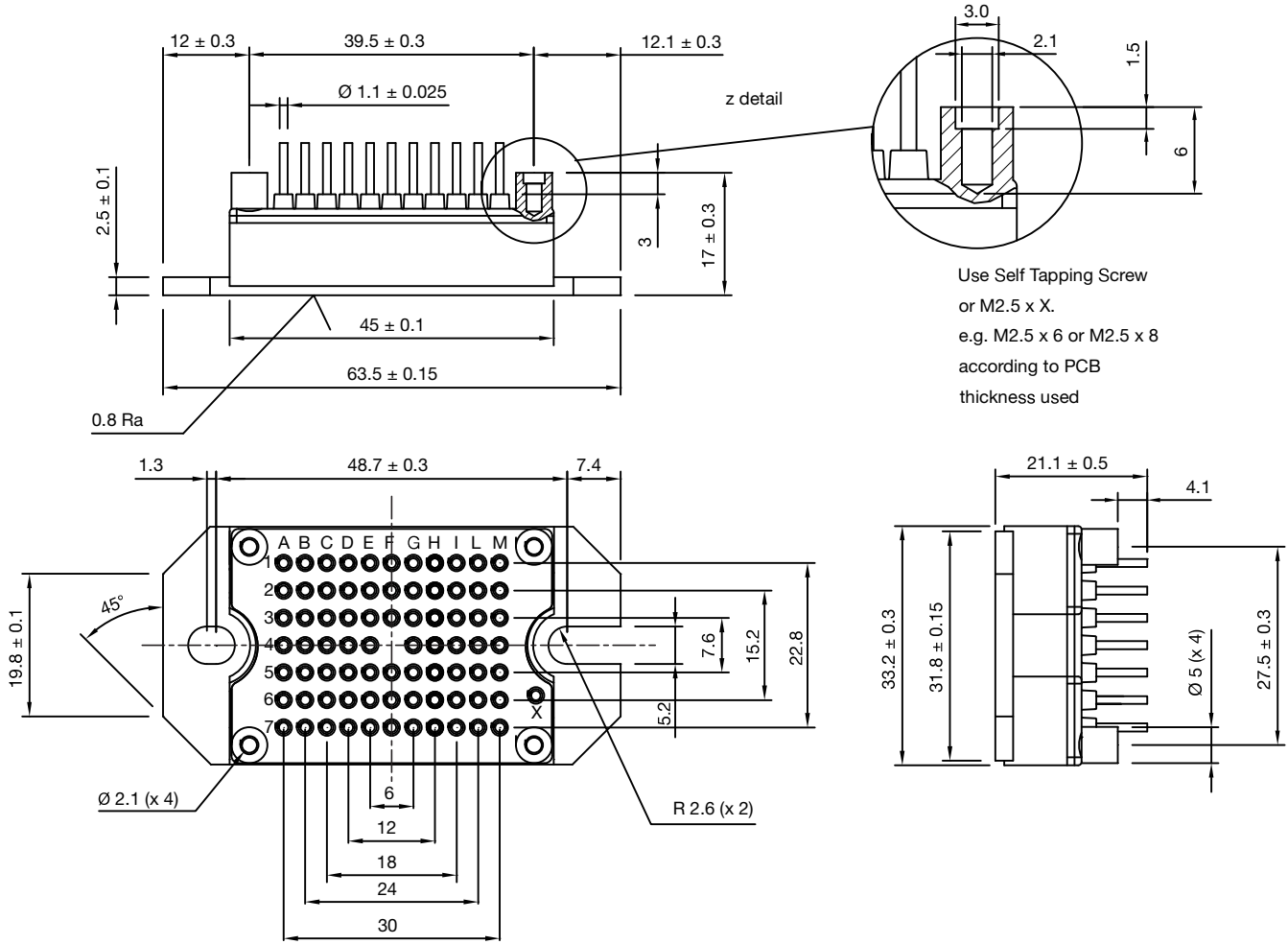

Use Self Tapping Screw
or M2.5 x X.
e.g. M2.5 x 6 or M2.5 x 8
according to PCB
thickness used

PINS POSITION
WITH TOLERANCE $\varnothing 0.6$



Disclaimer

ALL PRODUCT, PRODUCT SPECIFICATIONS AND DATA ARE SUBJECT TO CHANGE WITHOUT NOTICE TO IMPROVE RELIABILITY, FUNCTION OR DESIGN OR OTHERWISE.

Vishay Intertechnology, Inc., its affiliates, agents, and employees, and all persons acting on its or their behalf (collectively, "Vishay"), disclaim any and all liability for any errors, inaccuracies or incompleteness contained in any datasheet or in any other disclosure relating to any product.

Vishay makes no warranty, representation or guarantee regarding the suitability of the products for any particular purpose or the continuing production of any product. To the maximum extent permitted by applicable law, Vishay disclaims (i) any and all liability arising out of the application or use of any product, (ii) any and all liability, including without limitation special, consequential or incidental damages, and (iii) any and all implied warranties, including warranties of fitness for particular purpose, non-infringement and merchantability.

Statements regarding the suitability of products for certain types of applications are based on Vishay's knowledge of typical requirements that are often placed on Vishay products in generic applications. Such statements are not binding statements about the suitability of products for a particular application. It is the customer's responsibility to validate that a particular product with the properties described in the product specification is suitable for use in a particular application. Parameters provided in datasheets and / or specifications may vary in different applications and performance may vary over time. All operating parameters, including typical parameters, must be validated for each customer application by the customer's technical experts. Product specifications do not expand or otherwise modify Vishay's terms and conditions of purchase, including but not limited to the warranty expressed therein.

Except as expressly indicated in writing, Vishay products are not designed for use in medical, life-saving, or life-sustaining applications or for any other application in which the failure of the Vishay product could result in personal injury or death. Customers using or selling Vishay products not expressly indicated for use in such applications do so at their own risk. Please contact authorized Vishay personnel to obtain written terms and conditions regarding products designed for such applications.

No license, express or implied, by estoppel or otherwise, to any intellectual property rights is granted by this document or by any conduct of Vishay. Product names and markings noted herein may be trademarks of their respective owners.