

MOSFET - Power, Single N-Channel SuperFET[®] V, FRFET[®], D²PAK

600 V, 55 mΩ, 45 A

NVB055N60S5F

Description

The SUPERFET V MOSFET FRFET series has optimized body diode performance characteristics. This can allow for the removal of components in the application and improve application performance and reliability, particularly when soft switching topologies are used.

Features

- 650 V @ $T_J = 150^\circ\text{C}$ / Typ. $R_{DS(on)} = 44\text{ m}\Omega$
- 100% Avalanche Tested
- Pb-Free, Halogen Free/BFR Free and are RoHS Compliant

Applications

- Electric Vehicle On Board Chargers
- EV Main Battery DC/DC Converters

MAXIMUM RATINGS ($T_J = 25^\circ\text{C}$ unless otherwise noted)

Parameter	Symbol	Value	Unit	
Drain-to-Source Voltage	V_{DSS}	600	V	
Gate-to-Source Voltage	V_{GS}	DC	± 30	V
		AC ($f > 1\text{ Hz}$)	± 30	
Continuous Drain Current	I_D	$T_C = 25^\circ\text{C}$	45	A
		$T_C = 100^\circ\text{C}$	28	
Power Dissipation	P_D	278	W	
Pulsed Drain Current	I_{DM}	159	A	
Pulsed Source Current (Body Diode)	I_{SM}	159		
		$T_C = 25^\circ\text{C}$, $t_p = 10\text{ }\mu\text{s}$		
Operating Junction and Storage Temperature Range	T_J, T_{stg}	-55 to +150	$^\circ\text{C}$	
Source Current (Body Diode)	I_S	45	A	
Single Pulse Avalanche Energy	E_{AS}	417	mJ	
		($I_L = 7\text{ A}$, $R_G = 25\text{ }\Omega$)		
Avalanche Current	I_{AS}	7	A	
Repetitive Avalanche Energy (Note 1)	E_{AR}	2.78	mJ	
MOSFET dv/dt	dvdt	120	V/ns	
Peak Diode Recovery dv/dt (Note 2)		70		
Lead Temperature for Soldering Purposes (1/8" from case for 10 s)	T_L	260	$^\circ\text{C}$	

Stresses exceeding those listed in the Maximum Ratings table may damage the device. If any of these limits are exceeded, device functionality should not be assumed, damage may occur and reliability may be affected.

1. Repetitive rating: pulse-width limited by maximum junction temperature.
2. $I_{SD} \leq 22.5\text{ A}$, $di/dt \leq 200\text{ A}/\mu\text{s}$, $V_{DD} \leq 400\text{ V}$, starting $T_J = 25^\circ\text{C}$.

V_{DSS}	$R_{DS(ON)}\text{ MAX}$	$I_D\text{ MAX}$
600 V	55 mΩ @ 10 V	45 A

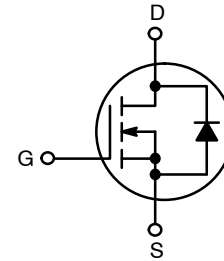

POWER MOSFET

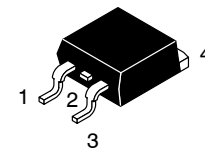

D²PAK
CASE 418AJ

MARKING DIAGRAM

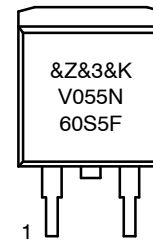

- &Z = Assembly Plant Code
- &3 = Date Code (Year & Week)
- &K = Assembly Lot
- V055N60S5F = Specific Device Code

ORDERING INFORMATION

See detailed ordering and shipping information on page 2 of this data sheet.

NVB055N60S5F

THERMAL RESISTANCE

Parameter	Symbol	Value	Unit
Thermal Resistance, Junction-to-Case, Max.	$R_{\theta JC}$	0.45	°C/W
Thermal Resistance, Junction-to-Ambient, Max.	$R_{\theta JA}$	62.5	

ELECTRICAL CHARACTERISTICS ($T_J = 25^\circ\text{C}$ unless otherwise noted)

Parameter	Symbol	Test Conditions	Min	Typ	Max	Unit
-----------	--------	-----------------	-----	-----	-----	------

OFF CHARACTERISTICS

Drain-to-Source Breakdown Voltage	$V_{(BR)DSS}$	$V_{GS} = 0\text{ V}, I_D = 1\text{ mA}, T_J = 25^\circ\text{C}$	600	-	-	V
Drain-to-Source Breakdown Voltage Temperature Coefficient	$\Delta V_{(BR)DSS} / \Delta T_J$	$I_D = 10\text{ mA}$, Referenced to 25°C	-	581	-	mV/°C
Zero Gate Voltage Drain Current	I_{DSS}	$V_{GS} = 0\text{ V}, V_{DS} = 600\text{ V}, T_J = 25^\circ\text{C}$	-	-	10	μA
Gate-to-Source Leakage Current	I_{GSS}	$V_{GS} = \pm 30\text{ V}, V_{DS} = 0\text{ V}$	-	-	±100	nA

ON CHARACTERISTICS

Drain-to-Source On Resistance	$R_{DS(on)}$	$V_{GS} = 10\text{ V}, I_D = 22.5\text{ A}, T_J = 25^\circ\text{C}$	-	44	55	mΩ
Gate Threshold Voltage	$V_{GS(th)}$	$V_{GS} = V_{DS}, I_D = 5.2\text{ mA}, T_J = 25^\circ\text{C}$	3.2	-	4.8	V
Forward Trans-conductance	g_{FS}	$V_{DS} = 20\text{ V}, I_D = 22.5\text{ A}$	-	44.8	-	S

CHARGES, CAPACITANCES & GATE RESISTANCE

Input Capacitance	C_{ISS}	$V_{DS} = 400\text{ V}, V_{GS} = 0\text{ V}, f = 250\text{ kHz}$	-	4603	-	pF
Output Capacitance	C_{OSS}		-	72.9	-	
Time Related Output Capacitance	$C_{OSS(tr)}$	$I_D = \text{Constant}, V_{DS} = 0\text{ V to } 400\text{ V}, V_{GS} = 0\text{ V}$	-	1114	-	pF
Energy Related Output Capacitance	$C_{OSS(er)}$		$V_{DS} = 0\text{ V to } 400\text{ V}, V_{GS} = 0\text{ V}$	-	125	
Total Gate Charge	$Q_{G(tot)}$	$V_{DD} = 400\text{ V}, I_D = 22.5\text{ A}, V_{GS} = 10\text{ V}$	-	85.2	-	nC
Gate-to-Source Charge	Q_{GS}		-	26.2	-	
Gate-to-Drain Charge	Q_{GD}		-	24.9	-	
Gate Resistance	R_G		$f = 1\text{ MHz}$	-	4.32	

SWITCHING CHARACTERISTICS

Turn-On Delay Time	$t_{d(on)}$	$V_{GS} = 0/10\text{ V}, V_{DD} = 400\text{ V}, I_D = 22.5\text{ A}, R_G = 4.7\text{ }\Omega$	-	44	-	ns
Rise Time	t_r		-	26.2	-	
Turn-Off Delay Time	$t_{d(off)}$		-	108	-	
Fall Time	t_f		-	2.6	-	

SOURCE-TO-DRAIN DIODE CHARACTERISTICS

Forward Diode Voltage	V_{SD}	$V_{GS} = 0\text{ V}, I_{SD} = 22.5\text{ A}, T_J = 25^\circ\text{C}$	-	-	1.2	V
Reverse Recovery Time	t_{RR}	$V_{GS} = 0\text{ V}, I_{SD} = 22.5\text{ A}, di/dt = 100\text{ A}/\mu\text{s}, V_{DD} = 400\text{ V}$	-	128	-	ns
Reverse Recovery Charge	Q_{RR}		-	758	-	nC

Product parametric performance is indicated in the Electrical Characteristics for the listed test conditions, unless otherwise noted. Product performance may not be indicated by the Electrical Characteristics if operated under different conditions.

PACKAGE MARKING AND ORDERING INFORMATION

Part Number	Top Marking	Package	Packing Method	Reel Size	Tape Width	Quantity
NVB055N60S5F	V055N60S5F	D ² PAK	Tape & Reel†	330 mm	24 mm	800 Units

†For information on tape and reel specifications, including part orientation and tape sizes, please refer to our Tape and Reel Packaging Specifications Brochure, [BRD8011/D](#).

TYPICAL CHARACTERISTICS

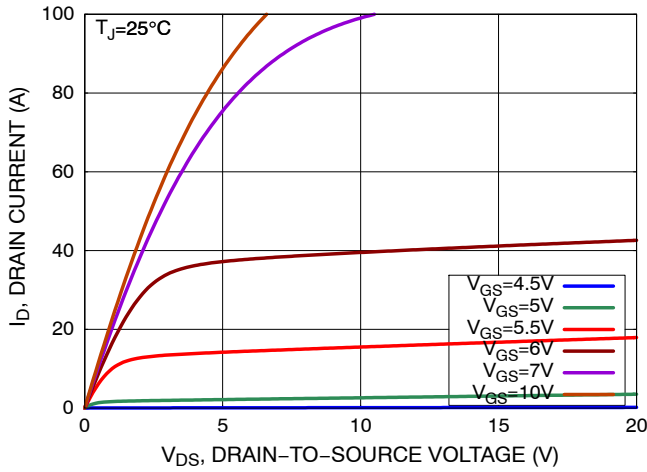

Figure 1. On-Region Characteristics

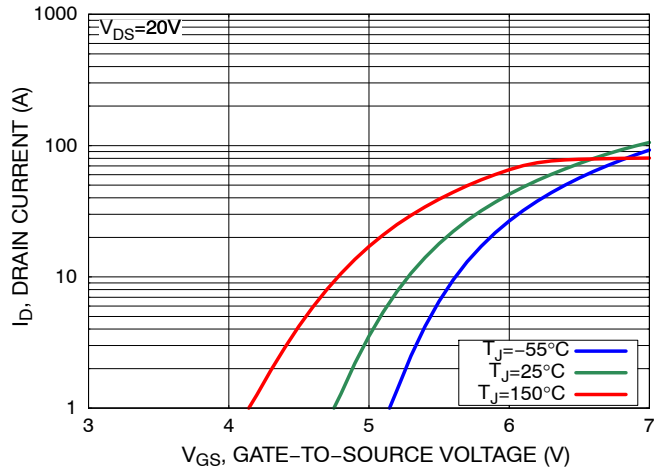

Figure 2. Transfer Characteristics

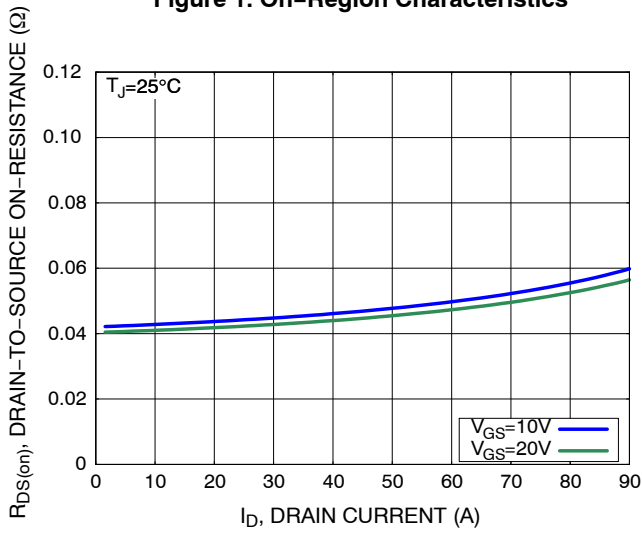

Figure 3. On-Resistance Variation vs. Drain Current and Gate Voltage

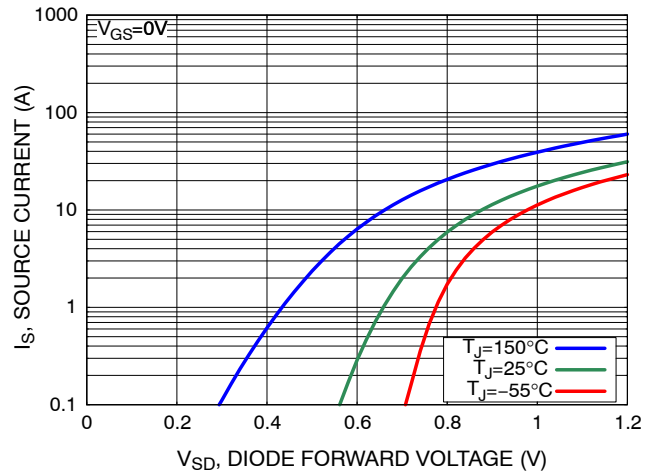

Figure 4. Diode Forward Voltage vs. Source Current

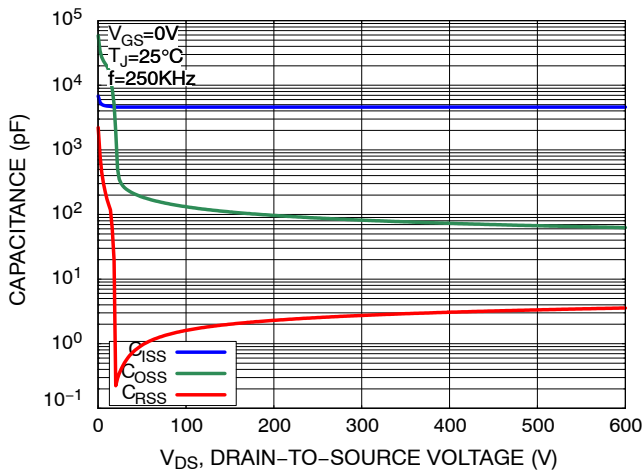

Figure 5. Capacitance Characteristics

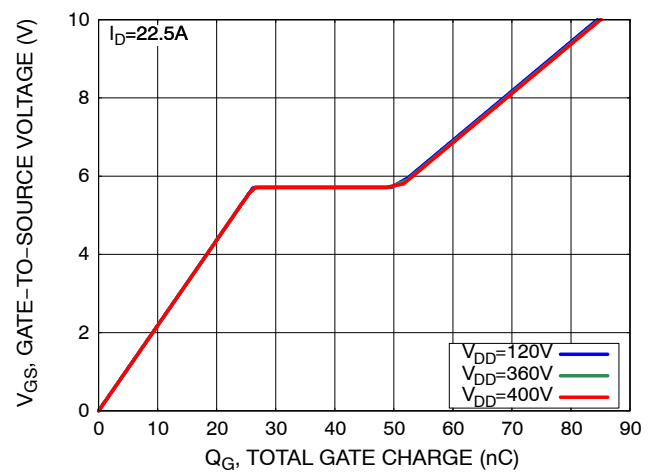

Figure 6. Gate Charge Characteristics

NVB055N60S5F

TYPICAL CHARACTERISTICS

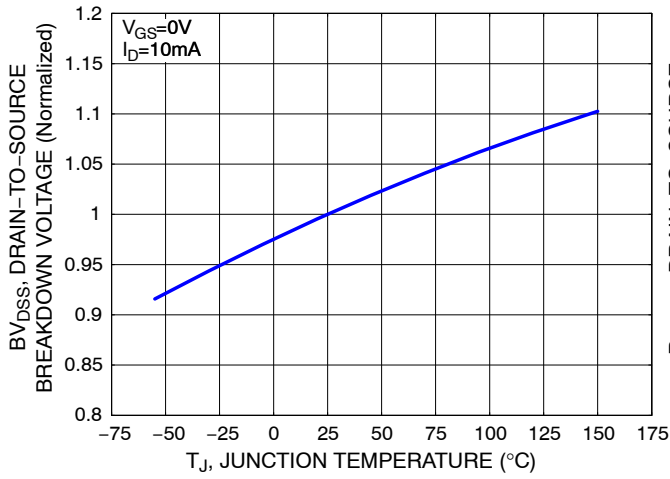

Figure 7. Breakdown Voltage Variation vs. Temperature

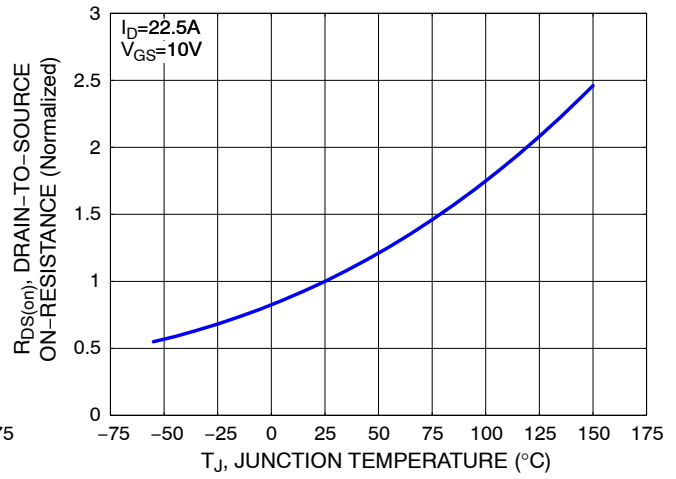

Figure 8. On-Resistance Variation vs. Temperature

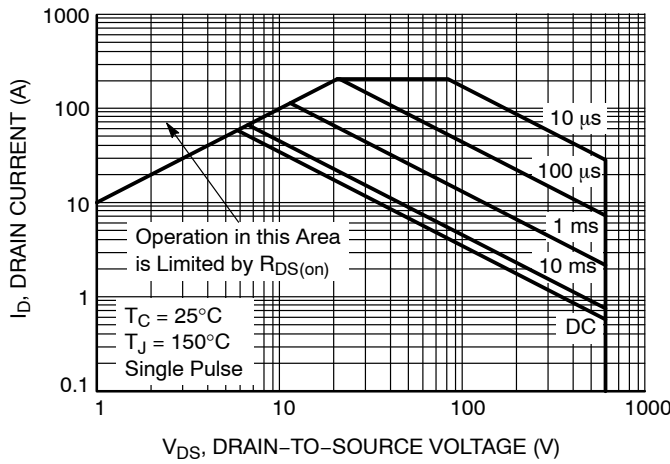

Figure 9. Maximum Safe Operating Area

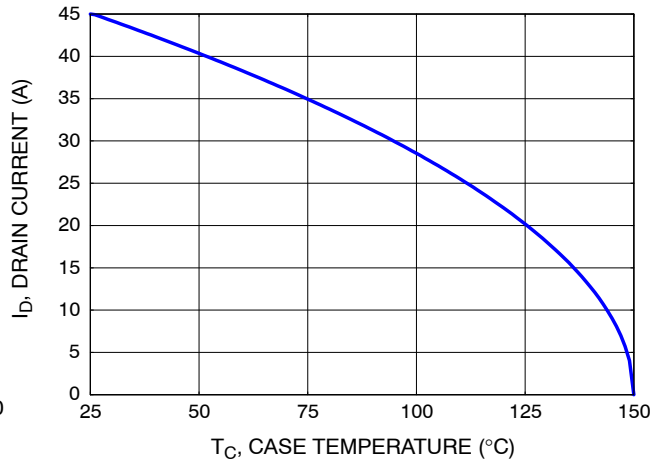

Figure 10. Maximum Drain Current vs. Case Temperature

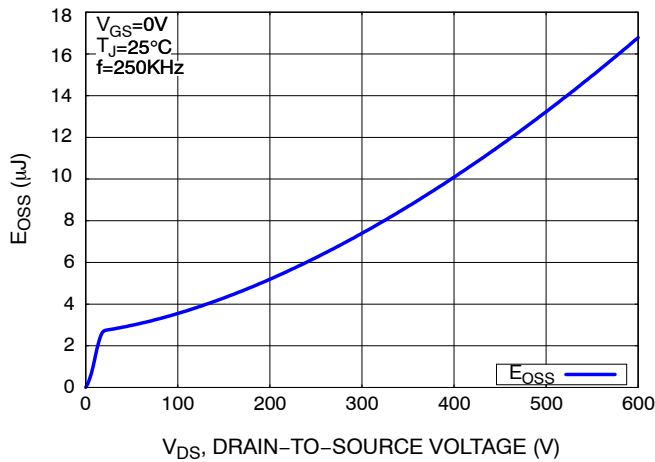

Figure 11. E_{OSS} vs. Drain-to-Source Voltage

NVB055N60S5F

TYPICAL CHARACTERISTICS

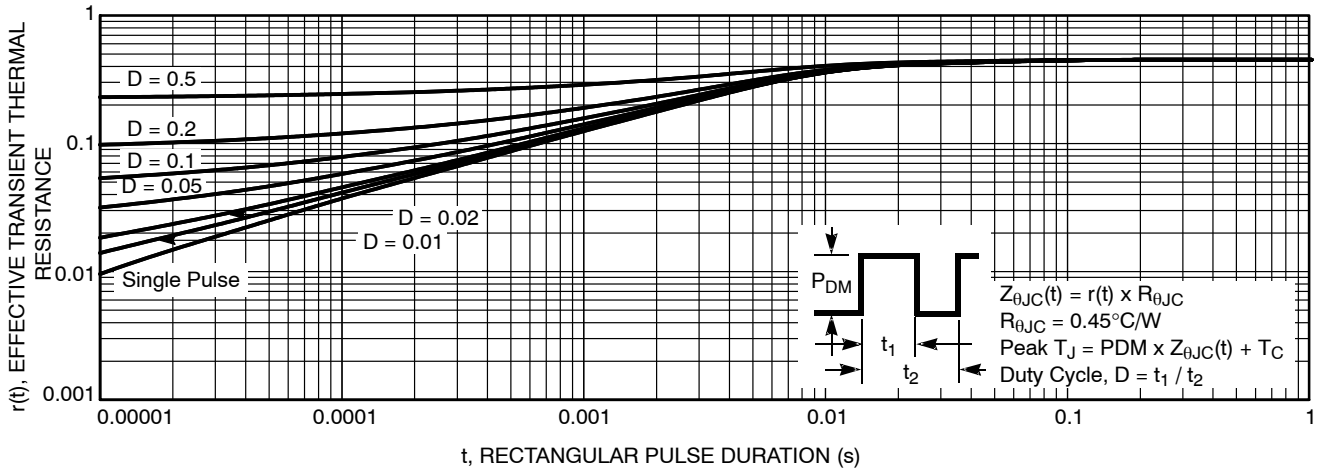

Figure 12. Transient Thermal Impedance

NVB055N60S5F

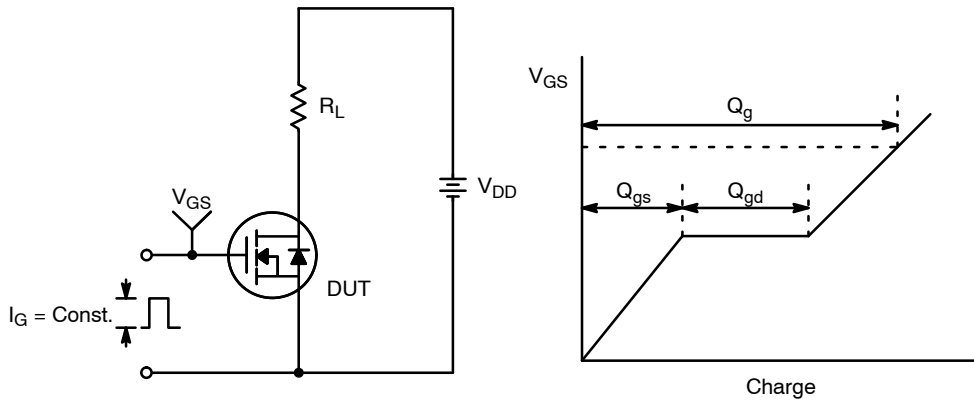

Figure 13. Gate Charge Test Circuit & Waveform

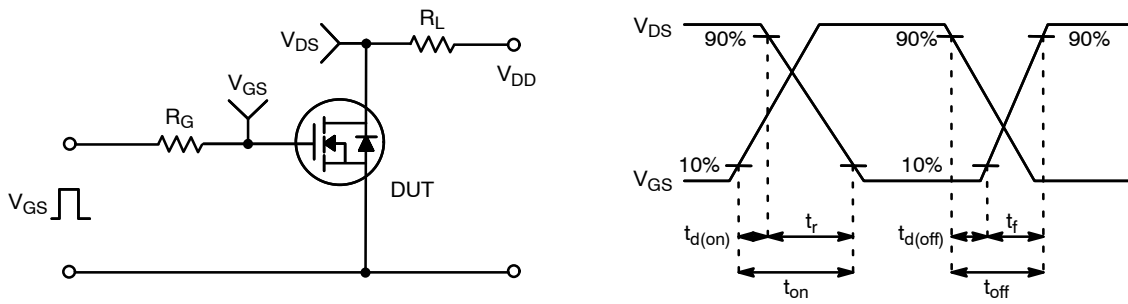

Figure 14. Resistive Switching Test Circuit & Waveforms

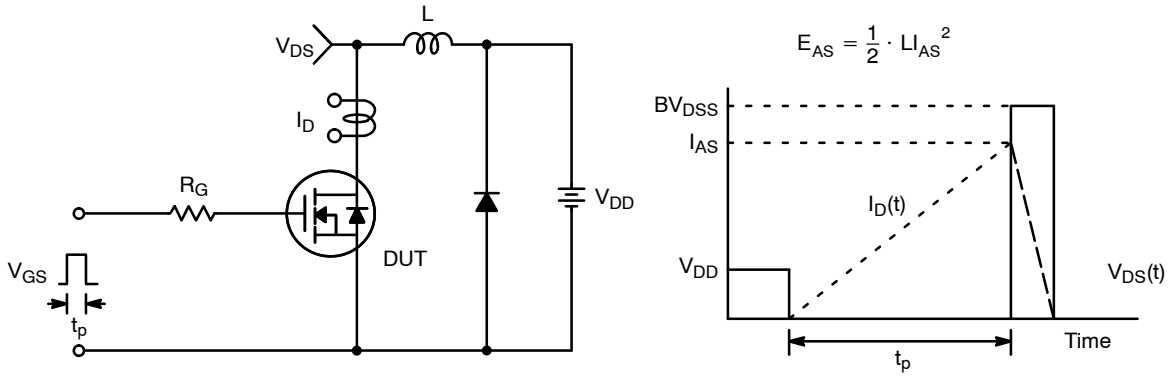

Figure 15. Unclamped Inductive Switching Test Circuit & Waveforms

NVB055N60S5F

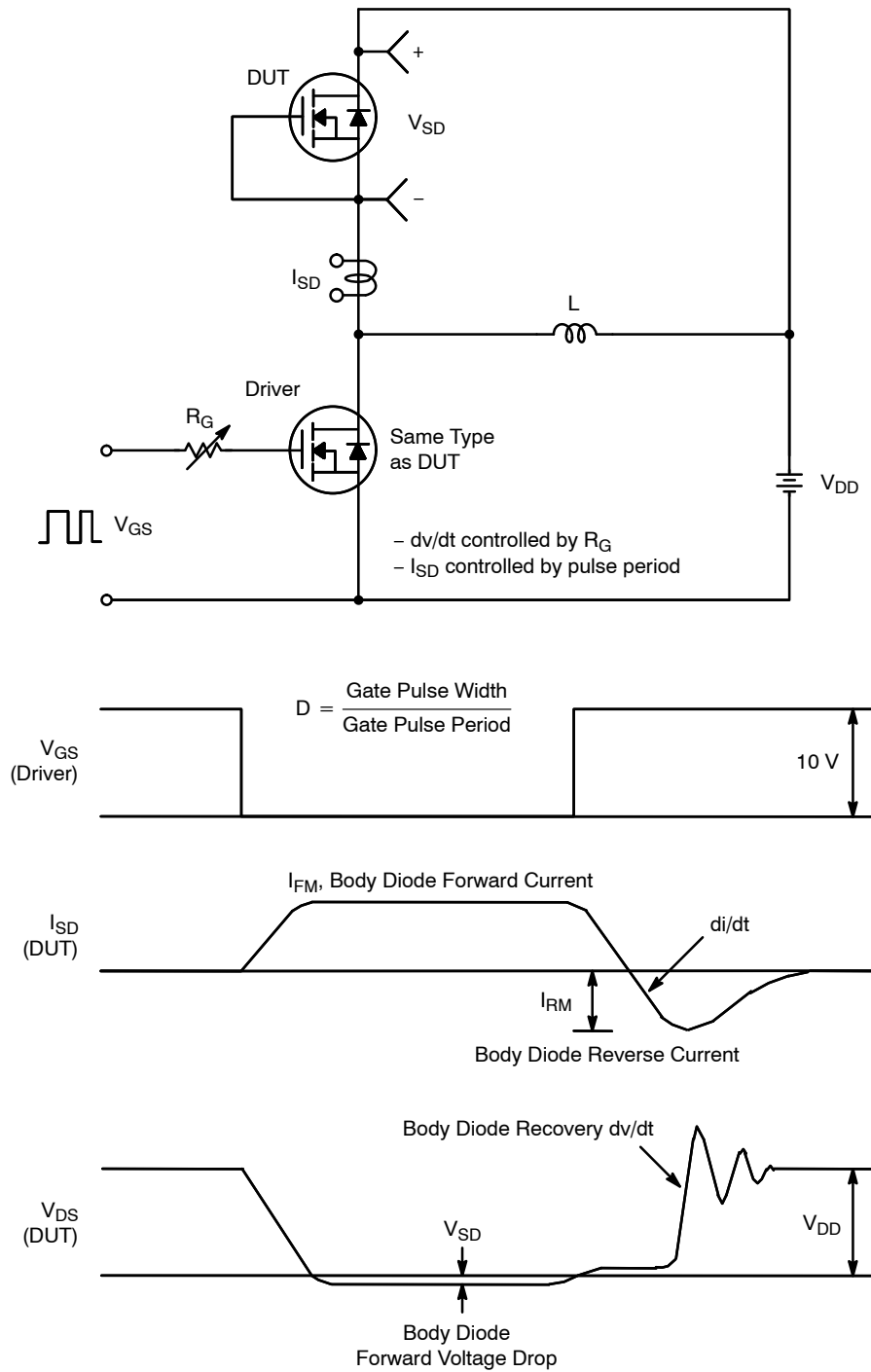
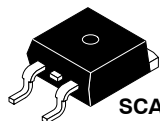

Figure 16. Peak Diode Recovery dv/dt Test Circuit & Waveforms

MECHANICAL CASE OUTLINE

PACKAGE DIMENSIONS

ON Semiconductor®



SCALE 1:1

D²PAK-3 (TO-263, 3-LEAD)

CASE 418AJ

ISSUE F

DATE 11 MAR 2021

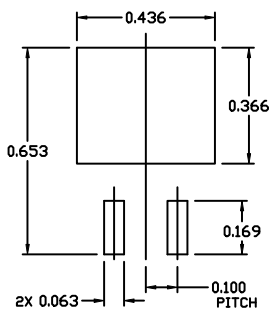

RECOMMENDED MOUNTING FOOTPRINT

■ For additional information on our Pb-Free strategy and soldering details, please download the ON Semiconductor Soldering and Mounting Techniques Reference Manual, SOLDERRM/D.

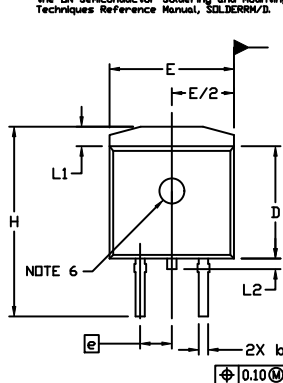

NOTES:

- DIMENSIONING AND TOLERANCING PER ASME Y14.5M, 2009.
- CONTROLLING DIMENSION: INCHES
- CHAMFER OPTIONAL.
- DIMENSIONS D AND E DO NOT INCLUDE MOLD FLASH. MOLD FLASH SHALL NOT EXCEED 0.005 PER SIDE. THESE DIMENSIONS ARE MEASURED AT THE OUTERMOST EXTREMES OF THE PLASTIC BODY AT DATUM H.
- THERMAL PAD CONTOUR IS OPTIONAL WITHIN DIMENSIONS E, L1, D1, AND E1.
- OPTIONAL MOLD FEATURE.
- ①, ② ... OPTIONAL CONSTRUCTION FEATURE CALL OUTS.

DIM	INCHES		MILLIMETERS	
	MIN.	MAX.	MIN.	MAX.
A	0.160	0.190	4.06	4.83
A1	0.000	0.010	0.00	0.25
b	0.020	0.039	0.51	0.99
c	0.012	0.029	0.30	0.74
c2	0.045	0.065	1.14	1.65
D	0.330	0.380	8.38	9.65
D1	0.260	---	6.60	---
E	0.380	0.420	9.65	10.67
E1	0.245	---	6.22	---
e	0.100	BSC	2.54	BSC
H	0.575	0.625	14.60	15.88
L	0.070	0.110	1.78	2.79
L1	---	0.066	---	1.68
L2	---	0.070	---	1.78
L3	0.010	BSC	0.25	BSC
M	0*	8*	0*	8*

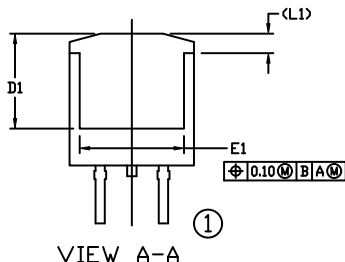
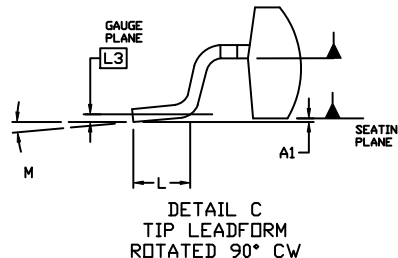
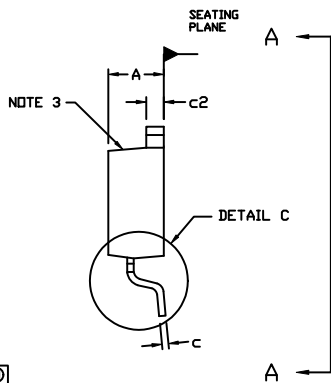

VIEW A-A

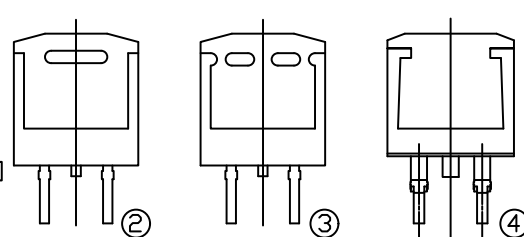

VIEW A-A
OPTIONAL CONSTRUCTIONS

GENERIC MARKING DIAGRAMS*

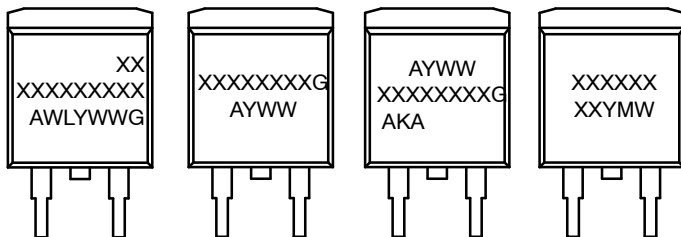

IC

Standard

Rectifier

SSG

- XXXXXX = Specific Device Code
- A = Assembly Location
- WL = Wafer Lot
- Y = Year
- WW = Work Week
- W = Week Code (SSG)
- M = Month Code (SSG)
- G = Pb-Free Package
- AKA = Polarity Indicator

*This information is generic. Please refer to device data sheet for actual part marking. Pb-Free indicator, "G" or microdot "▪", may or may not be present. Some products may not follow the Generic Marking.

DOCUMENT NUMBER:	98AON56370E	Electronic versions are uncontrolled except when accessed directly from the Document Repository. Printed versions are uncontrolled except when stamped "CONTROLLED COPY" in red.
DESCRIPTION:	D ² PAK-3 (TO-263, 3-LEAD)	PAGE 1 OF 1

ON Semiconductor and ON are trademarks of Semiconductor Components Industries, LLC dba ON Semiconductor or its subsidiaries in the United States and/or other countries. ON Semiconductor reserves the right to make changes without further notice to any products herein. ON Semiconductor makes no warranty, representation or guarantee regarding the suitability of its products for any particular purpose, nor does ON Semiconductor assume any liability arising out of the application or use of any product or circuit, and specifically disclaims any and all liability, including without limitation special, consequential or incidental damages. ON Semiconductor does not convey any license under its patent rights nor the rights of others.

onsemi, **Onsemi**, and other names, marks, and brands are registered and/or common law trademarks of Semiconductor Components Industries, LLC dba "**onsemi**" or its affiliates and/or subsidiaries in the United States and/or other countries. **onsemi** owns the rights to a number of patents, trademarks, copyrights, trade secrets, and other intellectual property. A listing of **onsemi**'s product/patent coverage may be accessed at www.onsemi.com/site/pdf/Patent-Marking.pdf. **onsemi** reserves the right to make changes at any time to any products or information herein, without notice. The information herein is provided "as-is" and **onsemi** makes no warranty, representation or guarantee regarding the accuracy of the information, product features, availability, functionality, or suitability of its products for any particular purpose, nor does **onsemi** assume any liability arising out of the application or use of any product or circuit, and specifically disclaims any and all liability, including without limitation special, consequential or incidental damages. Buyer is responsible for its products and applications using **onsemi** products, including compliance with all laws, regulations and safety requirements or standards, regardless of any support or applications information provided by **onsemi**. "Typical" parameters which may be provided in **onsemi** data sheets and/or specifications can and do vary in different applications and actual performance may vary over time. All operating parameters, including "Typicals" must be validated for each customer application by customer's technical experts. **onsemi** does not convey any license under any of its intellectual property rights nor the rights of others. **onsemi** products are not designed, intended, or authorized for use as a critical component in life support systems or any FDA Class 3 medical devices or medical devices with a same or similar classification in a foreign jurisdiction or any devices intended for implantation in the human body. Should Buyer purchase or use **onsemi** products for any such unintended or unauthorized application, Buyer shall indemnify and hold **onsemi** and its officers, employees, subsidiaries, affiliates, and distributors harmless against all claims, costs, damages, and expenses, and reasonable attorney fees arising out of, directly or indirectly, any claim of personal injury or death associated with such unintended or unauthorized use, even if such claim alleges that **onsemi** was negligent regarding the design or manufacture of the part. **onsemi** is an Equal Opportunity/Affirmative Action Employer. This literature is subject to all applicable copyright laws and is not for resale in any manner.

ADDITIONAL INFORMATION

TECHNICAL PUBLICATIONS:

Technical Library: www.onsemi.com/design/resources/technical-documentation
onsemi Website: www.onsemi.com

ONLINE SUPPORT: www.onsemi.com/support

For additional information, please contact your local Sales Representative at www.onsemi.com/support/sales