

4

3

2

1

THIS DRAWING IS UNPUBLISHED. RELEASED FOR PUBLICATION 2009

© COPYRIGHT 2009 BY TYCO ELECTRONICS CORPORATION. ALL RIGHTS RESERVED.

LOC		DIST		REVISIONS			
P	LTR	DESCRIPTION		DATE	DWN	APVD	
	BA	NEW RELEASE		29-SEP-09	MRS	St.P	

FOR FURTHER INFORMATION SEE DATA SHEET FOR SERIES LR, METAL FILM FIXED RESISTORS

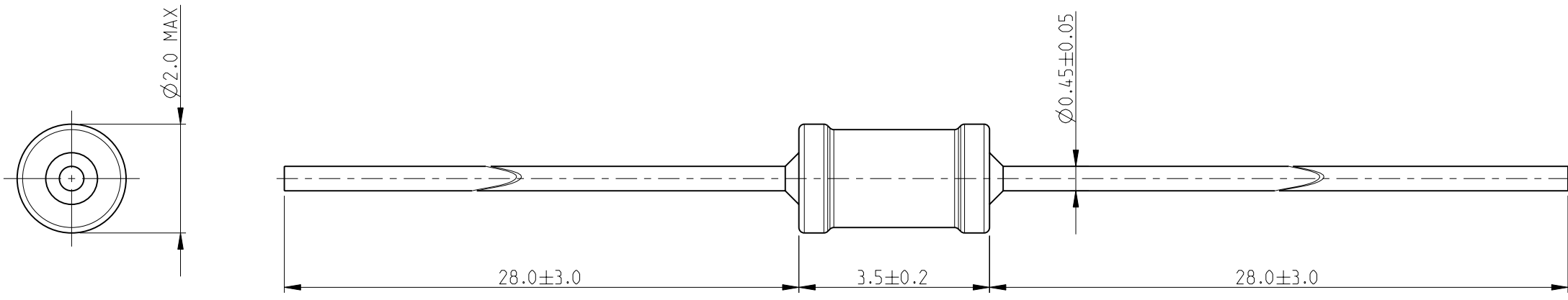

RoHS Compliant



<small>THIS DRAWING IS A CONTROLLED DOCUMENT FOR TYCO ELECTRONICS CORPORATION IT IS SUBJECT TO CHANGE AND THE CONTROLLING ENGINEERING ORGANIZATION SHOULD BE CONTACTED FOR THE LATEST REVISION.</small>		DWN MAHARUDRA 29-SEP-09 CHK ALLAN.P 29-SEP-09 APVD STEPHEN.P 29-SEP-09		Tyco Electronics Corporation Dorcan, Swindon, SN3 5HH	
DIMENSIONS: mm		TOLERANCES UNLESS OTHERWISE SPECIFIED: 0 PLC ± 0.2 1 PLC ± 0.1 2 PLC $\pm -$ 3 PLC $\pm -$ 4 PLC $\pm -$ ANGLES $\pm 5^\circ$		NAME METAL FILM FIXED RESISTORS SERIES LR0204	
MATERIAL -		FINISH -		PRODUCT SPEC - APPLICATION SPEC - WEIGHT -	
AMP 1470-19 REV 31MAR2000		CUSTOMER DRAWING		SIZE A3 CAGE CODE 00779 DRAWING NO C-1614986	RESTRICTED TO -
		SCALE 10:1		SHEET 1 OF 1 REV BA	