

DATASHEET

Multi-Channel Superluminescent Diode Source

Integrated Spectral Bench (ISB2)

Multi-SLED Light Source, 2 SLEDs: 1550nm, 1615nm, SM Fiber, Low Degree of Polarization, Spectral Coverage: 1530nm-1630nm, FWHM: 100nm, CW:1580nm, Light Output Power >10mW

Luxmux Part Number: ASM000720



A. PRODUCT DESCRIPTION

The Luxmux broadband multi-superluminescent diode source (Multi-SLED) ASM000720 combines two output beams as a single spectrum product. The system provides individual control of light sources through a digitally controlled interface. Individual SLED performance dashboards are provided for optimum set up calibration as required. The light source is integrated with a high-performance SLED driver and temperature control electronics in a rugged compact package. Power meters can be added for additional monitoring capability.

Luxmux's Spectral Stitching technique of integrating multiple wavelengths into a single broad spectrum is designed for optimum coupling efficiency into a single mode fiber. This brings exceptional flexibility and usability to the sensing marketplace. The Multi-SLED can be spectrally tailored to suit specific application needs and offer excellent back reflection immunity. This provides extremely high stability, making these sources ideal for the applications included below:

B. KEY FEATURES

- Two superluminescent diodes (SLEDs)
- All SLEDs can be run from 0 – 100% of maximum rating
- Fiber-coupled output power: >10mW
- Bandwidth FWHM > 100nm, @10dB > 170nm
- Under 5% degree of polarization (DOP) across the spectrum
- Luxmux's patented technology for spectral stitching provides optimum power and bandwidth
- Multiple communication interfaces: USB, RS-232, Ethernet
- Each SLED comes with a built-in independent monitor photodiode and one common thermoelectric cooler (TEC) for all SLEDs
- Internally optimized for maximum coupling efficiency with PM1550-XP Fiber or PM1300-XP
- Monolithic integration of a Broadband Dual Stage PMF Isolator (35dB)
- Light output: FC/APC Connector (Optional FC/PC or SMA)
- User friendly GUI and custom API available for test automation

C. APPLICATIONS

- Optical Component Testing
- Telecom Test Equipment
- Medical Optical Coherence Tomography
- Industrial Optical Coherence Tomography
- Metrology
- Biomedical Imaging Systems
- Optical Sensing
- White Light Interferometry & Chromatic Dispersion
- Research and Development

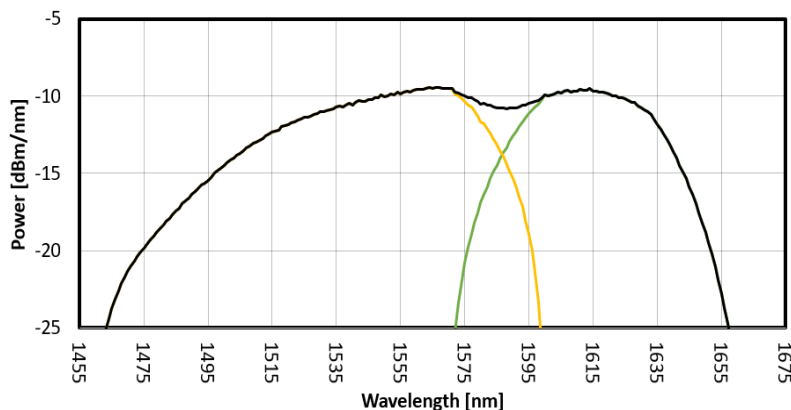

#LTC-ISB2-1550_1615-SM-LP-1530_1630-100-1580-10_DS_2021_08_05

This document is the property of Luxmux, and contains proprietary information. Luxmux reserves the right to make product design or specification changes without notice.



D. ABSOLUTE MAXIMUM RATINGS (see note 1)

Parameter	Symbol	Condition	Minimum	Maximum	Unit
DRIVER POWER SUPPLY SPECIFICATIONS					
Input Power Supply Voltage	V _s	CW	10	14	V
Input Power Supply Current	I _s	CW	5	-	A
TEMPERATURE SPECIFICATIONS					
Case Temperature (see note 2)	T _{Case}		0	60	°C
Storage Temperature (see note 4)	T _{stg}	No condensation, Unbiased	-40	85	°C
Storage Humidity (see note 4)	RH _{stg}		5	85	%RH
Ambient Operating Temperature (See note 3)	T _{OP}		0	50	°C

Notes:

1. Please note that exceeding the Absolute Maximum Ratings above may cause device failure. Luxmux does not bear responsibility for laser power damage that is attributed to electrostatic discharge, excessive current levels, and current spikes (transients). Any attempts to increase the laser drive current above the pre-set limits or recommended specification limits, can damage the device, and nullify the warranty period. It should be emphasized that the current limit set points cannot be exceeded.
2. T_{Case} and T_{TEC} are monitored by internal thermistor with external readout.
3. For optimum performance of the Integrated Spectral Bench (ISB2), the ISB2 must be operated within the specified temperature ranges. The Multi-SLED® has an internal thermoelectric cooler (TEC) to remove heat from the light source and dissipate it through the ISB2 case. It is required to provide free air circulation around the ISB2 device. It is always recommended to cool down the unit with a fan, and/or to mount the ISB2 on an appropriate heatsink, capable of dissipating up to 15W. The thermal resistance between ISB2 metal case and heatsink can be minimized by applying thermal grease, thermal glue or thermal pad between the contact surfaces. **When the Multi-SLED® is used without a heatsink, maximum ambient operating temperature is 35°C.** The specification lists the operating temperature for the electrical/optical characteristics, which is the temperature of the ISB2 during the time that the specifications were measured. Variation in temperature beyond what is specified can have a significant effect on the optical characteristics, like changes in wavelength or drop in output power.
4. Storage temperature and relative humidity should be chosen so the dew point of the humid air around the package is below the storage temperature of the package, to avoid condensation inside the ISB2 enclosure.



E. OPTICAL AND ELECTRICAL SPECIFICATIONS (see note 5)

Parameter	Symbol	Condition	Minimum	Typical	Maximum	Unit
DRIVER POWER SUPPLY SPECIFICATIONS						
Input Power Supply Voltage	V _s	CW	10	12	14	V
Input Power Supply Current	I _s	CW	5	-	-	A
Input Power Supply Voltage Ripple and Noise	γ	CW	-	-	200	mVpp
OPTICAL SPECIFICATIONS						
Center Wavelength (see note 6) SLED 1 – 1615nm SLED 2 – 1550nm SLED 1+2 – 1580nm	CWL	CW T _{OP} = 25°C T _{TEC} = 21°C I _{OP}	1605 1540 1570	1615 1550 1580	1625 1560 1590	nm
PM Fiber Coupled Power (see note 7) SLED 1 – 1615nm SLED 2 – 1550nm SLED 1+2 – 1580nm	P	CW T _{OP} = 25°C T _{TEC} = 21°C I _{OP}	4 6 10	-	-	mW
Bandwidth FWHM (see note 8) SLED 1 – 1615nm SLED 2 – 1550nm SLED 1+2 – 1580nm	B _{FWHM}	CW T _{OP} = 25°C T _{TEC} = 21°C I _{OP}	-	45 65 100	-	nm
Bandwidth @ -10dB SLED 1 – 1615nm SLED 2 – 1550nm SLED 1+2 – 1580nm	B _{@10dB}	CW T _{OP} = 25°C T _{TEC} = 21°C I _{OP}	-	75 90 170	-	nm
Spectrum Ripple (see note 9)	R	CW T _{OP} = 25°C T _{TEC} = 21°C I _{OP}	< 0.15	< 0.30	< 0.45	dB
Spectral Coverage	SC	CW T _{OP} = 25°C T _{TEC} = 21°C I _{OP}	-	1530 - 1630	-	nm
Degree of Polarization (see note 10) SLED 1+2 – 1580nm	DOP	CW T _{OP} = 25°C T _{TEC} = 21°C I _{OP}	-	-	5	%
RIN	RIN	CW T _{OP} = 25°C T _{TEC} = 21°C I _{OP}	-	< -130	-	dB/Hz



Redefining Spectral Boundaries

Parameter	Symbol	Condition	Minimum	Typical	Maximum	Unit
Power Stability (After 1h warm up)	P _{STAB}	T _{OP} = 25°C ± 2.5	-	< 0.1	-	dB
Warmup Time	W	CW T _{OP} = 25°C T _{TEC} = 21°C I _{OP}	15	30	60	Min.
CONSTANT CURRENT MODE						
Operating Current SLED 1 – 1615nm SLED 2 – 1550nm	I _{OP}	CW T _{OP} = 25°C T _{TEC} = 21°C I _{OP}	-	-	300 500	mA
Current Setting Resolution	R _{IOP_SET}		-	-	0.1	mA
SLED Current Reading Resolution	R _{IOP_READ}		-	0.1	-	mA
MODULATION MODE						
Waveform			-	Square	-	
Modulation Frequency Range	f _{mod}		0.016	-	1000	Hz
Duty Cycle	D		10	50	90	%
INTERNAL MONITOR DIODE						
Monitor Diode Current Reading	I _{mon}		-	-	500	uA
Monitor Diode Current Reading Resolution	RES _{imon}		-	7.6	-	nA
LIGHT OUTPUT CONNECTOR						
Type of Fiber Connector			-	FC/PC, FC/APC, SMA	-	
SLED TEC SPECIFICATIONS						
SLED TEC Temperature Setpoint	T _{SLED_SET}		0	-	40	°C
SLED TEC Temperature Setpoint Resolution	R _{TSLED_SET}		-	0.1	-	°C
SLED TEC Temperature Reading	T _{SLED_READ}		-40	-	100	°C
SLED TEC Temperature Reading Resolution	R _{TSLED_READ}		-	0.1	-	°C
TEMPERATURE SPECIFICATIONS						
Heatsink Temperature Reading Range	T _{HS}		-40	-	100	°C
Heatsink Temperature Reading Resolution	R _{THS}		-	0.1	-	°C

#LTC-ISB2-1550_1615-SM-LP-1530_1630-100-1580-10_DS_2021_08_05

This document is the property of Luxmux, and contains proprietary information. Luxmux reserves the right to make product design or specification changes without notice.



Redefining Spectral Boundaries

Parameter	Symbol	Condition	Minimum	Typical	Maximum	Unit
POWER METER						
Spectral Response Range	λ_{PM}		900	-	1870	nm
Photosensitive Area	A_{PM}		-	$\Phi 1$	-	mm
Power Meter Current Reading	P_{PM}		50	-	-	μA
Peak Sensitivity Wavelength	λ_p		-	1750	-	nm
Photo Sensitivity	S	$\lambda = \lambda_p$	0.9	1.1	-	A/W
Typical Dark Current	I_D		-	1	10	nA
Detectivity	D^*	$\lambda = \lambda_p$	2×10^{12}	5.5×10^{12}	-	$cm^*Hz^{1/2}/W$
Noise Equivalent Power	NEP	$\lambda = \lambda_p$	-	1.5×10^{-14}	4×10^{-14}	$W/Hz^{1/2}$
POWER METER TEC SPECIFICATIONS						
Power Meter TEC Temperature Setpoint	T_{PM_SET}		-20	-	40	$^{\circ}C$
Power Meter TEC Temperature Setpoint Resolution	R_{TPM_SET}		-	0.1	-	$^{\circ}C$
Power Meter TEC Temperature Reading	T_{PM_READ}		-40	-	85	$^{\circ}C$
Power Meter TEC Temperature Reading Resolution	R_{TPM_READ}		-	0.1	-	$^{\circ}C$
Notes:						
5. <i>There may be differences in typical values of output power, power stability, wavelength and bandwidth, due to coupling efficiency. These values are references and there is no guarantee that each particular ISB2 module will have EXACTLY the typical values shown on the previous chart.</i>						
6. <i>Center Wavelength is defined as the center point of the 3dB bandwidth of each individual SLED.</i>						
7. <i>The ISB2 – Integrated Spectral Bench uses a Dual Stage Isolator for back reflection protection. Isolators are used to protect a source from back reflections or signals that may occur after the isolator. Back reflections can damage a laser source or cause it to amplitude modulate, or frequency shift. In high-power applications, back reflections can cause instabilities and power spikes. Luxmux does not bear responsibility for laser power damage that is attributed to hot spots in the beam.</i>						
8. <i>BeST-SLED® FWHM is defined as the bandwidth from the lowest spectral dip, when all the SLEDs are on.</i>						
9. <i>Resolution of 0.1nm. Figure of merit does not include dips between SLEDs.</i>						
10. <i>Degree of Polarization is defined as the ratio of optical powers of perpendicular polarizations, expressed in percentage (%).</i>						

F. PLOTS - Test performed at $T_{OP}=25^{\circ}C$ and $T_{TEC}=21^{\circ}C$

FIG. 1: ISB2 SPECTRUM

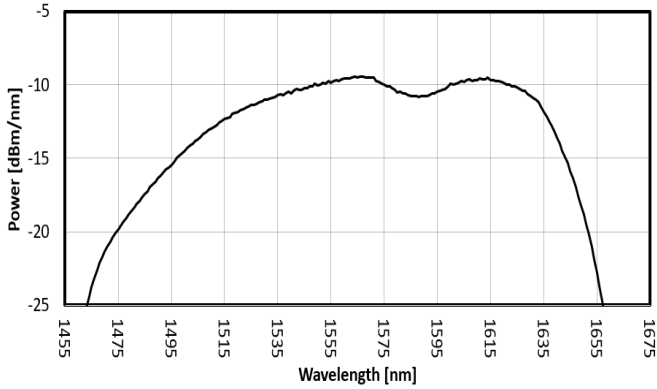

FIG. 2: SLED 1 SPECTRUM

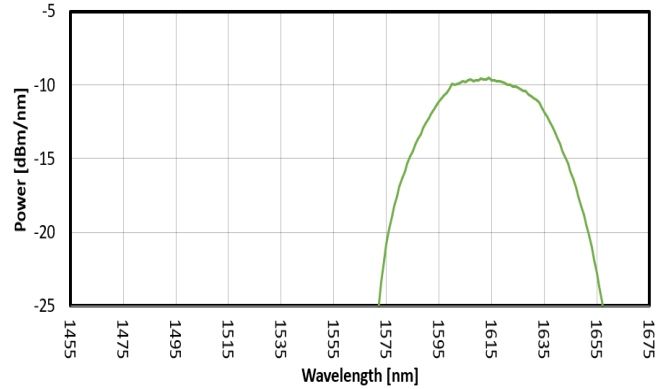

FIG. 3: SLED 2 SPECTRUM

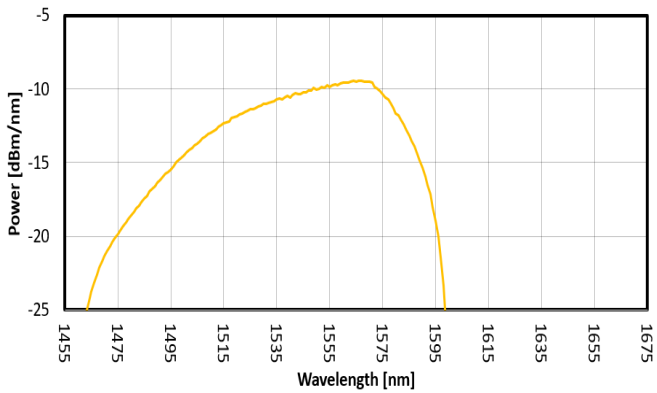

FIG. 4: SLED 1 OUTPUT POWER VS CURRENT

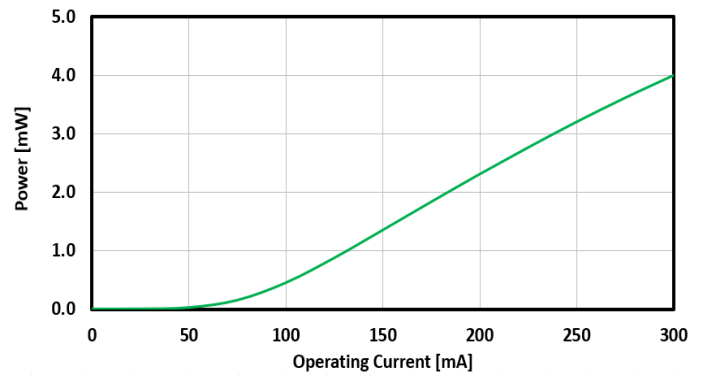

FIG. 5: SLED 2 OUTPUT POWER VS CURRENT

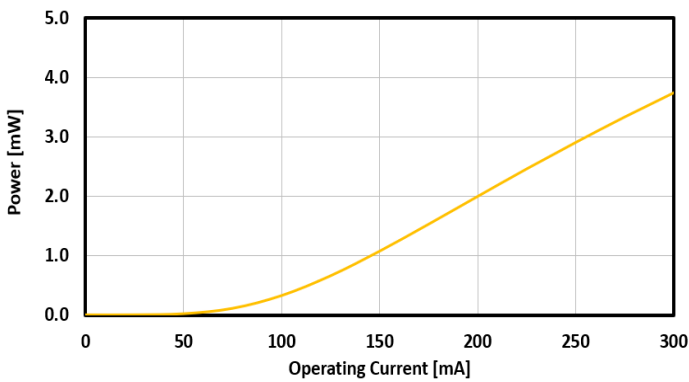

FIG. 6: ISB2 TYPICAL POWER STABILITY

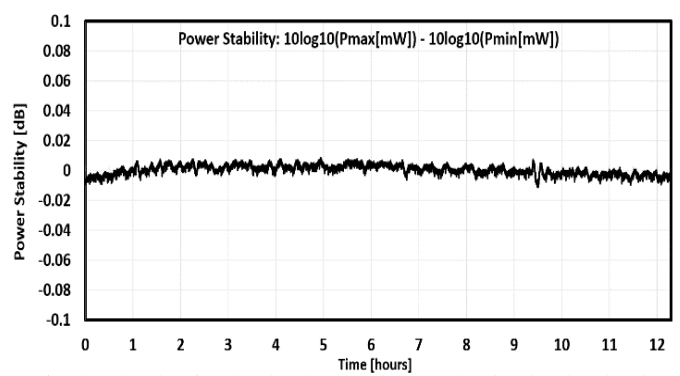

FIG. 7: WARM-UP TIME

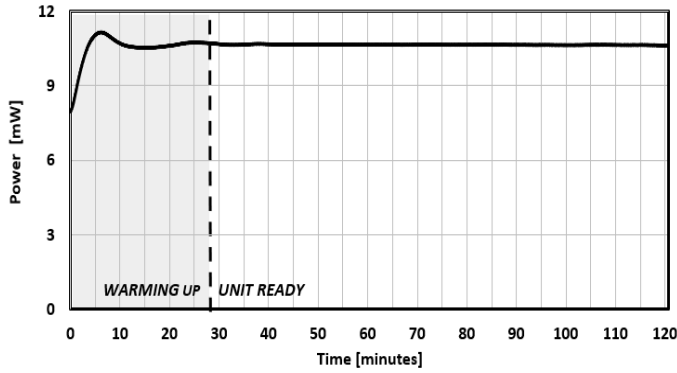
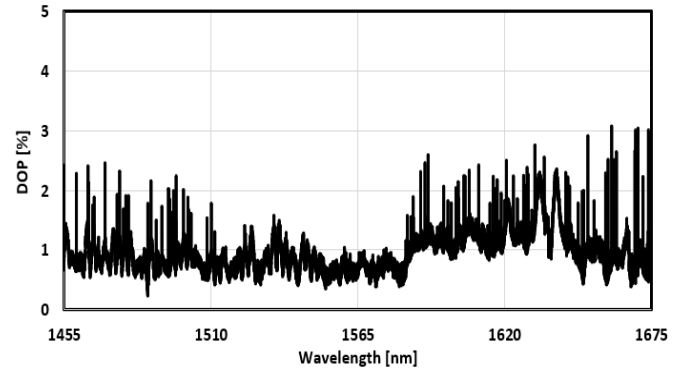

FIG. 8: DEGREE OF POLARIZATION



G. CONNECTORS



Item	Description
A	FC/APC Connector (Optional: FC/PC, SMA)
B	Power Barrel Connector Jack 2.00mm ID, 5.50mm OD, 9.5 mm Length. Center Positive $\ominus \text{---} \oplus$
C	USB 2.0 Type B
D	RJ45 for MODBUS TCP/IP Communication
E	D-SUB 9 Positions for RS-232 Communication
F	Switches to change between PC Mode - Manual Mode and to turn SLED on when operating in Manual Mode

H. D-SUB CONNECTOR PIN OUT

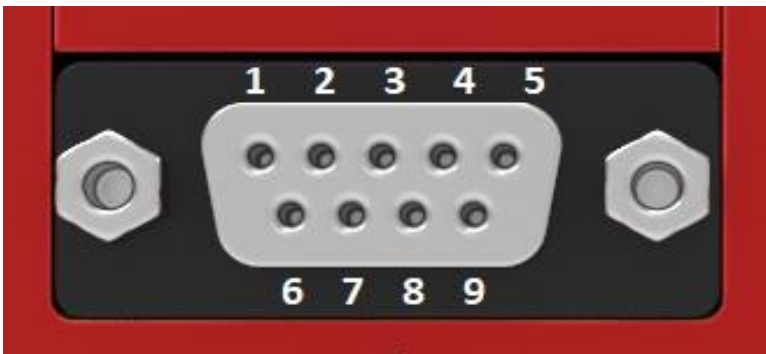

Pin #	Function RS-232
1	Not used
2	Tx
3	Rx
4	Not used
5	GND
6	Not used
7	Not used
8	Not used
9	Not used

I. MANUAL CONTROL

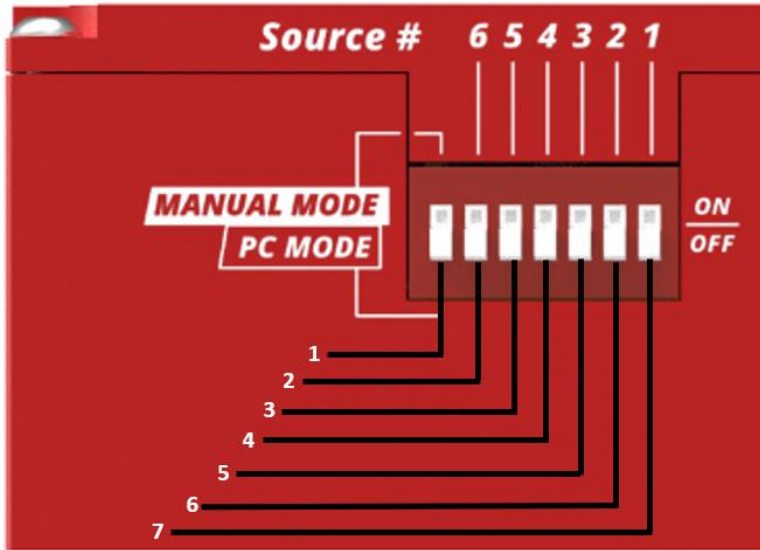

Pin #	UP	DOWN
1	Light Source in Manual Mode	Light Source in PC Mode
2	N/A	N/A
3	N/A	N/A
4	N/A	N/A
5	N/A	N/A
6	SLED 2 ON	SLED 2 OFF
7	SLED 1 ON	SLED 1 OFF

J. OSE2 32-PIN BUTTERFLY PACKAGE PIN OUT

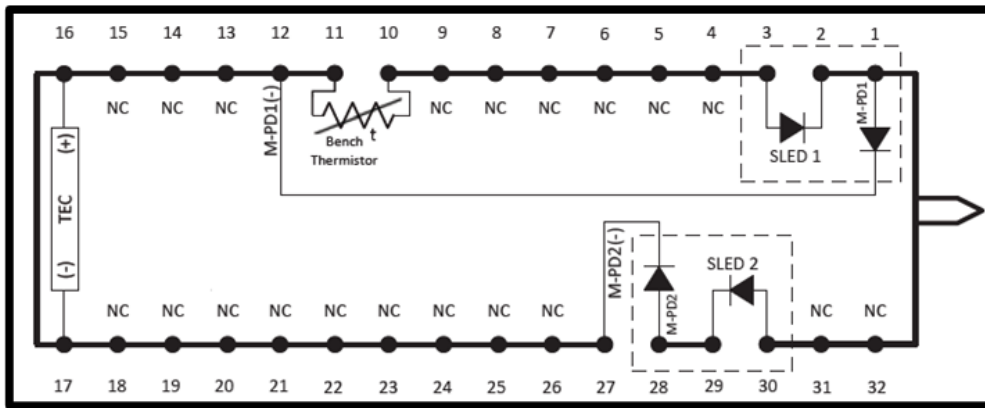

External Pin Assignment – BeST-SLED: 2 SLEDs							
1	M-PD1 (+)	9	NC	17	TEC (-)	25	NC
2	SLED 1 (-)	10	Thermistor	18	NC	26	NC
3	SLED 1 (+)	11	Thermistor	19	NC	27	M-PD2 (-)
4	NC	12	M-PD1 (-)	20	NC	28	M-PD2 (+)
5	NC	13	NC	21	NC	29	SLED 2 (-)
6	NC	14	NC	22	NC	30	SLED 2 (+)
7	NC	15	NC	23	NC	31	NC
8	NC	16	TEC (+)	24	NC	32	NC

K. MECHANICAL DIAGRAM – LOW DOP ISB2

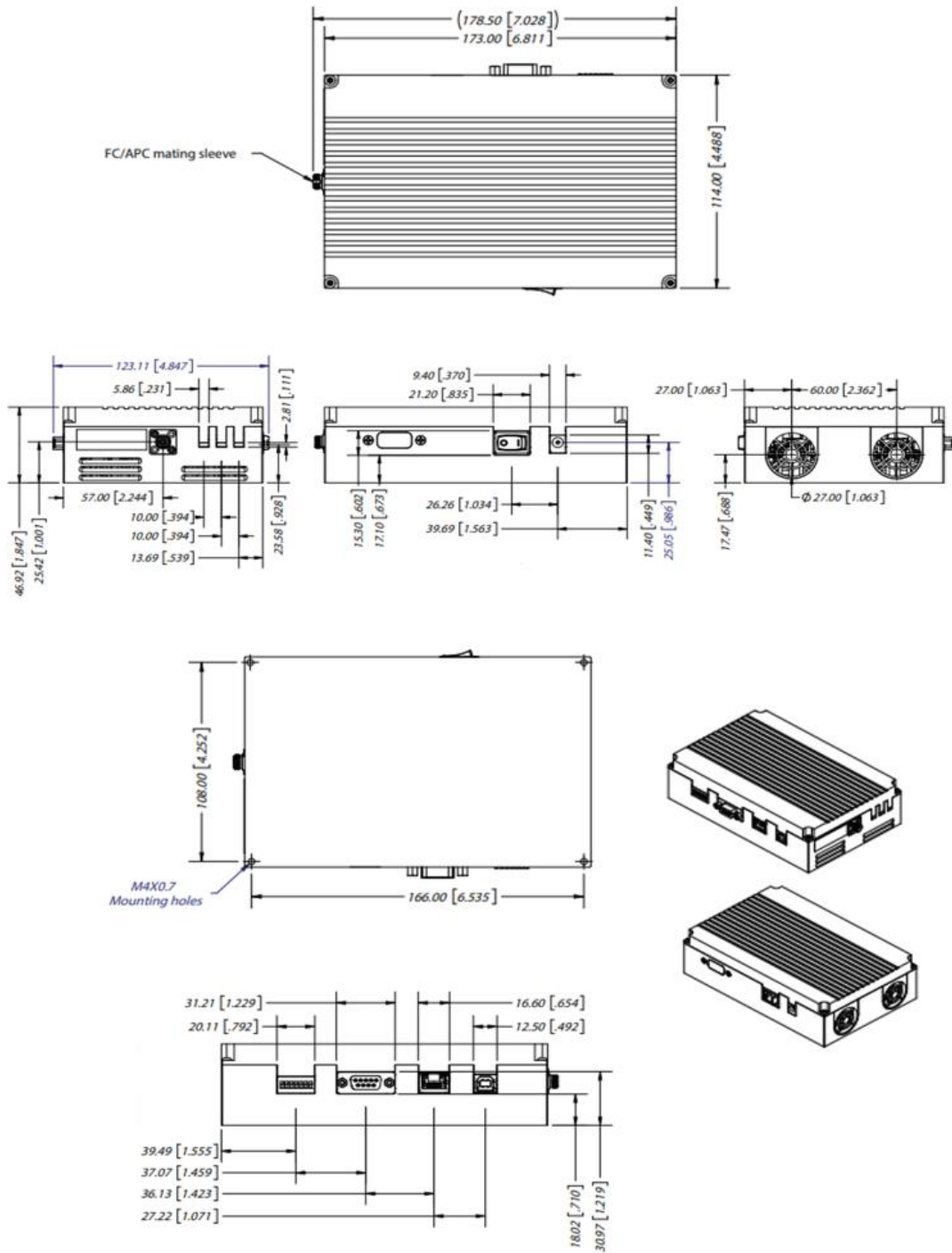

#LTC-ISB2-1550_1615-SM-LP-1530_1630-100-1580-10_DS_2021_08_05

This document is the property of Luxmux, and contains proprietary information. Luxmux reserves the right to make product design or specification changes without notice.

L. MECHANICAL DIAGRAM – LOW DOP ISB2 WITH POWER METER

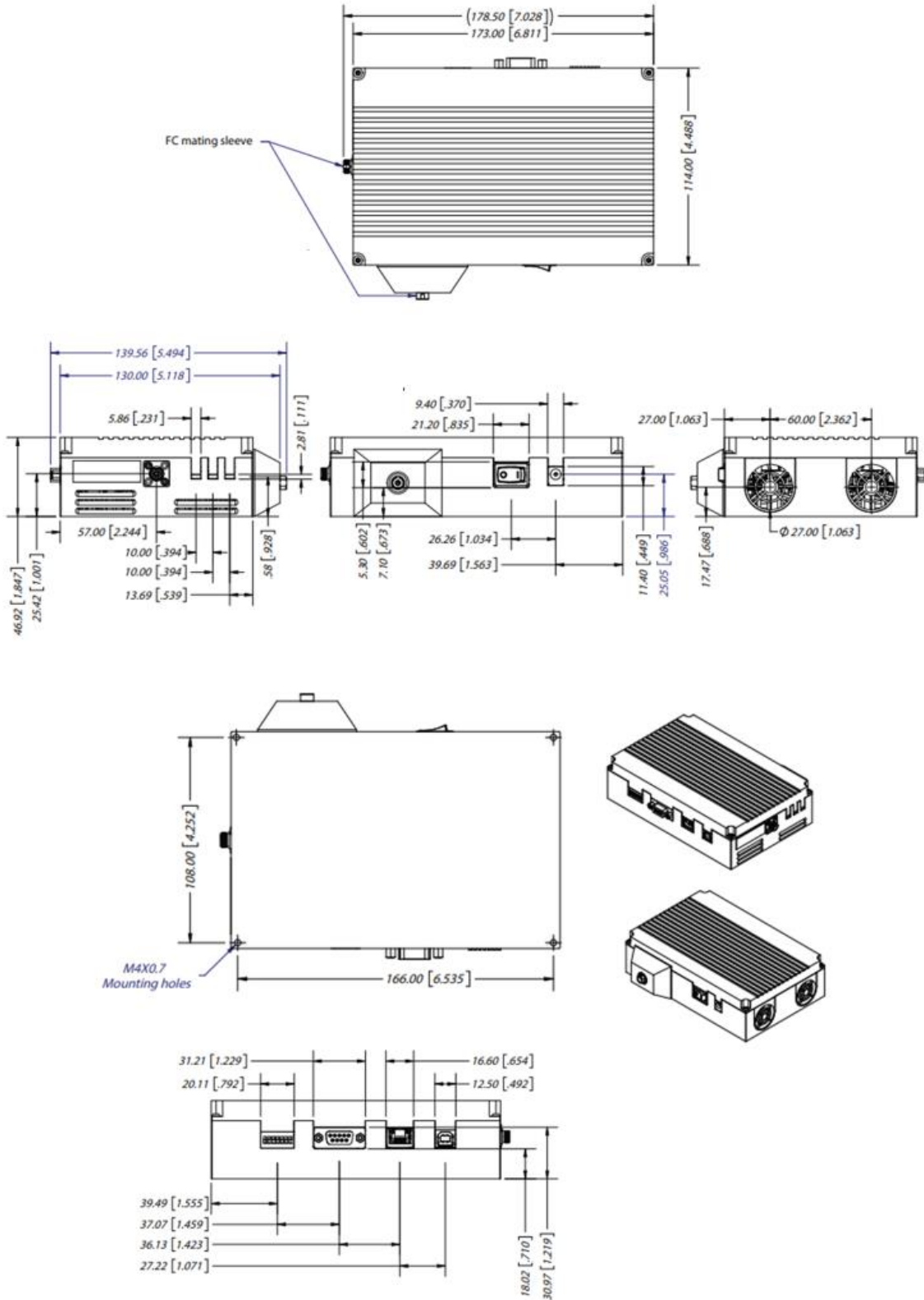

#LTC-ISB2-1550_1615-SM-LP-1530_1630-100-1580-10_DS_2021_08_05

This document is the property of Luxmux, and contains proprietary information. Luxmux reserves the right to make product design or specification changes without notice.

M. SAFETY

All statements regarding safety of operation and technical data will only apply when the unit is operated correctly.

The driver must not be operated in environments susceptible to explosion hazards. Do not obstruct the air ventilation slots. If any parts of the driver, or electronics are broken or exposed, contact Luxmux technical support and do not attempt to operate the unit.

The BeST-SLED® Integrated Spectral Bench (ISB2) is a Class 1M laser product. It is safe for all conditions of use except when passed through magnifying optics such as microscopes and telescopes. It produces a beam that is divergent. If light is re-focused use protective eye wear.

N. APPLICATION PROTOCOL INTERFACE (API)

Luxmux's driver utilizes the MODBUS Protocol for communications. Users can find numerous detailed specifications for the protocol on the internet. MODBUS is used widely in industrial applications. The driver is designed to use this protocol over all of its communication interfaces, MODBUS – RTU is a master/slave protocol and is employed by the USB or RS232 port, and MODBUS - TCP/IP is a client/server protocol and is employed by the Ethernet Interface.

The MODBUS specification has outlined how a user can adapt the overall packet structure to suit each interface requirement. The primary section of a MODBUS packet is known as the Protocol Data Unit (PDU) and it is independent of the underlying communication interface. The PDU includes additional byte fields for the MODBUS transaction per the Application Data Unit (ADU).

A high-level overview of MODBUS Protocol can be found on the BeST-SLED® Integrated Spectral Bench User Manual. If users want to develop their own API, the ISB2 Register Map is available upon request. Please contact technical support: techsupport@luxmux.com.



O. ORDERING CODE

ORDERING CODE:		LTC	ISB2	SLEDs	FT	DOP	SC	FWHM	CW	LOP
LTC	Luxmux Technology Corporation									
ISB2	Best-SLED® Optical Spectral Engine G2									
SLEDs	SLED center wavelength, choose from one of the models in the table 1300nm, 1340nm, 1390nm, 1430nm, 1480nm, 1550nm, 1615nm, 1680nm [choose up to 6]									
FT	Fiber Type, choose 1: PM: Polarization Maintaining SM: Single Mode FS: Free Space									
DOP	Degree of Polarization LP: Low Degree of Polarization HP: High Degree of Polarization									
SC	Spectral Coverage [nm]									
FWHM	Full Width Half Maximum [nm] [FWHM defined as the bandwidth from the lowest spectral dip]									
CW	Center Wavelength [nm]									
LOP	Light Output Power [mW]									

Product Code
 Available Options
 Taken From Table

Part Number	Ordering Code: LTC-ISB2-(SLEDs)-(FT)-(DOP)-(SC)-(FWHM)-(CW)-(LOP)	SLEDs [nm]	FT	SC [nm]	FWHM [nm]	CW [nm]	LOP [mW]
ASM000501	LTC-ISB2-1615_1680-PM-HP-1575_1725-150-1650-12	1615, 1680	PM	1575 - 1725	150	1650	12
ASM000502	LTC-ISB2-1480_1550_1615-PM-HP-1435_1640-205-1538-18	1480, 1550, 1615	PM	1435 - 1640	205	1538	18
ASM000503	LTC-ISB2-1340_1390_1430-PM-HP-1310_1465-155-1388-20	1340, 1390, 1430	PM	1310 - 1465	155	1388	20
ASM000504	LTC-ISB2-1300_1340_1390_1430-PM-HP-1265_1465-200-1365-25	1300, 1340, 1390, 1430	PM	1265 - 1465	200	1365	25
ASM000505	LTC-ISB2-1480_1550_1615_1680-PM-HP-1435_1725-290-1580-25	1480, 1550, 1615, 1680	PM	1435 - 1725	290	1580	25
ASM000506	LTC-ISB2-1300_1340_1390_1430_1480-PM-HP-1265_1500-235-1383-35	1300, 1340, 1390, 1430, 1480	PM	1265 - 1500	235	1383	35
ASM000507	LTC-ISB2-1340_1390_1430_1480_1550-PM-HP-1305_1605-300-1455-35	1340, 1390, 1430, 1480, 1550	PM	1305 - 1605	300	1455	35
ASM000508	LTC-ISB2-1300_1390_1480_1550_1615_1680-PM-HP-1265_1725-460-1495-40	1300, 1390, 1480, 1550, 1615, 1680	PM	1265 - 1725	460	1495	40
ASM000509	LTC-ISB2-1480_1550-PM-HP-1435_1605-170-1520-12	1480, 1550	PM	1435 - 1605	170	1520	12
ASM000510	LTC-ISB2-1340_1390_1430_1480_1550_1615-PM-HP-1310_1640-330-1475-38	1340, 1390, 1430, 1480, 1550, 1615	PM	1310 - 1640	330	1475	38
ASM000511	LTC-ISB2-1300_1340_1390_1430_1480_1550-PM-HP-1265_1605-340-1435-40	1300, 1340, 1390, 1430, 1480, 1550	PM	1265 - 1605	340	1435	40
ASM000512	LTC-ISB2-1430_1480_1550-PM-HP-1410_1605-195-1508-19	1430, 1480, 1550	PM	1410 - 1605	195	1508	19
ASM000513	LTC-ISB2-1300_1340_1390-PM-HP-1265_1420-155-1343-20	1300, 1340, 1390	PM	1265 - 1420	155	1343	20
ASM000514	LTC-ISB2-1390_1430_1480-PM-HP-1355_1500-145-1428-19	1390, 1430, 1480	PM	1355 - 1500	145	1428	19
ASM000515	LTC-ISB2-1550_1615_1680-PM-HP-1515_1725-210-1620-18	1550, 1615, 1680	PM	1515 - 1725	210	1620	18
ASM000516	LTC-ISB2-1300_1340-PM-HP-1265_1365-100-1315-12	1300, 1340	PM	1265 - 1365	100	1315	12
ASM000517	LTC-ISB2-1390_1480_1550-PM-HP-1340_1610-270-1475-20	1390, 1480, 1550	PM	1340 - 1610	270	1475	20
ASM000518	LTC-ISB2-1300_1390_1480-PM-HP-1265_1500-235-1383-20	1300, 1390, 1480	PM	1265 - 1500	235	1383	20
ASM000519	LTC-ISB2-1390_1480_1550_1615_1680-PM-HP-1340_1725-385-1533-32	1390, 1480, 1550, 1615, 1680	PM	1340 - 1725	385	1533	32
ASM000520	LTC-ISB2-1550_1615-PM-HP-1530_1630-100-1580-10	1550, 1615	PM	1530 - 1630	100	1580	10

#LTC-ISB2-1550_1615-SM-LP-1530_1630-100-1580-10_DS_2021_08_05

This document is the property of Luxmux, and contains proprietary information. Luxmux reserves the right to make product design or specification changes without notice.



Redefining Spectral Boundaries

Part Number	Ordering Code: LTC-ISB2-(SLEDS)-(FT)-(DOP)-(SC)-(FWHM)-(CW)-(LOP)	SLEDS [nm]	FT	SC [nm]	FWHM [nm]	CW [nm]	LOP [mW]
ASM000601	LTC-ISB2-1615_1680-SM-HP-1575_1725-150-1650-12	1615, 1680	SM	1575 - 1725	150	1650	12
ASM000602	LTC-ISB2-1480_1550_1615-SM-HP-1435_1640-205-1538-18	1480, 1550, 1615	SM	1435 - 1640	205	1538	18
ASM000603	LTC-ISB2-1340_1390_1430-SM-HP-1310_1465-155-1388-20	1340, 1390, 1430	SM	1310 - 1465	155	1388	20
ASM000604	LTC-ISB2-1300_1340_1390_1430-SM-HP-1265_1465-200-1365-25	1300, 1340, 1390, 1430	SM	1265 - 1465	200	1365	25
ASM000605	LTC-ISB2-1480_1550_1615_1680-SM-HP-1435_1725-290-1580-25	1480, 1550, 1615, 1680	SM	1435 - 1725	290	1580	25
ASM000606	LTC-ISB2-1300_1340_1390_1430_1480-SM-HP-1265_1500-235-1383-35	1300, 1340, 1390, 1430, 1480	SM	1265 - 1500	235	1383	35
ASM000607	LTC-ISB2-1340_1390_1430_1480_1550-SM-HP-1305_1605-300-1455-35	1340, 1390, 1430, 1480, 1550	SM	1305 - 1605	300	1455	35
ASM000608	LTC-ISB2-1300_1390_1480_1550_1615_1680-SM-HP-1265_1725-460-1495-40	1300, 1390, 1480, 1550, 1615, 1680	SM	1265 - 1725	460	1495	40
ASM000609	LTC-ISB2-1480_1550-SM-HP-1435_1605-170-1520-12	1480, 1550	SM	1435 - 1605	170	1520	12
ASM000610	LTC-ISB2-1340_1390_1430_1480_1550_1615-SM-HP-1310_1640-330-1475-38	1340, 1390, 1430, 1480, 1550, 1615	SM	1310 - 1640	330	1475	38
ASM000611	LTC-ISB2-1300_1340_1390_1430_1480_1550-SM-HP-1265_1605-340-1435-40	1300, 1340, 1390, 1430, 1480, 1550	SM	1265 - 1605	340	1435	40
ASM000612	LTC-ISB2-1430_1480_1550-SM-HP-1410_1605-195-1508-19	1430, 1480, 1550	SM	1410 - 1605	195	1508	19
ASM000613	LTC-ISB2-1300_1340_1390-SM-HP-1265_1420-155-1343-20	1300, 1340, 1390	SM	1265 - 1420	155	1343	20
ASM000614	LTC-ISB2-1390_1430_1480-SM-HP-1355_1500-145-1428-19	1390, 1430, 1480	SM	1355 - 1500	145	1428	19
ASM000615	LTC-ISB2-1550_1615_1680-SM-HP-1515_1725-210-1620-18	1550, 1615, 1680	SM	1515 - 1725	210	1620	18
ASM000616	LTC-ISB2-1300_1340-SM-HP-1265_1365-100-1315-12	1300, 1340	SM	1265 - 1365	100	1315	12
ASM000617	LTC-ISB2-1390_1480_1550-SM-HP-1340_1610-270-1475-20	1390, 1480, 1550	SM	1340 - 1610	270	1475	20
ASM000618	LTC-ISB2-1300_1390_1480-SM-HP-1265_1500-235-1383-20	1300, 1390, 1480	SM	1265 - 1500	235	1383	20
ASM000619	LTC-ISB2-1390_1480_1550_1615_1680-SM-HP-1340_1725-385-1533-32	1390, 1480, 1550, 1615, 1680	SM	1340 - 1725	385	1533	32
ASM000620	LTC-ISB2-1550_1615-SM-HP-1530_1630-100-1580-10	1550, 1615	SM	1530 - 1630	100	1580	10

Part Number	Ordering Code: LTC-ISB2-(SLEDS)-(FT)-(DOP)-(SC)-(FWHM)-(CW)-(LOP)	SLEDS [nm]	FT	SC [nm]	FWHM [nm]	CW [nm]	LOP [mW]
ASM000701	LTC-ISB2-1615_1680-SM-LP-1575_1725-150-1650-12	1615, 1680	SM	1575 - 1725	150	1650	12
ASM000702	LTC-ISB2-1480_1550_1615-SM-LP-1435_1640-205-1538-18	1480, 1550, 1615	SM	1435 - 1640	205	1538	18
ASM000703	LTC-ISB2-1340_1390_1430-SM-LP-1310_1465-155-1388-20	1340, 1390, 1430	SM	1310 - 1465	155	1388	20
ASM000704	LTC-ISB2-1300_1340_1390_1430-SM-LP-1265_1465-200-1365-25	1300, 1340, 1390, 1430	SM	1265 - 1465	200	1365	25
ASM000705	LTC-ISB2-1480_1550_1615_1680-SM-LP-1435_1725-290-1580-25	1480, 1550, 1615, 1680	SM	1435 - 1725	290	1580	25
ASM000706	LTC-ISB2-1300_1340_1390_1430_1480-SM-LP-1265_1500-235-1383-35	1300, 1340, 1390, 1430, 1480	SM	1265 - 1500	235	1383	35
ASM000707	LTC-ISB2-1340_1390_1430_1480_1550-SM-LP-1305_1605-300-1455-35	1340, 1390, 1430, 1480, 1550	SM	1305 - 1605	300	1455	35
ASM000708	LTC-ISB2-1300_1390_1480_1550_1615_1680-SM-LP-1265_1725-460-1495-40	1300, 1390, 1480, 1550, 1615, 1680	SM	1265 - 1725	460	1495	40
ASM000709	LTC-ISB2-1480_1550-SM-LP-1435_1605-170-1520-12	1480, 1550	SM	1435 - 1605	170	1520	12
ASM000710	LTC-ISB2-1340_1390_1430_1480_1550_1615-SM-LP-1310_1640-330-1475-38	1340, 1390, 1430, 1480, 1550, 1615	SM	1310 - 1640	330	1475	38
ASM000711	LTC-ISB2-1300_1340_1390_1430_1480_1550-SM-LP-1265_1605-340-1435-40	1300, 1340, 1390, 1430, 1480, 1550	SM	1265 - 1605	340	1435	40
ASM000712	LTC-ISB2-1430_1480_1550-SM-LP-1410_1605-195-1508-19	1430, 1480, 1550	SM	1410 - 1605	195	1508	19
ASM000713	LTC-ISB2-1300_1340_1390-SM-LP-1265_1420-155-1343-20	1300, 1340, 1390	SM	1265 - 1420	155	1343	20
ASM000714	LTC-ISB2-1390_1430_1480-SM-LP-1355_1500-145-1428-19	1390, 1430, 1480	SM	1355 - 1500	145	1428	19
ASM000715	LTC-ISB2-1550_1615_1680-SM-LP-1515_1725-210-1620-18	1550, 1615, 1680	SM	1515 - 1725	210	1620	18
ASM000716	LTC-ISB2-1300_1340-SM-LP-1265_1365-100-1315-12	1300, 1340	SM	1265 - 1365	100	1315	12
ASM000717	LTC-ISB2-1390_1480_1550-SM-LP-1340_1610-270-1475-20	1390, 1480, 1550	SM	1340 - 1610	270	1475	20
ASM000718	LTC-ISB2-1300_1390_1480-SM-LP-1265_1500-235-1383-20	1300, 1390, 1480	SM	1265 - 1500	235	1383	20
ASM000719	LTC-ISB2-1390_1480_1550_1615_1680-SM-LP-1340_1725-385-1533-32	1390, 1480, 1550, 1615, 1680	SM	1340 - 1725	385	1533	32
ASM000720	LTC-ISB2-1550_1615-SM-LP-1530_1630-100-1580-10	1550, 1615	SM	1530 - 1630	100	1580	10

#LTC-ISB2-1550_1615-SM-LP-1530_1630-100-1580-10_DS_2021_08_05

This document is the property of Luxmux, and contains proprietary information. Luxmux reserves the right to make product design or specification changes without notice.



Redefining Spectral Boundaries

Part Number	Ordering Code: LTC-ISB2-(SLEDS)-(FT)-(DOP)-(SC)-(FWHM)-(CW)-(LOP)	SLEDS [nm]	FT	SC [nm]	FWHM [nm]	CW [nm]	LOP [mW]
ASM000801	LTC-ISB2-1615_1680-FS-HP-1575_1725-150-1650-35	1615, 1680	FS	1575 - 1725	150	1650	35
ASM000802	LTC-ISB2-1480_1550_1615-FS-HP-1435_1640-205-1538-55	1480, 1550, 1615	FS	1435 - 1640	205	1538	55
ASM000803	LTC-ISB2-1340_1390_1430-FS-HP-1310_1465-155-1388-65	1340, 1390, 1430	FS	1310 - 1465	155	1388	65
ASM000804	LTC-ISB2-1300_1340_1390_1430-FS-HP-1265_1465-200-1365-90	1300, 1340, 1390, 1430	FS	1265 - 1465	200	1365	90
ASM000805	LTC-ISB2-1480_1550_1615_1680-FS-HP-1435_1725-290-1580-80	1480, 1550, 1615, 1680	FS	1435 - 1725	290	1580	80
ASM000806	LTC-ISB2-1300_1340_1390_1430_1480-FS-HP-1265_1500-235-1383-115	1300, 1340, 1390, 1430, 1480	FS	1265 - 1500	235	1383	115
ASM000807	LTC-ISB2-1340_1390_1430_1480_1550-FS-HP-1305_1605-300-1455-110	1340, 1390, 1430, 1480, 1550	FS	1305 - 1605	300	1455	110
ASM000808	LTC-ISB2-1300_1390_1480_1550_1615_1680-FS-HP-1265_1725-460-1495-125	1300, 1390, 1480, 1550, 1615, 1680	FS	1265 - 1725	460	1495	125
ASM000809	LTC-ISB2-1480_1550-FS-HP-1435_1605-170-1520-45	1480, 1550	FS	1435 - 1605	170	1520	45
ASM000810	LTC-ISB2-1340_1390_1430_1480_1550_1615-FS-HP-1310_1640-330-1475-120	1340, 1390, 1430, 1480, 1550, 1615	FS	1310 - 1640	330	1475	120
ASM000811	LTC-ISB2-1300_1340_1390_1430_1480_1550-FS-HP-1265_1605-340-1435-130	1300, 1340, 1390, 1430, 1480, 1550	FS	1265 - 1605	340	1435	130
ASM000812	LTC-ISB2-1430_1480_1550-FS-HP-1410_1605-195-1508-60	1430, 1480, 1550	FS	1410 - 1605	195	1508	60
ASM000813	LTC-ISB2-1300_1340_1390-FS-HP-1265_1420-155-1343-70	1300, 1340, 1390	FS	1265 - 1420	155	1343	70
ASM000814	LTC-ISB2-1390_1430_1480-FS-HP-1355_1500-145-1428-65	1390, 1430, 1480	FS	1355 - 1500	145	1428	65
ASM000815	LTC-ISB2-1550_1615_1680-FS-HP-1515_1725-210-1620-55	1550, 1615, 1680	FS	1515 - 1725	210	1620	55
ASM000816	LTC-ISB2-1300_1340-FS-HP-1265_1365-100-1315-50	1300, 1340	FS	1265 - 1365	100	1315	50
ASM000817	LTC-ISB2-1390_1480_1550-FS-HP-1340_1610-270-1475-60	1390, 1480, 1550	FS	1340 - 1610	270	1475	60
ASM000818	LTC-ISB2-1300_1390_1480-FS-HP-1265_1500-235-1383-70	1300, 1390, 1480	FS	1265 - 1500	235	1383	70
ASM000819	LTC-ISB2-1390_1480_1550_1615_1680-FS-HP-1340_1725-385-1533-100	1390, 1480, 1550, 1615, 1680	FS	1340 - 1725	385	1533	100
ASM000820	LTC-ISB2-1550_1615-FS-HP-1530_1630-100-1580-30	1550, 1615	FS	1530 - 1630	100	1580	30

#LTC-ISB2-1550_1615-SM-LP-1530_1630-100-1580-10_DS_2021_08_05

This document is the property of Luxmux, and contains proprietary information. Luxmux reserves the right to make product design or specification changes without notice.