

MALE PLUG RJ45 STRAIGHT TO PLUG RJ45 PUSH-PULL STRAIGHT

OVERMOLD VIEW FOR CABLES O.D. ≤ 6.7mm

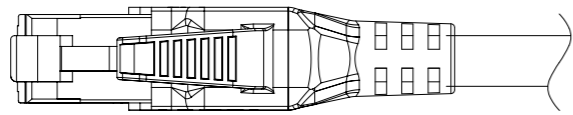

OVERMOLD VIEW FOR CABLES O.D. ≥ 6.7mm

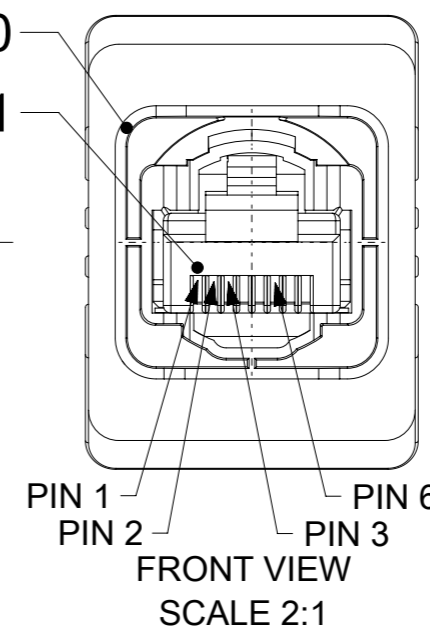
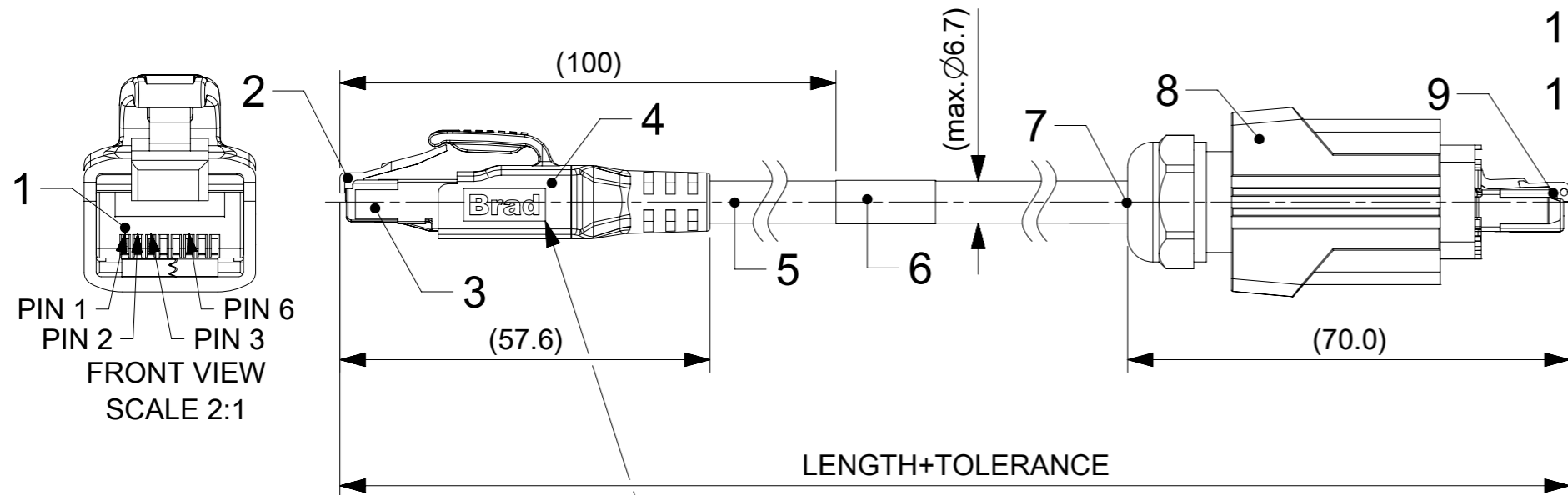
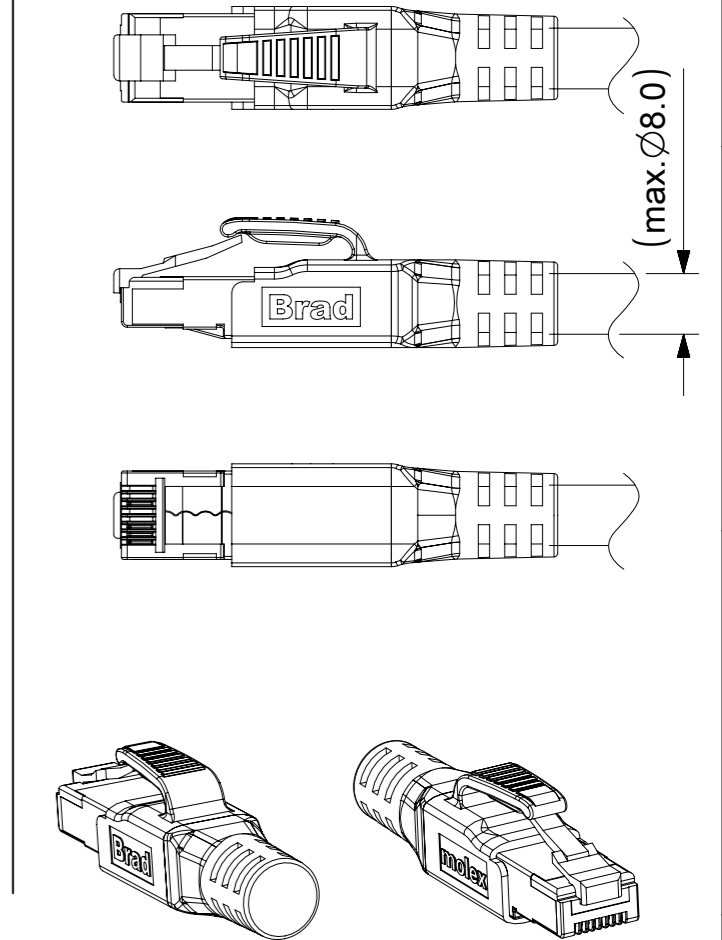

BLACK OVERMOULD
MOLEX LOGO ON ONE SIDE
BRAD LOGO ON OTHER SIDE

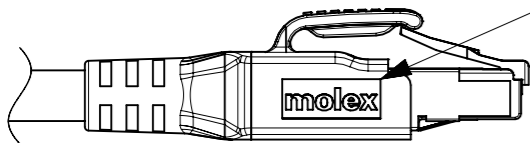

WIRING DIAGRAM



NOTES:

- MATERIAL : SEE BOM TABLE
- FINISHES : SEE BOM TABLE
- ELECTRICAL DATA:
MAX. VOLTAGE RATING 30 V
MAX. CURRENT PER CONTACT 1.5 A
- ENVIRONMENTAL:
STATIC OPERATING TEMP. : -25°C to +85°C
INDEX OF PROTECTION : IP20
- FOR MORE INFORMATION SEE PRODUCT SPECIFICATION 1201080202 PS P00

BOM

ITEM	QTY.	DESCRIPTION	MATERIAL	FINISH
11	8	CONTACTS	COPPER ALLOY	GOLD OVER NICKEL
10	1	SEAL	NBR	---
9	1	CONTACT CARRIER	PC	---
8	1	HOUSING	ZINC DIE-CAST	NICKEL
7	1	SEAL CABLE	TPE	---
6	1	LABEL	VINYL	---
5	-	CABLE	SEE SHEET 2	---
4	-	OVERMOULDING BLACK	TPU	---
3	1	SHIELD	BRASS	TIN
2	1	PLUG RJ45 TRANSPARENT	POLYCARBONATE	---
1	4 or 8	CONTACT RJ45 MALE	PHOSPHOR BRONZE	SELECTIVE GOLD

FUNCTIONAL SYMBOLS		THIS DRAWING CONTAINS INFORMATION THAT IS PROPRIETARY TO MOLEX ELECTRONIC TECHNOLOGIES, LLC AND SHOULD NOT BE USED WITHOUT WRITTEN PERMISSION		CURRENT REV DESC:			
▽/A = 0	mm	SCALE	1:1	EC NO: 672185			
▽/E = 0	GENERAL TOLERANCES (UNLESS SPECIFIED)		4 PLACES ±		DRWN: JMARSZALEK	2016/10/11	
▽/V = 0	ANGULAR TOL ± 1.0°		3 PLACES ±		CHK'D: RSILLER	2021/09/20	
DIVISIONAL SYMBOLS		2 PLACES ± 0.05		APPR: RSILLER		2021/09/20	
		1 PLACE ± 0.3		INITIAL REVISION:		DOCUMENT NUMBER	
		0 PLACES ± 0.5		DRWN: JMARSZALEK		1201080205	
DRAFT WHERE APPLICABLE MUST REMAIN WITHIN DIMENSIONS		THIRD ANGLE PROJECTION		SERIES		DOC TYPE DOC PART REVISION	
		DRAWING		120108		PSD 000 A	
		A3-SIZE		MATERIAL NUMBER		CUSTOMER	
		SEE PART LIST		GENERAL MARKET		SHEET NUMBER	
						1 OF 2	

NUMERICAL CODE (Available parts see PART LIST table. Other parts available upon request).

OPTIONS

E 6 7 A 0 6 0 X X M X X X X

- E=Ethernet
- Heads:
6=RJ45
7=RJ45
PUSH-PULL
- Wiring type
- Heads style:
060=MA M12 STR
/ RJ45 Plug STR
- Cable type:
See cable table
- Units:
M=Meter
- Length
Examples:
005=0.5 units
010=1 units
150=15 units
- H= 2 pcs. of
I/D Carrier

CABLE INFORMATION (for more information see Cable Data Sheet).

CABLE TYPE	CABLE O.D.	APPLICATION	CROSS SECTION	CABLE JACKET	UL	TEMP. RANGE STATIC BENDING RADIUS STATIC	TEMP. RANGE DYNAMIC BENDING RADIUS DYNAMIC	CYCLES	ADDITIONAL INFORMATION
11	6.8mm	PROFINET TYPE C	22AWG	PUR GREEN	STYLE 20549	-40°C to +80°C / min.5xO.D.	-20°C to +70°C / min.7.5xO.D.	up to 5 Mio	-
12	6.7mm	PROFINET TYPE B	22AWG	TPU BASED GREEN	STYLE 21215	-40°C to +80°C / min.5xO.D.	-25°C to +80°C / min.15xO.D.	about 2M, min.15xO.D., -5°C to +60°C	WSOR
16	6.5mm	-	24AWG	TPU BASED TEAL	STYLE 21215	-40°C to +80°C / min.6xO.D.	-20°C to +50°C	1M, min.10xO.D. / 2M min.20xO.D. @20°C	WSOR

PART LIST

No.	MOLEX P/N	ENGINEERING NO.	CABLE LENGTH
1	1201080205	E67A06011M020	2m
2	1201080218	E67A06011M030	3m
3	1201080219	E67A06011M040	4m
4	1201080220	E67A06011M050	5m
5	1201080225	E67A06011M150	15m
6	1201080226	E67A06011M340	34m
7	1201080227	E67A06011M350	35m
8	1201080228	E67A06011M160	16m
9	1201080229	E67A06011M170	17m
10	1201080230	E67A06011M180	18m
11	1201080231	E67A06011M200	20m
12	1201080232	E67A06011M250	25m
13	1201080233	E67A06011M300	30m
14	1201080234	E67A06011M400	40m
15	1201080235	E67A06011M450	45m
16			
17			
18			
19			
20			
21			
22			
23			
24			
25			

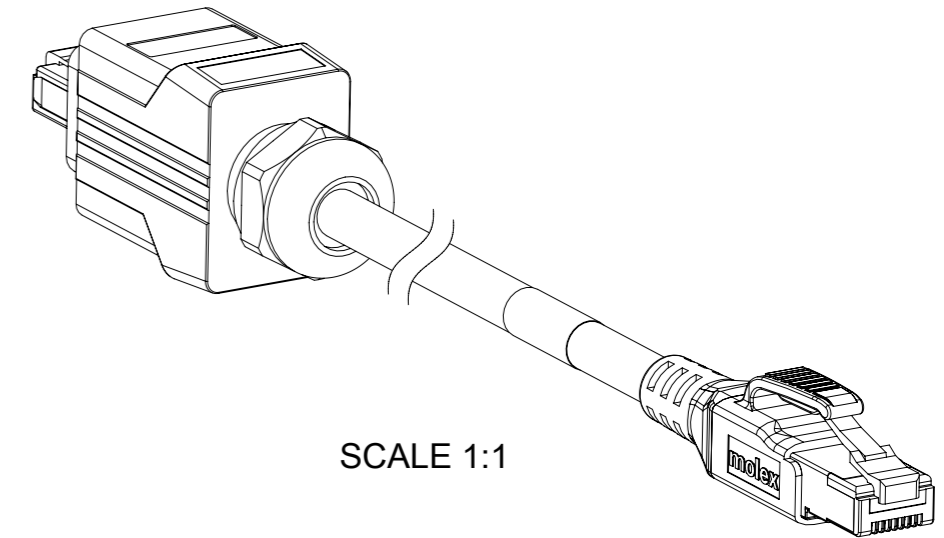

CABLE LENGTH TOLERANCES

LENGTH	TOLERANCE
0 m-1 m	+40 mm
>1 m-5 m	+60 mm
>5 m-10 m	+80 mm
>10 m-20 m	+140 mm
>20 m-30 m	+160 mm
>30 m	+1% length

FUNCTIONAL SYMBOLS	THIS DRAWING CONTAINS INFORMATION THAT IS PROPRIETARY TO MOLEX ELECTRONIC TECHNOLOGIES, LLC AND SHOULD NOT BE USED WITHOUT WRITTEN PERMISSION		CURRENT REV DESC:	
$\nabla_A = 0$	DIMENSION UNITS: mm	SCALE: 1:1	 CSE RJ45 PUSH-PULL RJ45 8P4C MA STR MA PRODUCT CUSTOMER DRAWING	
$\nabla_E = 0$	GENERAL TOLERANCES (UNLESS SPECIFIED)			
$\nabla_V = 0$	ANGULAR TOL $\pm 1.0^\circ$			
DIVISIONAL SYMBOLS	4 PLACES \pm			
	3 PLACES \pm	EC NO: 672185	2016/10/11	
	2 PLACES ± 0.05	DRWN: JMARSZALEK	2021/09/20	
	1 PLACE ± 0.3	CHK'D: RSILLER	2021/09/20	
	0 PLACES ± 0.5	APPR: RSILLER		
	DRAFT WHERE APPLICABLE MUST REMAIN WITHIN DIMENSIONS	INITIAL REVISION:	2016/03/08	
	THIRD ANGLE PROJECTION	DRWN: JMARSZALEK	2021/09/20	
	DRAWING	APPR: RSILLER		
	SERIES			
	MATERIAL NUMBER	120108	1201080205	
	CUSTOMER	SEE PART LIST	GENERAL MARKET	
	SHEET NUMBER			2 OF 2