

# Low Profile IDC 22-28AWG

9176-800

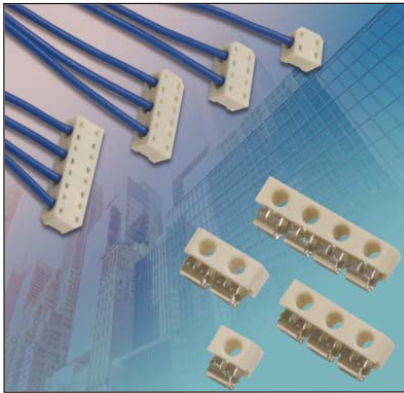

AVX industrial/transportation grade insulation displacement connectors (IDC) have been proven in the market for over ten years. Providing a very simple one-step termination process, these connectors proved a robust wire-to-board (WTB) termination in harsh applications.

The 9176-800 series has been developed specifically for 22-28AWG discrete wires in size critical applications. By reducing the “Z” axis height by 1.0mm and the overall volume by up to 50%, this new package size is an ideal choice in space constrained applications over previous IDC connectors. In addition, an expanded size range is available starting from a 1 position up to 4 positions in each wire gauge. The entire range provides new packaging solutions in industrial, medical and transportation applications such as smart metering, LED lighting, industrial controls and portable monitoring and measurement devices.

## APPLICATIONS

- Connecting discrete wires and components to a PCB
- Bringing power and signals onto a PCB
- Daisy chaining or interconnecting PCB's together
- Application Notes: Refer to 201-01-216

## FEATURES AND BENEFITS

- Redundant and fatigue resistant phosphor bronze material provides a gas tight, cold welded connection to the wire
- IDC connectors can be potted or over molded to encapsulate electronic modules and provide environmental protection
- The 1p version is available in industry standard colors to match individual wires for error free wire termination

## ELECTRICAL

- Current Rating: 22AWG: 6 amps  
24AWG: 5 amps  
26AWG: 4 amps  
28AWG: 3 amps
- Voltage Rating: 1p: 600V  
2p-4p: 100V
- Durability: 1 Cycle

## ENVIRONMENTAL

- Operating Temperature: -40°C to +125°C

## MECHANICAL

- Insulator Material: Glass-Filled Nylon 46; UL94V0
- Contact Material: Phosphor Bronze
- Plating: Lead-Free Tin Over Nickel

## HOW TO ORDER

**00**  
Prefix  
Wire to Board  
Connector

**9176**  
Series

**00X**  
Number  
of Ways  
001 = 1  
002 = 2  
003 = 3  
004 = 4

**8XX**  
Wire Gauge Size

Code	Accepted Wire Gauge Gauge	Maximum Wire Insulation Diameter	UL Approved
853	22AWG Solid and Stranded	1.40	Approved
863	24AWG Solid and Stranded	1.40	Approved
873	26AWG Solid and Stranded	1.40	Approved
884	28AWG Solid and Stranded	0.80	Not Currently Approved

**X**  
Insulator Color  
9 = White Standard  
Solid Colors (1p only)  
2 = Brown  
3 = Blue  
4 = Yellow  
5 = Red  
6 = Green  
7 = Orange  
8 = Black

**06**  
Plating Option  
06 = Pure Tin  
All Over Nickel

Certification: UL File #E90723

### 00-9176-001-8X3-X06

#### 1 WAY

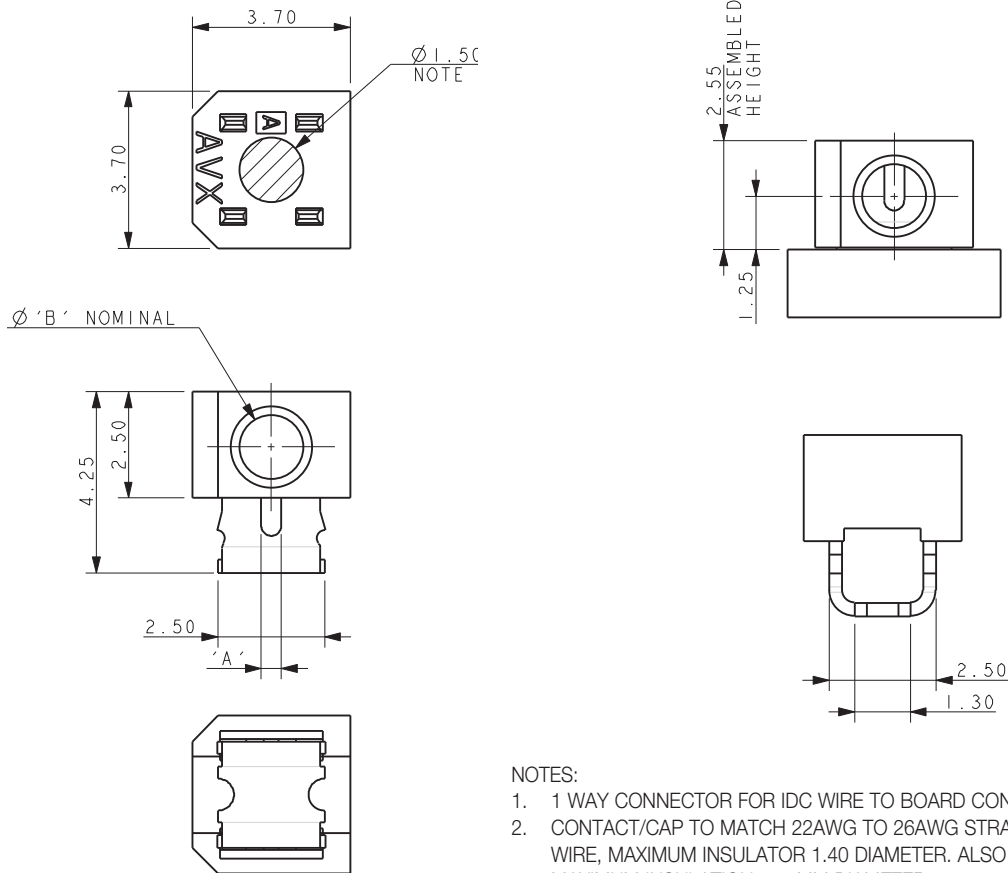

PART NUMBER See page 54	WIRE GAUGE	B	A
00-9176-001-853-X06	22AWG Solid and Stranded	1.50	0.47
00-9176-001-863-X06	24AWG Solid and Stranded	1.50	0.37
00-9176-001-873-X06	26AWG Solid and Stranded	1.50	0.28
00-9176-001-884-X06	28AWG Solid and Stranded	0.90	0.20

### SUGGESTED PCB LAYOUT

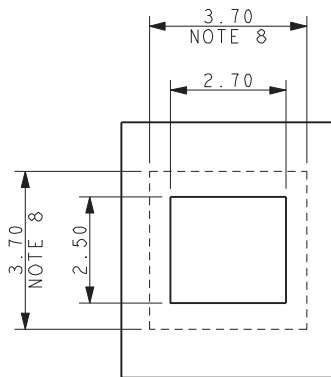

#### NOTES:

- 1 WAY CONNECTOR FOR IDC WIRE TO BOARD CONNECTOR.
- CONTACT/CAP TO MATCH 22AWG TO 26AWG STRANDED AND SOLID WIRE, MAXIMUM INSULATOR 1.40 DIAMETER. ALSO 28AWG WIRES OF MAXIMUM INSULATION 0.80MM DIAMETER.
- FLAT FACE ON TOP OF CAP TO AID PICK AND PLACE ASSEMBLY.
- FOR FULL PRODUCT SPECIFICATION REFER TO AVX SPEC 201-01-215.
- ASSEMBLY PROCEDURE, REFER TO APPLICATION NOTES 201-01-216.
- GENERAL TOLERANCE  $\pm 0.20$  UNLESS STATED.
- PACKED IN TAPE AND REEL, QUANTITY PER REEL 1700.
- CONNECTOR OUTLINE.
- CONTACT MATERIAL: TIN PLATED COPPER ALLOY.
- INSULATOR MATERIAL: HIGH TEMPERATURE NYLON, GLASS FILLED. UL94 V-0, COLOR REFER TO PAGE 54.
- PRODUCT CODES FOR 22AWG TO 26AWG UL REFERENCE E90723 (US AND CANADA). 28AWG HAS NOT YET GAINED APPROVAL.

### PACKING DETAILS

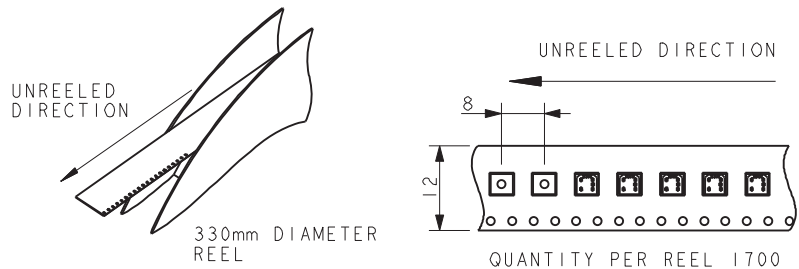

### 00-9176-001-8X3-X06

### 2 WAY

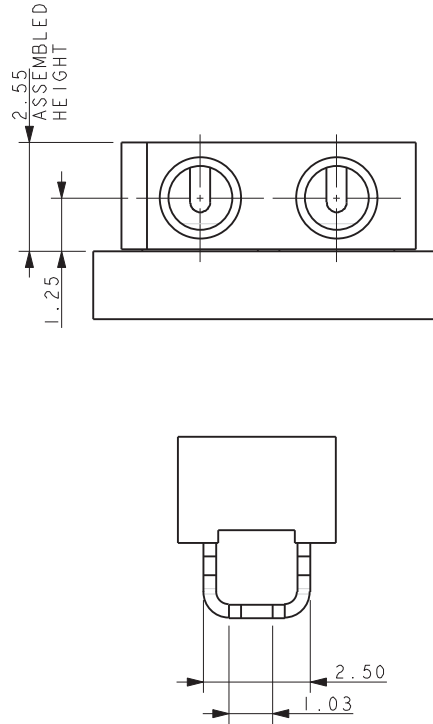
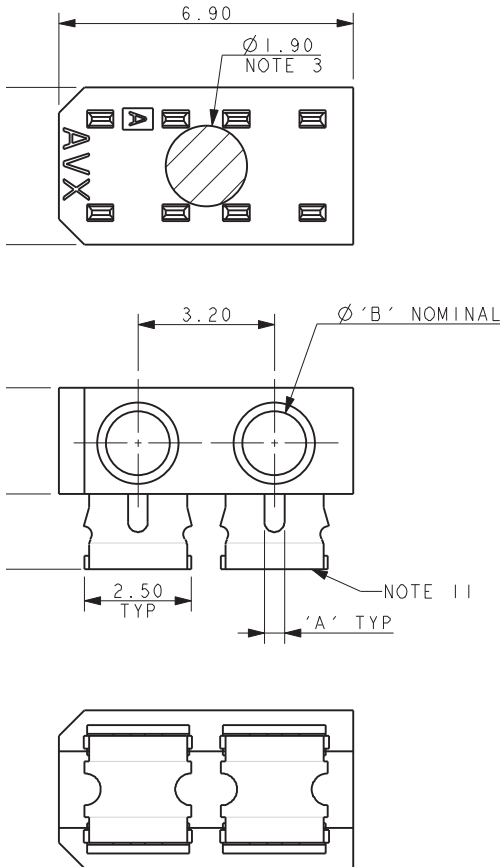

#### NOTES:

- 2 WAY CONNECTOR FOR IDC WIRE TO BOARD CONNECTOR.
- CONTACT/CAP TO MATCH 22AWG TO 26AWG STRANDED AND SOLID WIRE, MAXIMUM INSULATOR 1.40 DIAMETER. ALSO 28AWG WIRES OF MAXIMUM INSULATION 0.80MM DIAMETER.
- FLAT FACE ON TOP OF CAP TO AID PICK AND PLACE ASSEMBLY.
- FOR FULL PRODUCT SPECIFICATION REFER TO AVX SPEC 201-01-215.
- ASSEMBLY PROCEDURE, REFER TO APPLICATION NOTES 201-01-216.
- GENERAL TOLERANCE  $\pm 0.20$  UNLESS STATED.
- PACKED IN TAPE AND REEL, QUANTITY PER REEL 1700.
- CONNECTOR OUTLINE.
- CONTACT MATERIAL: TIN PLATED COPPER ALLOY.
- INSULATOR MATERIAL: HIGH TEMPERATURE NYLON, GLASS FILLED. UL94 V-0, COLOR REFER TO PAGE 54.
- PRODUCT CODES FOR 22AWG TO 26AWG UL REFERENCE E90723 (US AND CANADA). 28AWG HAS NOT YET GAINED APPROVAL.

PART NUMBER See page 54	WIRE GAUGE	B	A
00-9176-001-853-X06	22AWG Solid and Stranded	1.50	0.47
00-9176-001-863-X06	24AWG Solid and Stranded	1.50	0.37
00-9176-001-873-X06	26AWG Solid and Stranded	1.50	0.28
00-9176-001-884-X06	28AWG Solid and Stranded	0.90	0.20

### SUGGESTED PCB LAYOUT

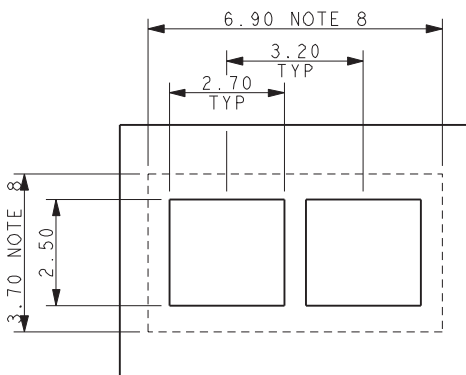

### PACKING DETAILS

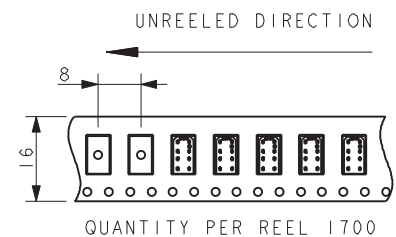
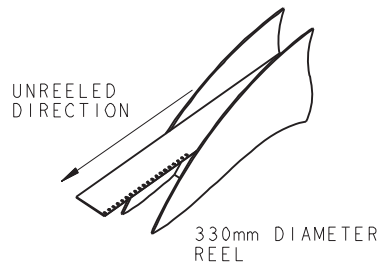

# Low Profile IDC 22-28AWG

9176-800

00-9176-001-8X3-X06

3 WAY

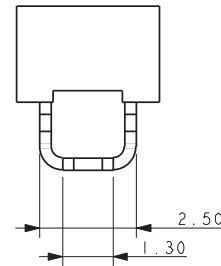
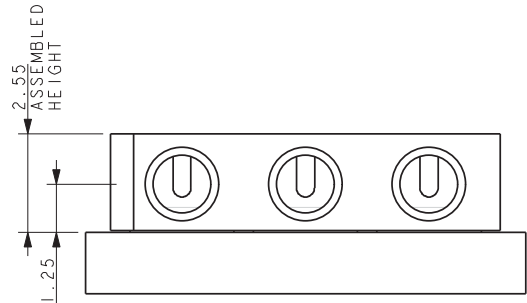
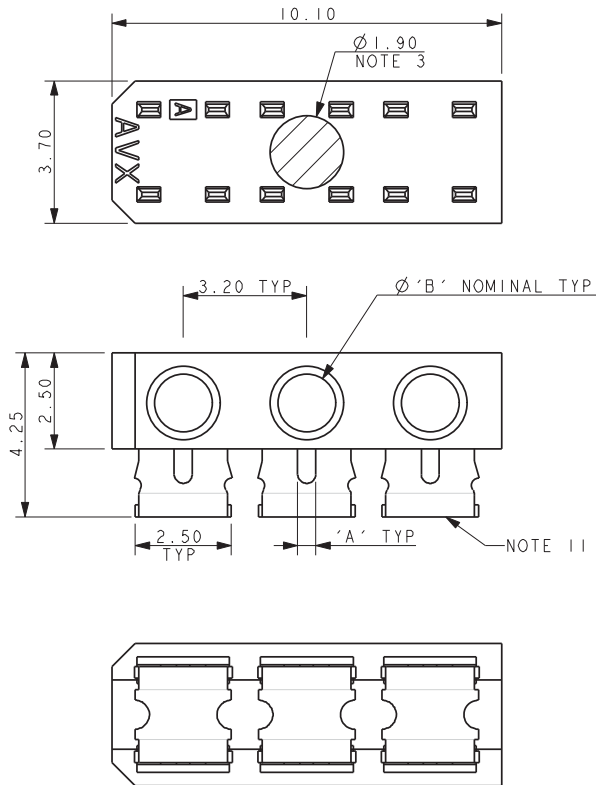

NOTES:

- 3 WAY CONNECTOR FOR IDC WIRE TO BOARD CONNECTOR.
- CONTACT/CAP TO MATCH 22AWG TO 26AWG STRANDED AND SOLID WIRE, MAXIMUM INSULATOR 1.40 DIAMETER. ALSO 28AWG WIRES OF MAXIMUM INSULATION 0.80MM DIAMETER.
- FLAT FACE ON TOP OF CAP TO AID PICK AND PLACE ASSEMBLY.
- FOR FULL PRODUCT SPECIFICATION REFER TO AVX SPEC 201-01-215.
- ASSEMBLY PROCEDURE, REFER TO APPLICATION NOTES 201-01-216.
- GENERAL TOLERANCE  $\pm 0.20$  UNLESS STATED.
- PACKED IN TAPE AND REEL, QUANTITY PER REEL 1700.
- CONNECTOR OUTLINE.
- CONTACT MATERIAL: TIN PLATED COPPER ALLOY.
- INSULATOR MATERIAL: HIGH TEMPERATURE NYLON, GLASS FILLED. UL94 V-0, COLOR REFER TO PAGE 54.
- PRODUCT CODES FOR 22AWG TO 26AWG UL REFERENCE E90723 (US AND CANDADA). 28AWG HAS NOT YET GAINED APPROVAL.

PART NUMBER See page 54	WIRE GAUGE	B	A
00-9176-001-853-X06	22AWG Solid and Stranded	1.50	0.47
00-9176-001-863-X06	24AWG Solid and Stranded	1.50	0.37
00-9176-001-873-X06	26AWG Solid and Stranded	1.50	0.28
00-9176-001-884-X06	28AWG Solid and Stranded	0.90	0.20

## SUGGESTED PCB LAYOUT

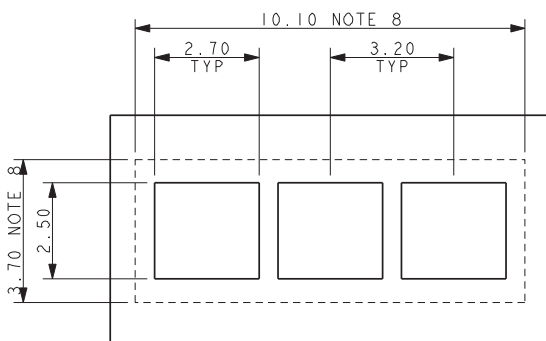

## PACKING DETAILS

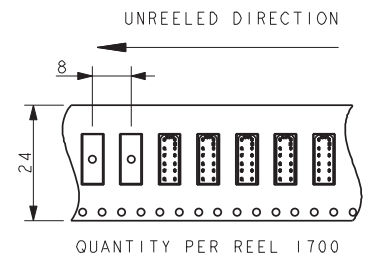
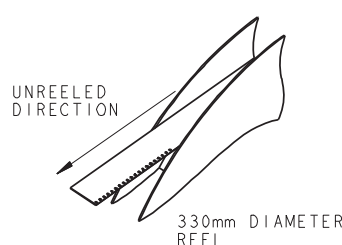

# Low Profile IDC 22-28AWG

9176-800

00-9176-001-8X3-X06

4 WAY

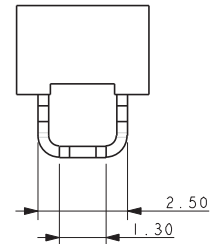
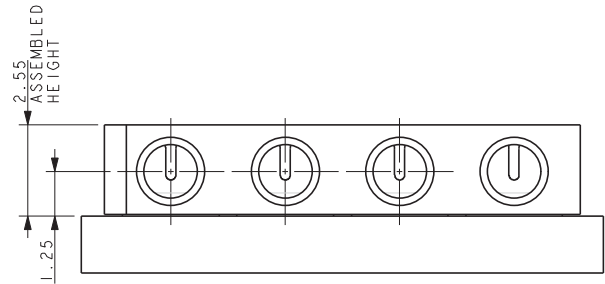
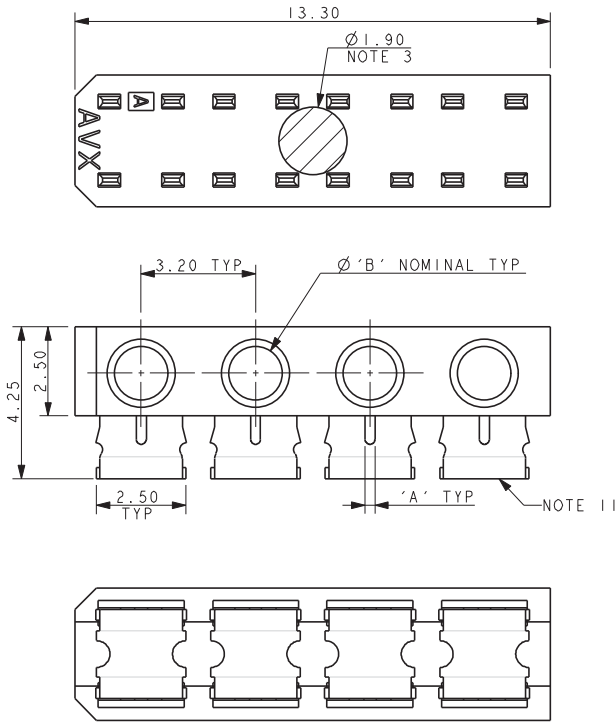

NOTES:

1. 4 WAY CONNECTOR FOR IDC WIRE TO BOARD CONNECTOR.
2. CONTACT/CAP TO MATCH 22AWG TO 26AWG STRANDED AND SOLID WIRE, MAXIMUM INSULATOR 1.40 DIAMETER. ALSO 28AWG WIRES OF MAXIMUM INSULATION 0.80MM DIAMETER.
3. FLAT FACE ON TOP OF CAP TO AID PICK AND PLACE ASSEMBLY.
4. FOR FULL PRODUCT SPECIFICATION REFER TO AVX SPEC 201-01-215.
5. ASSEMBLY PROCEDURE, REFER TO APPLICATION NOTES 201-01-216.
6. GENERAL TOLERANCE  $\pm 0.20$  UNLESS STATED.
7. PACKED IN TAPE AND REEL, QUANTITY PER REEL 1700.
8. CONNECTOR OUTLINE.
9. CONTACT MATERIAL: TIN PLATED COPPER ALLOY.
10. INSULATOR MATERIAL: HIGH TEMPERATURE NYLON, GLASS FILLED. UL94 V-0, COLOR REFER TO PAGE 54.
11. PRODUCT CODES FOR 22AWG TO 26AWG UL REFERENCE E90723 (US AND CANDADA). 28AWG HAS NOT YET GAINED APPROVAL.

PART NUMBER See page 54	WIRE GAUGE	B	A
00-9176-001-853-X06	22AWG Solid and Stranded	1.50	0.47
00-9176-001-863-X06	24AWG Solid and Stranded	1.50	0.37
00-9176-001-873-X06	26AWG Solid and Stranded	1.50	0.28
00-9176-001-884-X06	28AWG Solid and Stranded	0.90	0.20

## SUGGESTED PCB LAYOUT

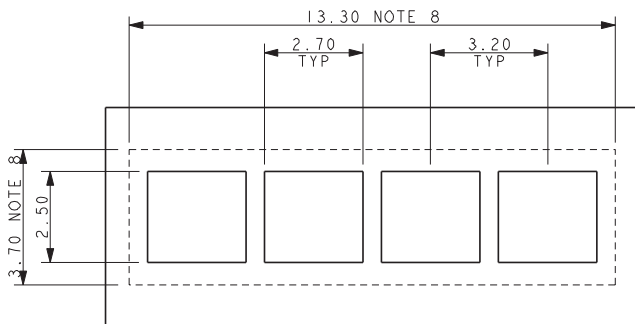

## PACKING DETAILS

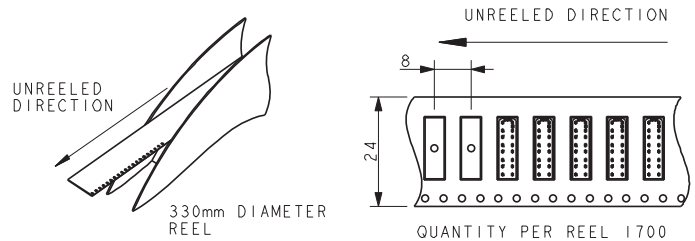

### CONNECTOR DETAILS

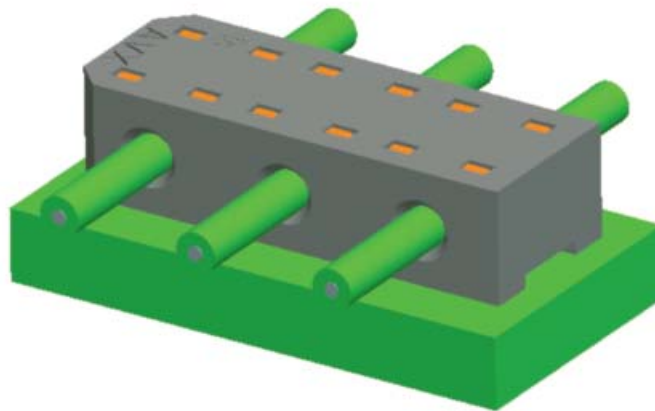
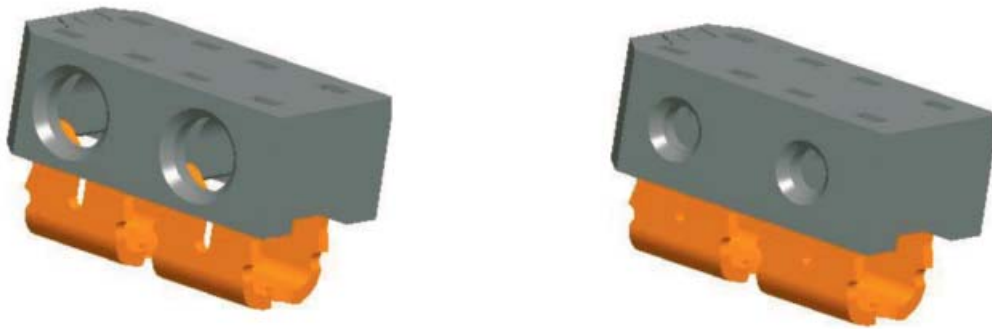

00-9176-00X-8X4-X06

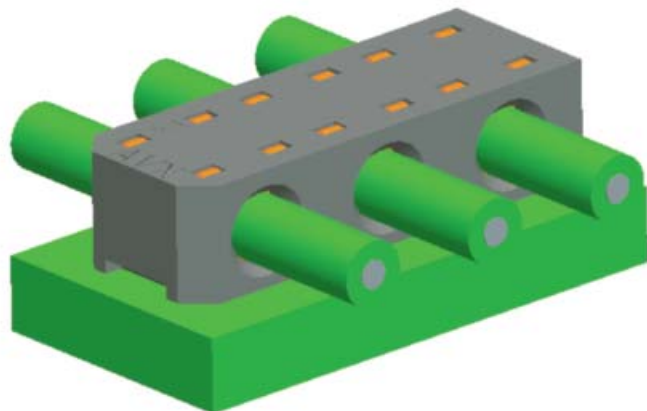

00-9176-00X-8X3-X06