



PJSD05LFN2

ESD PROTECTION DIODES

FEATURES

- IEC61000-4-2 Level 4 ESD Protection
- Lead free in compliance with EU RoHS2.0 (2011/65/EU & 2015/865/EU directive)
- Green molding compound as per IEC61249 Std. . (Halogen Free)

MECHANICAL DATA

- Case: DFN 2L, Plastic
- Terminals: Solderable per MIL-STD-750, Method 2026
- Weight: 0.00004 ounces, 0.0011grams
- Polarity : see cathode band

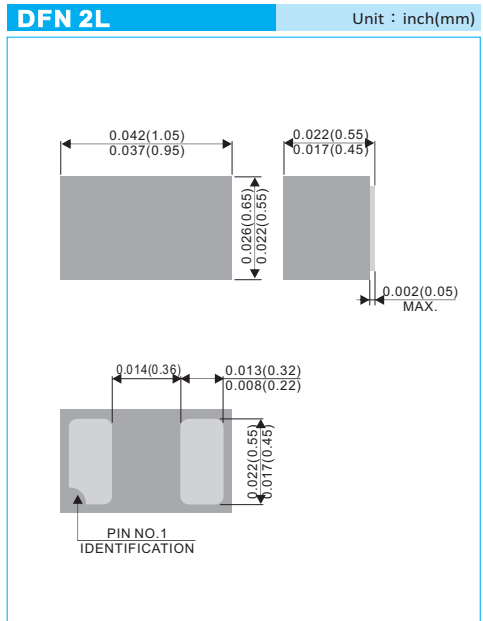
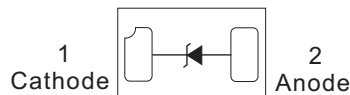

MAXIMUM RATINGS

Rating	Symbol	Value	Units
Total Power Dissipation on FR-4 Board (Note 1)@ $T_A=25^{\circ}\text{C}$	P_D	250	mW
Peak Power Dissipation 8/20 Surge Pulse	P_{PM}	40	W
Thermal Resistance Junction to Ambient	$R_{\theta JA}$	500	$^{\circ}\text{C/W}$
Lead Solder Temperature-Maximum (10 Second Duration)	T_L	260	$^{\circ}\text{C}$
Operating Junction and Storage Temperature Range	T_J, T_{STG}	-55 to +150	$^{\circ}\text{C}$

Stresses exceeding Maximum Ratings may damage the device. Maximum Rating are stress ratings only. Functional operation above the Recommended Operating Conditions is not implied. Extended exposure to stresses above the Recommended Operating Conditions may affect device reliability.

Note : 1.FR-4 = 70 x 60 x 1mm.



PJSD05LFN2

ELECTRICAL CHARACTERISTICS (TA=25°C unless otherwise noted)

Parameter	Symbol
Maximum Reverse Peak Pulse Current	I_{PP}
Clamping Voltage@ I_{PP}	V_C
Working Peak Reverse Voltage	V_{RWM}
Maximum Reverse Leakage Current@ V_{RWM}	I_R
Breakdown Voltage @ I_T	V_{BR}
Test Current	I_T
Forward Current	I_F
Forward Voltage@ I_F	V_F
Maximum Peak Power Dissipation	P_{PM}
Max.Capacitance@ $V_R=0$ and $f=1\text{MHz}$	C

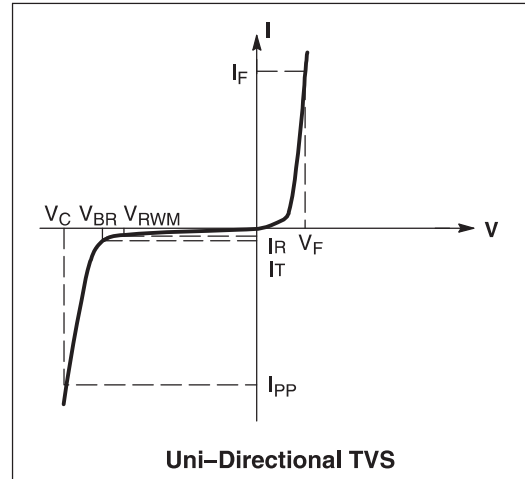

ELECTRICAL CHARACTERISTICS (TA=25°C unless otherwise noted)

Part Number	V_{RWM}	$I_R@V_{RWM}$	$V_{BR}@I_T$ (Note 2)	C (Note 3)	V_C	I_{PP}	I_T	Marking
	Max.	Max.	Min.	Max.	Max Per 8/20 μs			
	V	μA	V	pF	V			
PJSD05LFN2	5	1	6.2	35	9.8	4	1.0	BC

Note : 2. V_{BR} is measured with a pulse test current I_T at an ambient temperature of 25°C

3. Capacitance at $f=1\text{MHz}$, $V_R=0\text{V}$, $T_A=25^\circ\text{C}$



PJSD05LFN2

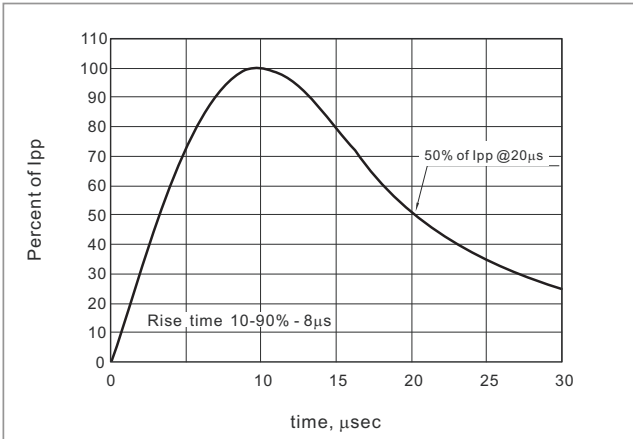

Fig.1 8/20µs Peak Pulse Current Waveform

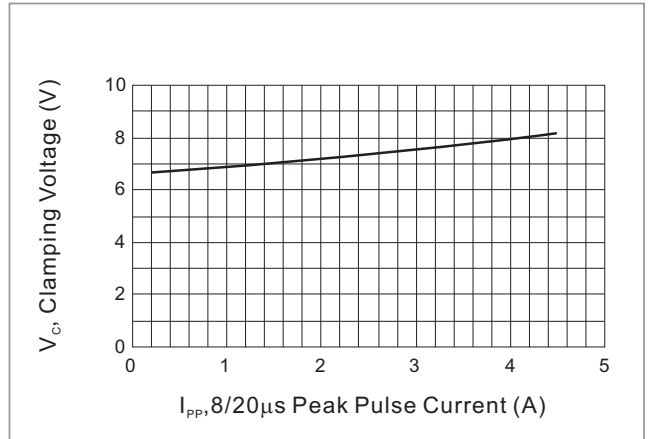

Fig.2 Typical Peak Clamping Voltage

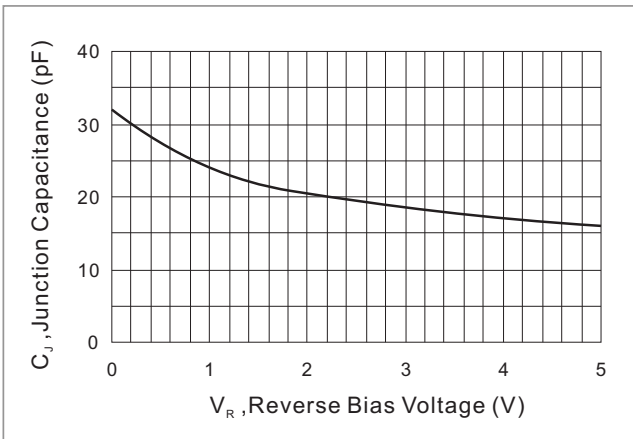

Fig.3 Typical Junction Capacitance

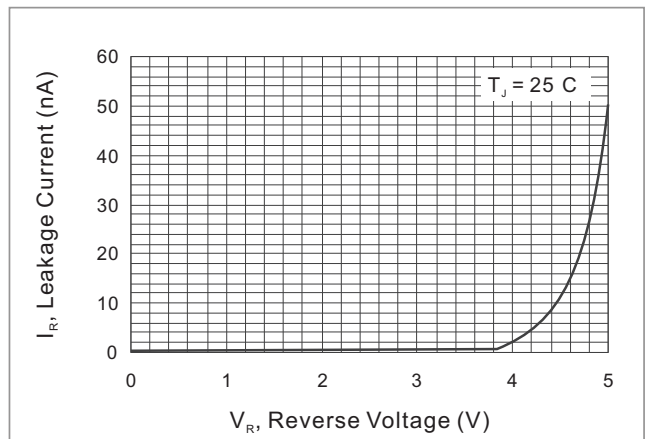

Fig.4 Typical Reverse Characteristics

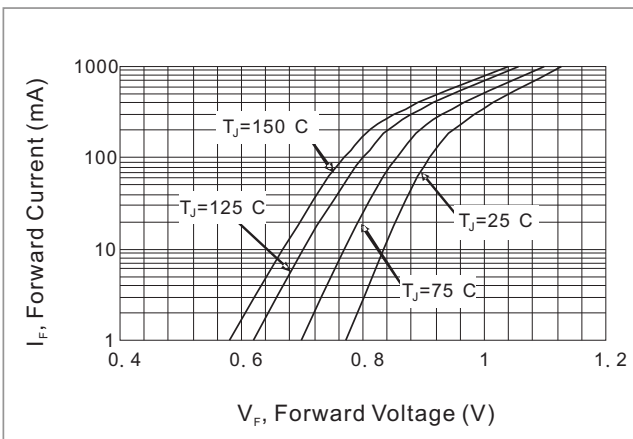

Fig.5 Typical Forward Characteristics

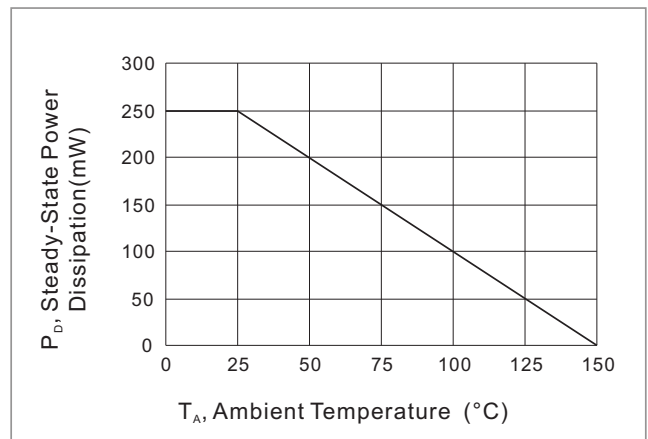

Fig.6 Power Derating Curve



PJSD05LFN2

MOUNTING PAD LAYOUT

DFN 2L

Unit : inch(mm)

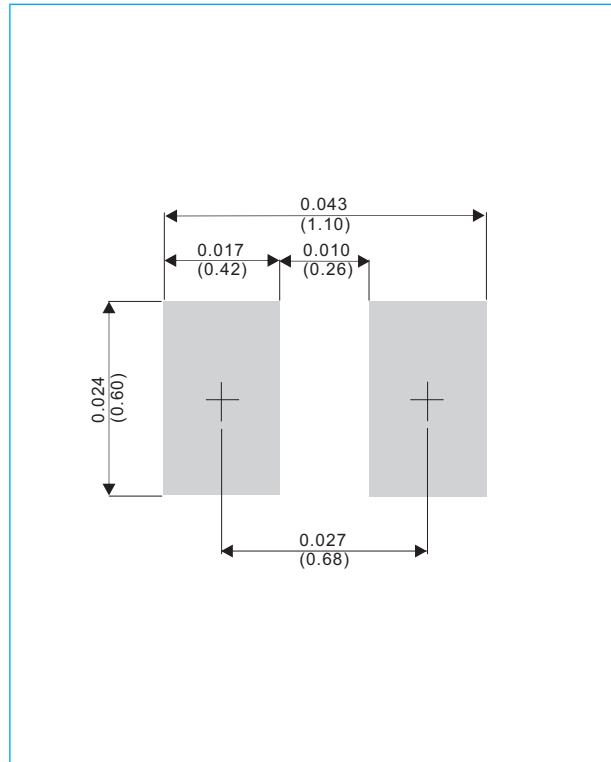

ORDER INFORMATION

- Packing information
T/R - 8K per 7" plastic Reel



PJSD05LFN2

Part No_packing code_Version
PJSD05LFN2_R1_00001

For example :

RB500V-40_R2_00001

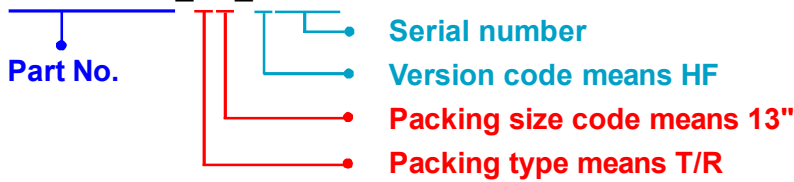

Packing Code XX				Version Code XXXXX		
Packing type	1 st Code	Packing size code	2 nd Code	HF or RoHS	1 st Code	2 nd ~5 th Code
Tape and Ammunition Box (T/B)	A	N/A	0	HF	0	serial number
Tape and Reel (T/R)	R	7"	1	RoHS	1	serial number
Bulk Packing (B/P)	B	13"	2			
Tube Packing (T/P)	T	26mm	X			
Tape and Reel (Right Oriented) (TRR)	S	52mm	Y			
Tape and Reel (Left Oriented) (TRL)	L	PANASERT T/B CATHODE UP (PBCU)	U			
FORMING	F	PANASERT T/B CATHODE DOWN (PBCD)	D			



PJSD05LFN2

Disclaimer

- Reproducing and modifying information of the document is prohibited without permission from Panjit International Inc..
- Panjit International Inc. reserves the rights to make changes of the content herein the document anytime without notification. Please refer to our website for the latest document.
- Panjit International Inc. disclaims any and all liability arising out of the application or use of any product including damages incidentally and consequentially occurred.
- Panjit International Inc. does not assume any and all implied warranties, including warranties of fitness for particular purpose, non-infringement and merchantability.
- Applications shown on the herein document are examples of standard use and operation. Customers are responsible in comprehending the suitable use in particular applications. Panjit International Inc. makes no representation or warranty that such applications will be suitable for the specified use without further testing or modification.
- The products shown herein are not designed and authorized for equipments requiring high level of reliability or relating to human life and for any applications concerning life-saving or life-sustaining, such as medical instruments, transportation equipment, aerospace machinery et cetera. Customers using or selling these products for use in such applications do so at their own risk and agree to fully indemnify Panjit International Inc. for any damages resulting from such improper use or sale.
- Since Panjit uses lot number as the tracking base, please provide the lot number for tracking when complaining.