

## Schematic for the NCL30073LED2GEVB Evaluation Board

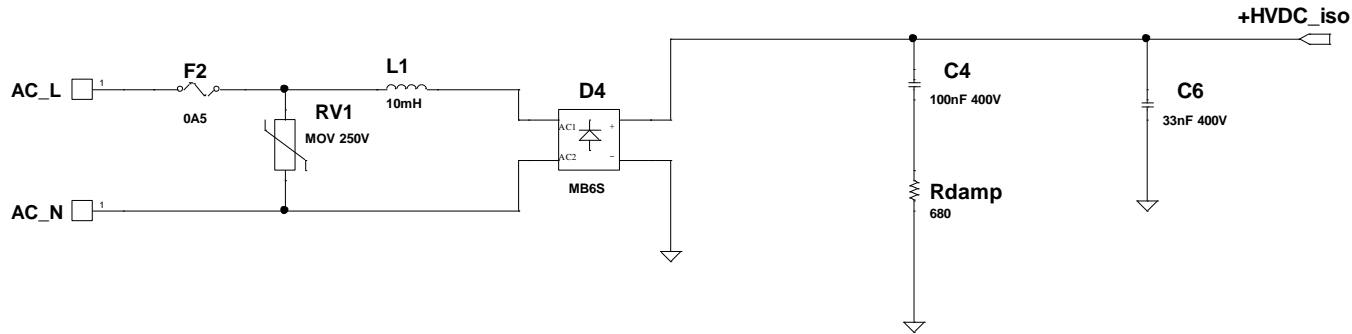

Figure 1. Input Circuit

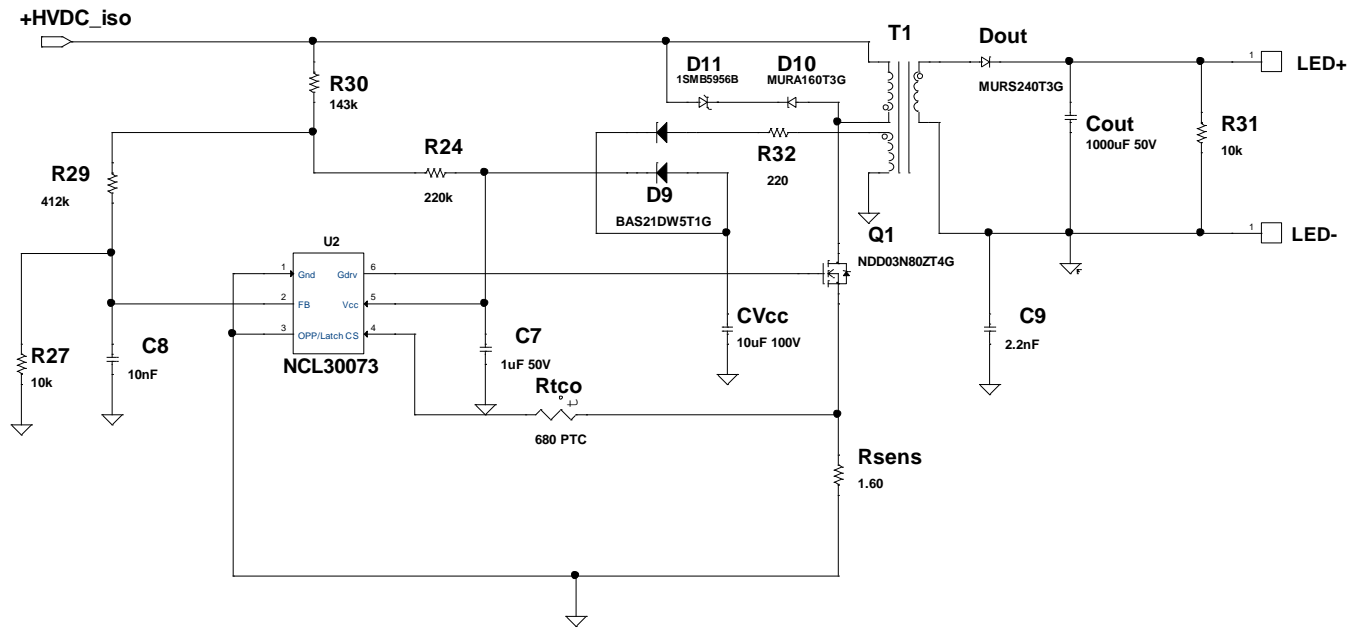

Figure 2. Main Schematic