

# ADS8284 18-BIT, 1-MSPS, Pseudo-Bipolar Differential SAR ADC with On-Chip ADC Driver (OPA) and 4-Channel Differential Multiplexer

## 1 Features

- 1.0-MHz Sample Rate, Zero Latency at Full Speed
- 18-Bit Resolution
- Supports Pseudo-Bipolar Differential Input Range: -4 V to +4 V with 2-V Common-Mode
- Built-In Four Channel, Differential Ended Multiplexer; with Channel Count Selection and Auto/Manual Mode
- On-Board Differential ADC Driver (OPA)
- Buffered Reference Output to Level Shift Bipolar  $\pm 4$ -V Input with External Resistance Divider
- Reference/2 Output to Set Common-Mode for External Signal Conditioner
- 18-/16-/8-Bit Parallel Interface
- SNR: 98.4dB Typ at 2-kHz I/P
- THD: -119dB Typ at 2-kHz I/P
- Power Dissipation: 331.25 mW at 1 MSPS Including ADC Driver
- Internal Reference
- Internal Reference Buffer
- 64-Pin QFN Package

## 2 Applications

- Medical Imaging/CT Scanners
- Automated Test Equipment
- High-Speed Data Acquisition Systems
- High-Speed Closed-Loop Systems

## 3 Description

The ADS8284 is a high-performance analog system-on-chip (SoC) device with an 18-bit, 1-MSPS A/D converter, 4-V internal reference, an on-chip ADC driver (OPA), and a 4-channel differential multiplexer. The channel count of the multiplexer and auto/manual scan modes of the device are user selectable.

The ADC driver is designed to leverage the very high noise performance of the differential ADC at optimum power usage levels.

The ADS8284 outputs a buffered reference signal for level shifting of a  $\pm 4$ -V bipolar signal with an external resistance divider. A  $V_{ref}/2$  output signal is available to set the common-mode of a signal conditioning circuit. The device also includes an 18-/16-/8-bit parallel interface.

The ADS8284 is available in a 9 mm x 9 mm, 64-pin QFN package and is characterized from -40°C to 85°C.

### Device Information (1)

DEVICE NAME	PACKAGE	BODY SIZE
ADS8284	QFN (64)	9mm x 9mm

(1) For all available packages, see the orderable addendum at the end of the data sheet.

### Simplified Schematic

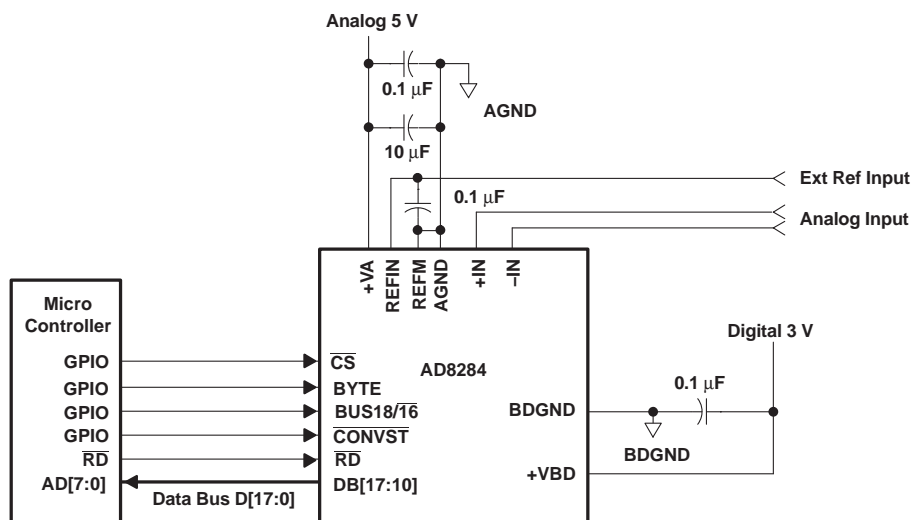

## Table of Contents

<b>1 Features</b> .....	<b>1</b>	6.10 Typical Characteristics .....	<b>19</b>
<b>2 Applications</b> .....	<b>1</b>	<b>7 Device Description</b> .....	<b>30</b>
<b>3 Description</b> .....	<b>1</b>	7.1 Overview .....	<b>30</b>
<b>4 Revision History</b> .....	<b>2</b>	7.2 Functional Block Diagram .....	<b>30</b>
<b>5 Pin Configuration and Function</b> .....	<b>3</b>	7.3 Feature Description.....	<b>31</b>
<b>6 Specifications</b> .....	<b>6</b>	7.4 Device Functional Modes.....	<b>32</b>
6.1 Absolute Maximum Ratings .....	<b>6</b>	<b>8 Application and Implementation</b> .....	<b>33</b>
6.2 Handling Ratings.....	<b>6</b>	8.1 Application Information.....	<b>33</b>
6.3 Recommended Operating Conditions.....	<b>6</b>	8.2 Typical Applications .....	<b>33</b>
6.4 Thermal Information .....	<b>6</b>	<b>9 Power Supply Recommendations</b> .....	<b>36</b>
6.5 Electrical Characteristics.....	<b>7</b>	<b>10 Device and Documentation Support</b> .....	<b>37</b>
6.6 Timing Requirements, 5 V .....	<b>10</b>	10.1 Trademarks .....	<b>37</b>
6.7 Timing Requirements, 3 V .....	<b>11</b>	10.2 Electrostatic Discharge Caution.....	<b>37</b>
6.8 Multiplexer Timing Requirements .....	<b>11</b>	10.3 Glossary .....	<b>37</b>
6.9 Timing Diagrams .....	<b>12</b>	<b>11 Mechanical, Packaging, and Orderable Information</b> .....	<b>37</b>

## 4 Revision History

Changes from Original (March 2009) to Revision A	Page
• Changed the data sheet to the new TI standard .....	<b>1</b>
• Added the Device Information table .....	<b>1</b>
• Added the Handling Ratings table.....	<b>6</b>
• Added Reference/2 Voltage Range to the Electrical Characteristics table .....	<b>8</b>
• Added the Power Supply Recommendations section .....	<b>36</b>

**Device Comparison Table**

TYPE/SPEED	500 kHz	~600 kHz	750 kHz	1 MHz	1.25 MHz	2 MHz	3 MHz	4MHz
18-Bit Pseudo-Diff	ADS8383	ADS8381		ADS8481				
		ADS8380 (s)						
18-Bit Pseudo-Bipolar, Fully Diff		ADS8382 (s)		ADS8284	ADS8484			
				ADS8482				
16-Bit Pseudo-Diff	ADS8327	ADS8370 (s)	ADS8371	ADS8471	ADS8401	ADS8411		
	ADS8328				ADS8405	ADS8410 (s)		
	ADS8319							
16-Bit Pseudo-Bipolar, Fully Diff	ADS8318	ADS8372 (s)		ADS8472	ADS8402	ADS8412		ADS8422
				ADS8254	ADS8406	ADS8413 (s)		
14-Bit Pseudo-Diff					ADS7890 (s)		ADS7891	
12-Bit Pseudo-Diff				ADS7886		ADS7883		ADS7881

**Device Linearity**

MODEL	MAXIMUM INTEGRAL LINEARITY (LSB)	MAXIMUM DIFFERENTIAL LINEARITY (LSB)	NO MISSING CODES AT RESOLUTION (BIT)
ADS8284IB	±2.5	+1.5/-1	18
ADS8284I	±4.5	+1.5/-1	18

**5 Pin Configuration and Function**

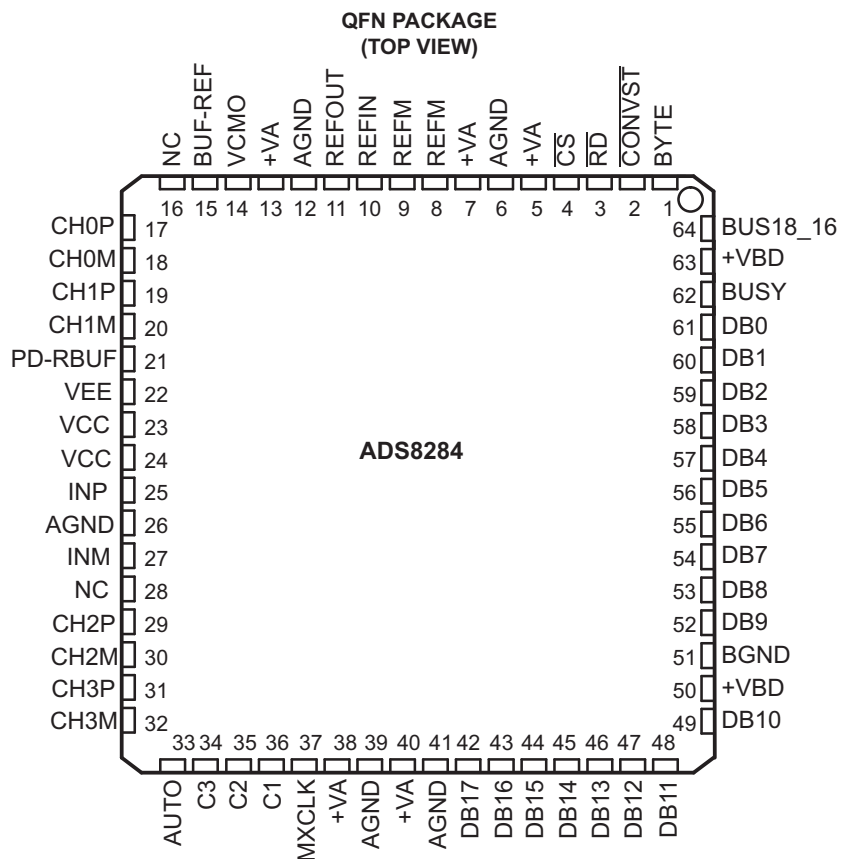

### Pin Functions

PIN		I/O	DESCRIPTION						
NO	NAME								
<b>MULTIPLEXER INPUT PINS</b>									
17	CH0P	I	Non-inverting analog input for differential multiplexer channel number 0. Device performance is optimized for 50-Ω source impedance at this input.						
18	CH0M	I	Inverting analog input for differential multiplexer channel number 0. Device performance is optimized for 50-Ω source impedance at this input.						
19	CH1P	I	Non-inverting analog input for differential multiplexer channel number 1. Device performance is optimized for 50-Ω source impedance at this input.						
20	CH1M	I	Inverting analog input for differential multiplexer channel number 1. Device performance is optimized for 50-Ω source impedance at this input.						
29	CH2P	I	Non-inverting analog input for differential multiplexer channel number 2. Device performance is optimized for 50-Ω source impedance at this input.						
30	CH2M	I	Inverting analog input for differential multiplexer channel number 2. Device performance is optimized for 50-Ω source impedance at this input.						
31	CH3P	I	Non-inverting analog input for differential multiplexer channel number 3. Device performance is optimized for 50 ohm source impedance at this input.						
32	CH3M	I	Inverting analog input for differential multiplexer channel number 3. Device performance is optimized for 50-Ω source impedance at this input.						
<b>ADC INPUT PINS</b>									
25	INP	I	ADC Non inverting input., connect 1-nF capacitor across INP and INM						
27	INM	I	ADC Inverting input, connect 1-nF capacitor across INP and INM						
<b>REFERENCE INPUT/ OUTPUT PINS</b>									
8, 9	REFM	I	Reference ground.						
10	REFIN	I	Reference Input. Add 0.1-μF decoupling capacitor between REFIN and REFM.						
11	REFOUT	O	Reference Output. Add 1-μF capacitor between the REFOUT pin and REFM pin when internal reference is used.						
14	VCMO	O	This pin outputs REFIN/2 and can be used to set common-mode voltage of differential analog inputs.						
15	BUF-REF	O	Buffered reference output. Useful to level shift bipolar signals using external resistors.						
<b>POWER CONTROL PINS</b>									
21	PD-RBUF	I	High on this pin powers down the reference buffer (BUF-REF).						
<b>MULTIPLEXER CONTROL PINS</b>									
33	AUTO	I	High level on this pin selects auto mode for multiplexer scanning. Low level selects manual mode of multiplexer scanning						
34	C3	I	In auto mode (AUTO = 1) multiplexer channel selection is reset to CH0 on rising edge of MXCLK while C3 = 1. The pin is do not care in manual mode.						
35	C2	I	Acts as multiplexer address bit when AUTO = 0 (manual mode). In auto mode (AUTO = 1) C2 and C1 select the last multiplexer channel (channel count) in the auto scan sequence.						
36	C1	I	Acts as multiplexer address LSB when AUTO = 0 (manual mode). In auto mode (AUTO = 1) C2 and C1 select the last multiplexer channel (channel count) in the auto scan sequence.						
37	MXCLK	I	Multiplexer channel is selected on rising edge of MXCLK irrespective of whether it is auto or manual mode. Device BUSY output can be connected to MXCLK so that device selects next channel at the end of every sample.						
<b>ADC DATA BUS</b>									
42-49, 52-61	Data Bus		8-BIT BUS			16-BIT BUS		18-BIT BUS	
			BYTE = 0	BYTE = 1	BYTE = 1	BYTE = 0	BYTE = 0	BYTE = 0	
			BUS18/16 = 0	BUS18/16 = 0	BUS18/16 = 1	BUS18/16 = 0	BUS18/16 = 1	BUS18/16 = 0	
42	DB17	O	D17 (MSB)	D9	All ones	D17 (MSB)	All ones	D17 (MSB)	
43	DB16	O	D16	D8	All ones	D16	All ones	D16	
44	DB15	O	D15	D7	All ones	D15	All ones	D15	
45	DB14	O	D14	D6	All ones	D14	All ones	D14	
46	DB13	O	D13	D5	All ones	D13	All ones	D13	
47	DB12	O	D12	D4	All ones	D12	All ones	D12	
48	DB11	O	D11	D3	D1	D11	All ones	D11	
49	DB10	O	D10	D2	D0 (LSB)	D10	All ones	D10	
52	DB9	O	D9	All ones	All ones	D9	All ones	D9	
53	DB8	O	D8	All ones	All ones	D8	All ones	D8	
54	DB7	O	D7	All ones	All ones	D7	All ones	D7	
55	DB6	O	D6	All ones	All ones	D6	All ones	D6	
56	DB5	O	D5	All ones	All ones	D5	All ones	D5	

**Pin Functions (continued)**

PIN		I/O	DESCRIPTION						
NO	NAME								
57	DB4	O	D4	All ones	All ones	D4	All ones	D4	
58	DB3	O	D3	All ones	All ones	D3	D1	D3	
59	DB2	O	D2	All ones	All ones	D2	D0 (LSB)	D2	
60	DB1	O	D1	All ones	All ones	D1	All ones	D1	
61	DB0	O	D0 (LSB)	All ones	All ones	D0 (LSB)	All ones	D0 (LSB)	
<b>ADC CONTROL PINS</b>									
62	BUSY	O	Status output. This pin is held high when device is converting.						
64	BUS18_16	I	Bus size select input. Used for selecting 18-bit or 16-bit wide bus transfer. Refer to ADC DATA BUS description above.						
1	BYTE	I	Byte Select Input. Used for 8-bit bus reading. Refer to ADC DATA BUS description above.						
2	$\overline{\text{CONVST}}$	I	Convert start. This input is active low and can act independent of the $\overline{\text{CS}}$ input.						
3	$\overline{\text{RD}}$	I	Synchronization pulse for the parallel output.						
4	$\overline{\text{CS}}$	I	Chip select.						
<b>DEVICE POWER SUPPLIES</b>									
22	VEE		Negative supply for OPA (OP1, OP2)						
23, 24	VCC		Positive supply for OPA (OP1, OP2, BUF-REF)						
5, 7, 13, 38, 40	+VA		Analog power supply.						
6, 12, 26, 39, 41	AGND		Analog ground.						
50, 63	+VBD		Digital power supply for ADC bus.						
51	BGND		Digital ground for ADC bus interface digital supply.						
<b>NOT CONNECTED PINS</b>									
16, 28	NC		No connection.						

## 6 Specifications

### 6.1 Absolute Maximum Ratings<sup>(1)</sup>

over operating free-air temperature range (unless otherwise noted)

	MIN	MAX	UNIT
CH(i) to AGND (both P and M inputs)	VEE–0.3	VCC + 0.3	V
VCC to VEE	–0.3	18	V
+VA to AGND	–0.3	7	V
+VBD to BDGND	–0.3	7	V
ADC control digital input voltage to GND	–0.3	(+VBD + 0.3)	V
ADC control digital output to GND	–0.3	(+VBD + 0.3)	V
Multiplexer control digital input voltage to GND	–0.3	(+VA + 0.3)	V
Power control digital input voltage to GND	–0.3	(+VCC + 0.3)	V
Operating temperature range	–40	85	°C
Junction temperature (T <sub>J,max</sub> )		150	°C

(1) Stresses beyond those listed under *absolute maximum ratings* may cause permanent damage to the device. These are stress ratings only, and functional operation of the device at these or any other conditions beyond those indicated under *recommended operating conditions* is not implied. Exposure to absolute-maximum-rated conditions for extended periods may affect device reliability.

### 6.2 Handling Ratings

	MIN	MAX	UNIT	
T <sub>stg</sub> Storage temperature range	–65	150	°C	
V <sub>(ESD)</sub> Electrostatic discharge	Human body model (HBM), per ANSI/ESDA/JEDEC JS-001, all pins <sup>(1)</sup>	–2	2	kV
	Charged device model (CDM), per JEDEC specification JESD22-C101, all pins <sup>(2)</sup>	–500	500	V

(1) JEDEC document JEP155 states that 500-V HBM allows safe manufacturing with a standard ESD control process.

(2) JEDEC document JEP157 states that 250-V CDM allows safe manufacturing with a standard ESD control process.

### 6.3 Recommended Operating Conditions

over operating free-air temperature range (unless otherwise noted)

		MIN	NOM	MAX	UNIT
Analog Input at Multiplexer Inputs	CHxP, CHxM	0		V <sub>REF</sub>	V
Digital Supply Voltage	+VBD	2.7	3.3	5.25	V
Analog Supply Voltage	+VA	4.75	5	5.25	V
Positive Supply Voltage for OPA	VCC	4.75	5	7.5	V
Negative Supply Voltage for OPA	VEE	–7.5	–5	–3	V

### 6.4 Thermal Information

THERMAL METRIC <sup>(1)</sup>		RCG	UNIT
		64 PINS	
R <sub>θJA</sub>	Junction-to-ambient thermal resistance	24.0	°C/W
R <sub>θJC(top)</sub>	Junction-to-case(top) thermal resistance	7.8	
R <sub>θJB</sub>	Junction-to-board thermal resistance	3.2	
ψ <sub>JT</sub>	Junction-to-top characterization parameter	0.1	
ψ <sub>JB</sub>	Junction-to-board characterization parameter	3.2	
R <sub>θJC(bottom)</sub>	Junction-to-case(bottom) thermal resistance	n/a	

(1) For more information about traditional and new thermal metrics, see the *IC Package Thermal Metrics* application report, [SPRA953](#).

## 6.5 Electrical Characteristics

$T_A = -40^{\circ}\text{C}$  to  $85^{\circ}\text{C}$ ,  $V_{CC} = 5\text{ V}$ ,  $V_{EE} = -5\text{ V}$ ,  $+V_A = 5\text{ V}$ ,  $+V_{BD} = 5\text{ V}$  or  $3.3\text{ V}$ ,  $V_{ref} = 4\text{ V}$ ,  $f_{SAMPLE} = 1\text{ MSPS}$  (unless otherwise noted)

PARAMETER		TEST CONDITIONS	MIN	TYP	MAX	UNIT
<b>ANALOG INPUT</b>						
Full-scale input voltage at multiplexer input <sup>(1)</sup>		CH(i)P–CH(i)M	$-V_{ref}$		$V_{ref}$	V
Absolute input range at multiplexer input		CH (i)	$-0.2$		$V_{ref} + 0.2$	V
Input common-mode voltage		$[\text{CH}(i)\text{P} + \text{CH}(i)\text{M}] / 2$	$(V_{ref})/2 - 0.2$	$(V_{ref})/2$	$(V_{ref})/2 + 0.2$	V
<b>SYSTEM PERFORMANCE</b>						
Resolution				18		Bits
No missing codes	ADS8284IB		18			Bits
	ADS8284I		18			
Integral linearity <sup>(2)</sup>	ADS8284IB		$-2.5$	$\pm 1.25$	2.5	LSB <sup>(3)</sup>
	ADS8284I		$-4.5$	$\pm 1.5$	4.5	
Differential linearity	ADS8284IB	At 18-bit level	$-1$	$\pm 0.6$	1.5	LSB <sup>(3)</sup>
	ADS8284I		$-1$	$\pm 0.6$	1.5	
Offset error	ADS8284IB		$-0.5$	$\pm 0.05$	0.5	mV
	ADS8284I		$-0.5$	$\pm 0.05$	0.5	
Gain error <sup>(4)</sup>	ADS8284IB	External reference	$-0.1$	$\pm 0.025$	0.1	%FS
	ADS8284I		$-0.1$	$\pm 0.025$	0.1	
DC power supply rejection ratio		At 3FFF <sub>0H</sub> output code. For +VA or VCC, VEE variation of 0.5 V individually		80		dB
<b>SAMPLING DYNAMICS</b>						
Conversion time	+VBD = 5 V			625	650	ns
	+VBD = 3 V			625	650	
Acquisition time	+VBD = 5 V		320	350		ns
	+VBD = 3 V		320	350		
Maximum throughput rate					1.0	MHz
Aperture delay				4		ns
Aperture jitter				5		ps
Settling time to 0.5 LSB	For ADC only			150		ns
	For OPA (OP1, OP2) + mux			700		
Over voltage recovery		For ADC only		150		ns
<b>DYNAMIC CHARACTERISTICS</b>						
Total harmonic distortion (THD) <sup>(5)</sup>	ADS8284I	$V_{IN} = 4 V_{pp}$ at 2 kHz		$-119$		dB
	ADS8284IB			$-119$		
	ADS8284I	$V_{IN} = 4 V_{pp}$ at 10 kHz		$-105$		dB
	ADS8284IB			$-105$		
	ADS8284I	$V_{IN} = 4 V_{pp}$ at 100 kHz, LoPWR = 0		$-100$		dB
	ADS8284IB			$-100$		
Signal-to-noise ratio (SNR)	ADS8284I	$V_{IN} = 4 V_{pp}$ at 2 kHz		98.4		dB
	ADS8284IB		97.5	98.4		
	ADS8284I	$V_{IN} = 4 V_{pp}$ at 10 kHz		98		dB
	ADS8284IB			98		
	ADS8284I	$V_{IN} = 4 V_{pp}$ at 100 kHz, LoPWR = 0		95		dB
	ADS8284IB			97		

- (1) Ideal input span, does not include gain or offset error.
- (2) This is endpoint INL, not best fit.
- (3) LSB means least significant bit.
- (4) Calculated on the first nine harmonics of the input frequency.
- (5) Measured relative to actual measured reference.

### Electrical Characteristics (continued)

T<sub>A</sub> = -40°C to 85°C, VCC = 5 V, VEE = -5 V, +VA = 5 V, +VBD = 5 V or 3.3 V, V<sub>ref</sub> = 4 V, f<sub>SAMPLE</sub> = 1 MSPS (unless otherwise noted)

PARAMETER		TEST CONDITIONS	MIN	TYP	MAX	UNIT
Signal-to-noise + distortion (SINAD)	ADS8284I	V <sub>IN</sub> = 4 V <sub>pp</sub> at 2 kHz	98.3			dB
	ADS8284IB		98.3			
	ADS8284I	V <sub>IN</sub> = 4 V <sub>pp</sub> at 10 kHz	97.2			dB
	ADS8284IB		97.2			
	ADS8284I	V <sub>IN</sub> = 4 V <sub>pp</sub> at 100 kHz, LoPWR = 0	93.8			dB
	ADS8284IB		95.23			
Spurious free dynamic range (SFDR)	ADS8284I	V <sub>IN</sub> = 4 V <sub>pp</sub> at 2 kHz	121			dB
	ADS8284IB		121			
	ADS8284I	V <sub>IN</sub> = 4 V <sub>pp</sub> at 10 kHz	106			dB
	ADS8284IB		106			
	ADS8284I	V <sub>IN</sub> = 4 V <sub>pp</sub> at 100 kHz, LoPWR = 0	101			dB
	ADS8284IB		101			
-3dB small signal bandwidth			8			MHz
<b>VOLTAGE REFERENCE INPUT (REFIN)</b>						
Reference voltage at REFIN, V <sub>ref</sub>			3.0	4.096	+VA - 0.8	V
Reference input current <sup>(6)</sup>				1	1	µA
<b>INTERNAL REFERENCE OUTPUT (REFOUT)</b>						
Internal reference start-up time		From 95% (+VA), with 1-µF storage capacitor			120	ms
Reference voltage range, V <sub>ref</sub>			4.081	4.096	4.111	V
Source current		Static load			10	µA
Line regulation		+VA = 4.75 V to 5.25 V		60		µV
Drift		I <sub>O</sub> = 0		±6		PPM/°C
<b>BUFFERED REFERENCE OUTPUT (BUF-REF)</b>						
Output current		REFIN = 4 V, at 85°C		70		mA
<b>REFERENCE/2 OUTPUT (VCMO)</b>						
Reference/2 Voltage Range		At No Load on VCMO	1.938	2.048	2.158	V
Output current		REFIN = 4 V, at +85°C		50		µA
<b>ANALOG MULTIPLEXER</b>						
Number of channels					4	
Channel to channel crosstalk		100 kHz i/p		-95		dB
Channel selection		Auto sequencer with selection of channel count or manual selection through control lines				
<b>DIGITAL INPUT-OUTPUT</b>						
<b>ADC CONTROL PINS</b>						
Logic Family-CMOS						
Logic level	V <sub>IH</sub>	I <sub>IH</sub> = 5 µA	+V <sub>BD</sub> -1		+V <sub>BD</sub> + 0.3	V
	V <sub>IL</sub>	I <sub>IL</sub> = 5 µA	0.3		0.8	V
	V <sub>OH</sub>	I <sub>OH</sub> = 2 TTL loads	+V <sub>BD</sub> -0.6		+V <sub>BD</sub>	V
	V <sub>OL</sub>	I <sub>OL</sub> = 2 TTL loads	0		0.4	V
<b>MULTIPLEXER CONTROL PINS</b>						
Logic Family - CMOS						
Logic level	I <sub>IH</sub>	I <sub>IH</sub> = 5 µA	2.3		+VA +0.3	V
	I <sub>IL</sub>	I <sub>IL</sub> = 5 µA	-0.3		0.8	V
<b>POWER CONTROL PINS</b>						
Logic Family - CMOS						
Logic level	V <sub>IH</sub>	I <sub>IH</sub> = 5 µA	2.3		+VA +0.3	V
	V <sub>IL</sub>	I <sub>IL</sub> = 5 µA	-0.3		0.8	V

(6) Can vary ±20%



**Electrical Characteristics (continued)**

$T_A = -40^{\circ}\text{C}$  to  $85^{\circ}\text{C}$ ,  $V_{CC} = 5\text{ V}$ ,  $V_{EE} = -5\text{ V}$ ,  $+V_A = 5\text{ V}$ ,  $+V_{BD} = 5\text{ V}$  or  $3.3\text{ V}$ ,  $V_{ref} = 4\text{ V}$ ,  $f_{SAMPLE} = 1\text{ MSPS}$  (unless otherwise noted)

PARAMETER	TEST CONDITIONS	MIN	TYP	MAX	UNIT
<b>POWER SUPPLY REQUIREMENTS</b>					
Power supply voltage	+VBD	2.7	3.3	5.25	V
	+VA	4.75	5	5.25	V
	VCC	4.75	5	7.5	V
	VEE	-7.5	-5	-3	V
ADC driver positive supply (VCC) current (for OP1 and OP2 together)	VCC = +5, VEE = -5V, CH0 - CH3 p and m inputs shorted to each other and connected to 2V		11.65		mA
ADC driver negative supply ( VEE) current (for OP1 and OP1 together)	VCC= +5V, CH0 - CH3 p and m inputs shorted to each other and connected to 2V		9.6		mA
+VA supply current, 1-MHz sample rate			45	50	mA
Reference buffer (BUF-REF) supply current (VCC to GND)	VCC= +5, PD-RBUF = 0, Quiescent current		8		mA
	VCC = 5, PD-RBUF = 1 <sup>(7)</sup>		10		$\mu\text{A}$
<b>TEMPERATURE RANGE</b>					
Operating free-air		-40		85	$^{\circ}\text{C}$

(7) PD-RBUF = 1 powers down the reference buffer (BUF-REF), note that it does not 3-state the BUF-REF output.

## 6.6 Timing Requirements, 5 V

All specifications typical at  $-40^{\circ}\text{C}$  to  $85^{\circ}\text{C}$ ,  $+V_A = +V_{BD} = 5\text{ V}$  <sup>(1)</sup> <sup>(2)</sup> <sup>(3)</sup>

PARAMETER		MIN	TYP	MAX	UNIT
$t_{(\text{CONV})}$	Conversion time			650	ns
$t_{(\text{ACQ})}$	Acquisition time	320			ns
$t_{(\text{HOLD})}$	Sample capacitor hold time			25	ns
$t_{\text{pd1}}$	$\overline{\text{CONVST}}$ low to BUSY high			40	ns
$t_{\text{pd2}}$	Propagation delay time, end of conversion to BUSY low			15	ns
$t_{\text{pd3}}$	Propagation delay time, start of convert state to rising edge of BUSY			15	ns
$t_{\text{w1}}$	Pulse duration, $\overline{\text{CONVST}}$ low	40			ns
$t_{\text{su1}}$	Setup time, $\overline{\text{CS}}$ low to $\overline{\text{CONVST}}$ low	20			ns
$t_{\text{w2}}$	Pulse duration, $\overline{\text{CONVST}}$ high	20			ns
	$\overline{\text{CONVST}}$ falling edge jitter			10	ps
$t_{\text{w3}}$	Pulse duration, BUSY signal low	$t_{(\text{ACQ})\text{min}}$			ns
$t_{\text{w4}}$	Pulse duration, BUSY signal high			650	ns
$t_{\text{h1}}$	Hold time, first data bus transition ( $\overline{\text{RD}}$ low, or $\overline{\text{CS}}$ low for read cycle, or BYTE or BUS18/16 input changes) after $\overline{\text{CONVST}}$ low	40			ns
$t_{\text{d1}}$	Delay time, $\overline{\text{CS}}$ low to $\overline{\text{RD}}$ low	0			ns
$t_{\text{su2}}$	Setup time, $\overline{\text{RD}}$ high to $\overline{\text{CS}}$ high	0			ns
$t_{\text{w5}}$	Pulse duration, $\overline{\text{RD}}$ low	50			ns
$t_{\text{en}}$	Enable time, $\overline{\text{RD}}$ low (or $\overline{\text{CS}}$ low for read cycle) to data valid			20	ns
$t_{\text{d2}}$	Delay time, data hold from $\overline{\text{RD}}$ high	5			ns
$t_{\text{d3}}$	Delay time, BUS18/16 or BYTE rising edge or falling edge to data valid	10		20	ns
$t_{\text{w6}}$	Pulse duration, $\overline{\text{RD}}$ high	20			ns
$t_{\text{w7}}$	Pulse duration, $\overline{\text{CS}}$ high	20			ns
$t_{\text{h2}}$	Hold time, last $\overline{\text{RD}}$ (or $\overline{\text{CS}}$ for read cycle) rising edge to $\overline{\text{CONVST}}$ falling edge	50			ns
$t_{\text{pd4}}$	Propagation delay time, BUSY falling edge to next $\overline{\text{RD}}$ (or $\overline{\text{CS}}$ for read cycle) falling edge	0			ns
$t_{\text{d4}}$	Delay time, BYTE edge to BUS18/16 edge skew	0			ns
$t_{\text{su3}}$	Setup time, BYTE or BUS18/16 transition to $\overline{\text{RD}}$ falling edge	10			ns
$t_{\text{h3}}$	Hold time, BYTE or BUS18/16 transition to $\overline{\text{RD}}$ falling edge	10			ns
$t_{\text{dis}}$	Disable time, $\overline{\text{RD}}$ high ( $\overline{\text{CS}}$ high for read cycle) to 3-stated data bus			20	ns
$t_{\text{d5}}$	Delay time, BUSY low to MSB data valid delay			0	ns
$t_{\text{d6}}$	Delay time, $\overline{\text{CS}}$ rising edge to BUSY falling edge	50			ns
$t_{\text{d7}}$	Delay time, BUSY falling edge to $\overline{\text{CS}}$ rising edge	50			ns
$t_{\text{su5}}$	BYTE transition setup time, from BYTE transition to next BYTE transition, or BUS18/16 transition setup time, from BUS18/16 to next BUS18/16.	50			ns
$t_{\text{su}(\text{ABORT})}$	Setup time from the falling edge of $\overline{\text{CONVST}}$ (used to start the valid conversion) to the next falling edge of $\overline{\text{CONVST}}$ (when $\text{CS} = 0$ and $\overline{\text{CONVST}}$ are used to abort) or to the next falling edge of $\overline{\text{CS}}$ (when $\overline{\text{CS}}$ is used to abort).	60		550	ns

- (1) All input signals are specified with  $t_r = t_f = 5\text{ ns}$  (10% to 90% of  $+V_{BD}$ ) and timed from a voltage level of  $(V_{IL} + V_{IH})/2$ .
- (2) See timing diagrams.
- (3) All timing are measured with 20 pF equivalent loads on all data bits and BUSY pins.

## 6.7 Timing Requirements, 3 V

 All specifications typical at  $-40^{\circ}\text{C}$  to  $85^{\circ}\text{C}$ ,  $+V_A = 5\text{ V}$   $+V_{BD} = 3\text{ V}$  <sup>(1)</sup> <sup>(2)</sup> <sup>(3)</sup>

PARAMETER		MIN	TYP	MAX	UNIT
$t_{(\text{CONV})}$	Conversion time			650	ns
$t_{(\text{ACQ})}$	Acquisition time	320			ns
$t_{(\text{HOLD})}$	Sample capacitor hold time			25	ns
$t_{\text{pd1}}$	$\overline{\text{CONVST}}$ low to BUSY high			40	ns
$t_{\text{pd2}}$	Propagation delay time, end of conversion to BUSY low			25	ns
$t_{\text{pd3}}$	Propagation delay time, start of convert state to rising edge of BUSY			25	ns
$t_{\text{w1}}$	Pulse duration, $\overline{\text{CONVST}}$ low	40			ns
$t_{\text{su1}}$	Setup time, $\overline{\text{CS}}$ low to $\overline{\text{CONVST}}$ low	20			ns
$t_{\text{w2}}$	Pulse duration, CONVST high	20			ns
	$\overline{\text{CONVST}}$ falling edge jitter			10	ps
$t_{\text{w3}}$	Pulse duration, BUSY signal low	$t_{(\text{ACQ})\text{min}}$			ns
$t_{\text{w4}}$	Pulse duration, BUSY signal high			650	ns
$t_{\text{h1}}$	Hold time, first data bus transition ( $\overline{\text{RD}}$ low, or $\overline{\text{CS}}$ low for read cycle, or BYTE or BUS18/16 input changes) after $\overline{\text{CONVST}}$ low	40			ns
$t_{\text{d1}}$	Delay time, $\overline{\text{CS}}$ low to $\overline{\text{RD}}$ low	0			ns
$t_{\text{su2}}$	Setup time, $\overline{\text{RD}}$ high to $\overline{\text{CS}}$ high	0			ns
$t_{\text{w5}}$	Pulse duration, $\overline{\text{RD}}$ low	50			ns
$t_{\text{en}}$	Enable time, $\overline{\text{RD}}$ low (or $\overline{\text{CS}}$ low for read cycle) to data valid			30	ns
$t_{\text{d2}}$	Delay time, data hold from $\overline{\text{RD}}$ high	5			ns
$t_{\text{d3}}$	Delay time, BUS18/16 or BYTE rising edge or falling edge to data valid	10		30	ns
$t_{\text{w6}}$	Pulse duration, $\overline{\text{RD}}$ high	20			ns
$t_{\text{w7}}$	Pulse duration, $\overline{\text{CS}}$ high	20			ns
$t_{\text{h2}}$	Hold time, last $\overline{\text{RD}}$ (or $\overline{\text{CS}}$ for read cycle) rising edge to $\overline{\text{CONVST}}$ falling edge	50			ns
$t_{\text{pd4}}$	Propagation delay time, BUSY falling edge to next $\overline{\text{RD}}$ (or $\overline{\text{CS}}$ for read cycle) falling edge	0			ns
$t_{\text{d4}}$	Delay time, BYTE edge to BUS18/16 edge skew	0			ns
$t_{\text{su3}}$	Setup time, BYTE or BUS18/16 transition to $\overline{\text{RD}}$ falling edge	10			ns
$t_{\text{h3}}$	Hold time, BYTE or BUS18/16 transition to $\overline{\text{RD}}$ falling edge	10			ns
$t_{\text{dis}}$	Disable time, $\overline{\text{RD}}$ high ( $\overline{\text{CS}}$ high for read cycle) to 3-stated data bus			30	ns
$t_{\text{d5}}$	Delay time, BUSY low to MSB data valid delay			0	ns
$t_{\text{d6}}$	Delay time, $\overline{\text{CS}}$ rising edge to BUSY falling edge	50			ns
$t_{\text{d7}}$	Delay time, BUSY falling edge to $\overline{\text{CS}}$ rising edge	50			ns
$t_{\text{su5}}$	BYTE transition setup time, from BYTE transition to next BYTE transition, or BUS18/16 transition setup time, from BUS18/16 to next BUS18/16.	50			ns
$t_{\text{su}(\text{ABORT})}$	Setup time from the falling edge of $\overline{\text{CONVST}}$ (used to start the valid conversion) to the next falling edge of CONVST (when CS = 0 and CONVST are used to abort) or to the next falling edge of $\overline{\text{CS}}$ (when $\overline{\text{CS}}$ is used to abort).	70		550	ns

 (1) All input signals are specified with  $t_r = t_f = 5\text{ ns}$  (10% to 90% of  $+V_{BD}$ ) and timed from a voltage level of  $(V_{IL} + V_{IH})/2$ .

(2) See timing diagrams.

(3) All timing are measured with 20-pF equivalent loads on all data bits and BUSY pins.

## 6.8 Multiplexer Timing Requirements

 $V_{CC} = 4.75\text{ V}$  to  $7.5\text{ V}$ ,  $V_{EE} = -3\text{ V}$  to  $-7.5\text{ V}$ 

		MIN	TYP	MAX	UNIT
$t_{\text{su6}}$	Setup time C1, C2 or C3 to MXCLK rising edge			600	ns
$t_{\text{d8}}$	Multiplexer and driver settle time ( from MXCLK rising edge to $\overline{\text{CONVST}}$ falling edge)	600			ns

## 6.9 Timing Diagrams

The ADS8284 is analog system-on-chip (SoC) device. The device includes a multiplexer, a differential input/differential output ADC driver and differential input high-performance ADC, an additional internal reference, a buffered reference output, and a REF/2 output.

Figure 1 shows the basic operation of the device (including all elements). Subsequent sections describe the detailed timings of the individual blocks of the device (primarily the multiplexer and ADC).

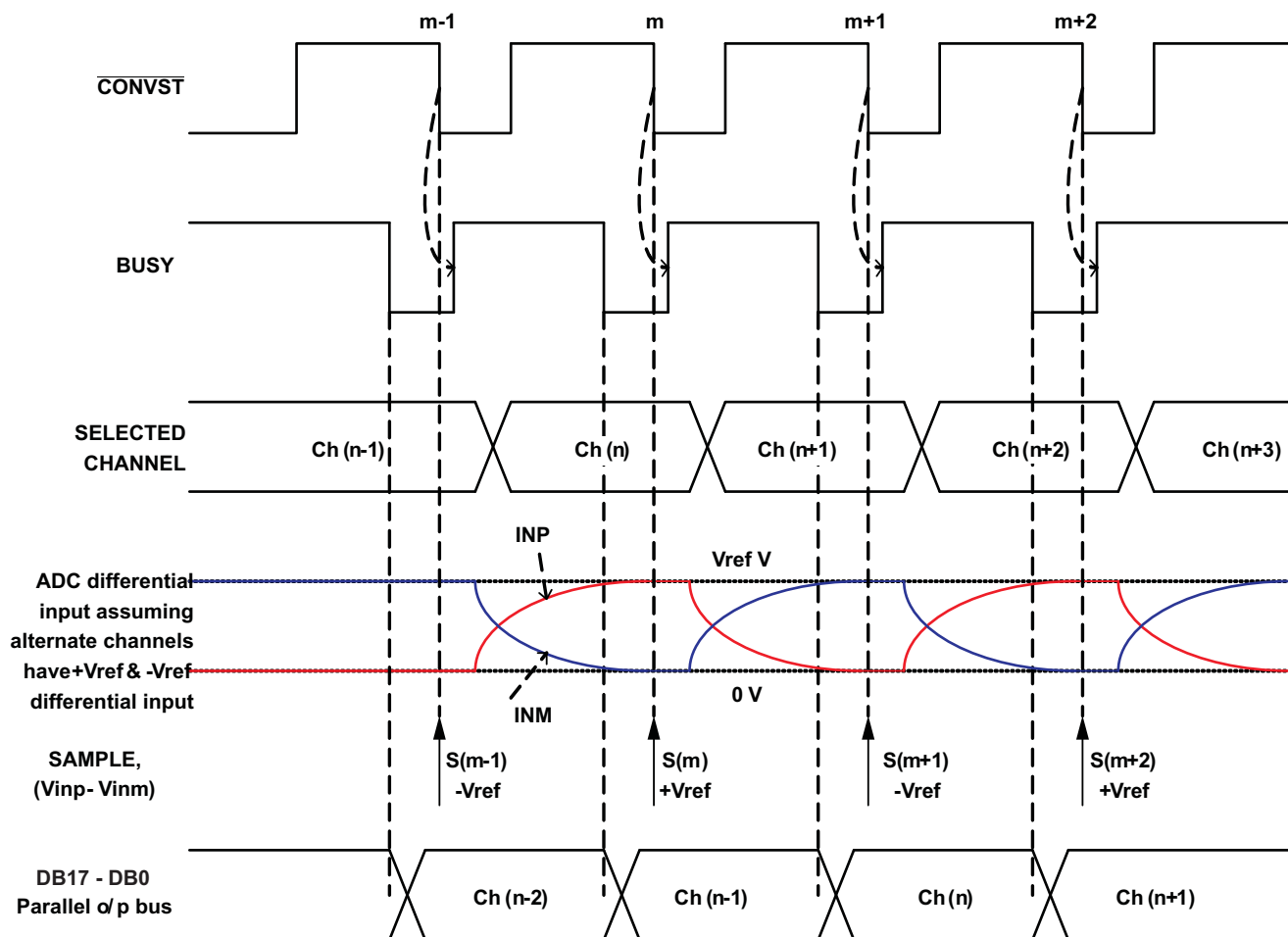

Figure 1. Device Operation

As shown in the diagram, the device can be controlled with only one ( $\overline{CONVST}$ ) digital input. On the falling edge of  $\overline{CONVST}$ , the  $BUSY$  output of the device goes high. A high level on  $BUSY$  indicates the device has sampled the signal and it is converting the sample into its digital equivalent. After the conversion is complete, the  $BUSY$  output falls to a logic low level and the device output data corresponding to the recently converted sample is available for reading.

It is recommended (not mandatory) to short the  $BUSY$  output of the device to the  $MXCLK$  input. The device selects a new channel at every rising edge of  $MXCLK$ . The multiplexer is differential. The multiplexer and ADC driver are designed to settle to the 18-bit level before sampling; even at the maximum conversion speed.

**ADC control and timing:** The timing diagrams in this section describe ADC operation; multiplexer operation is described in a later section.

Timing Diagrams (continued)

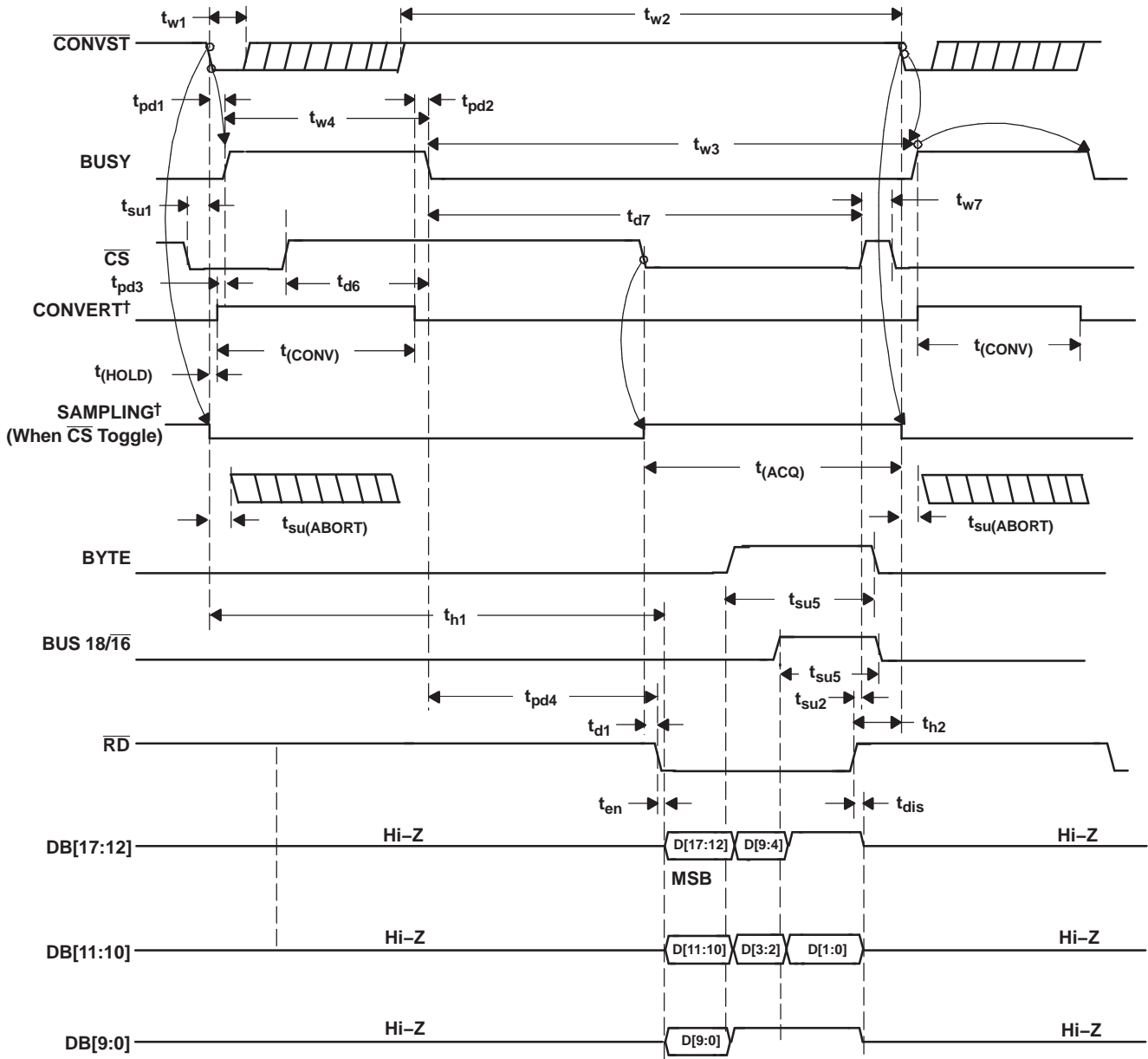

†Signal internal to device

Figure 2. Timing for Conversion and Acquisition Cycles with CS and RD Toggling



**Timing Diagrams (continued)**

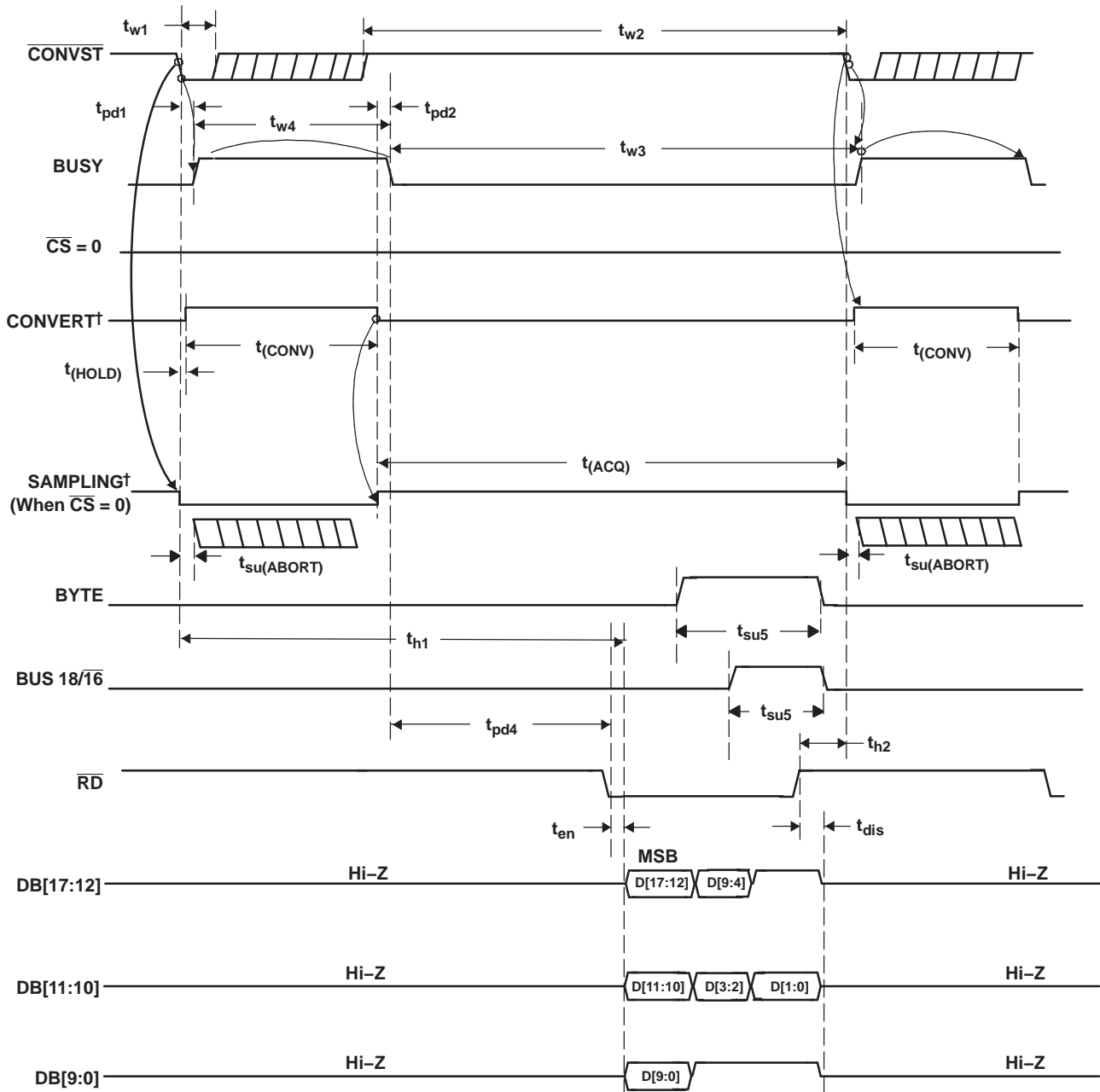

†Signal internal to device

**Figure 4. Timing for Conversion and Acquisition Cycles With  $\overline{CS}$  Tied to BDGND,  $\overline{RD}$  Toggling**

Timing Diagrams (continued)

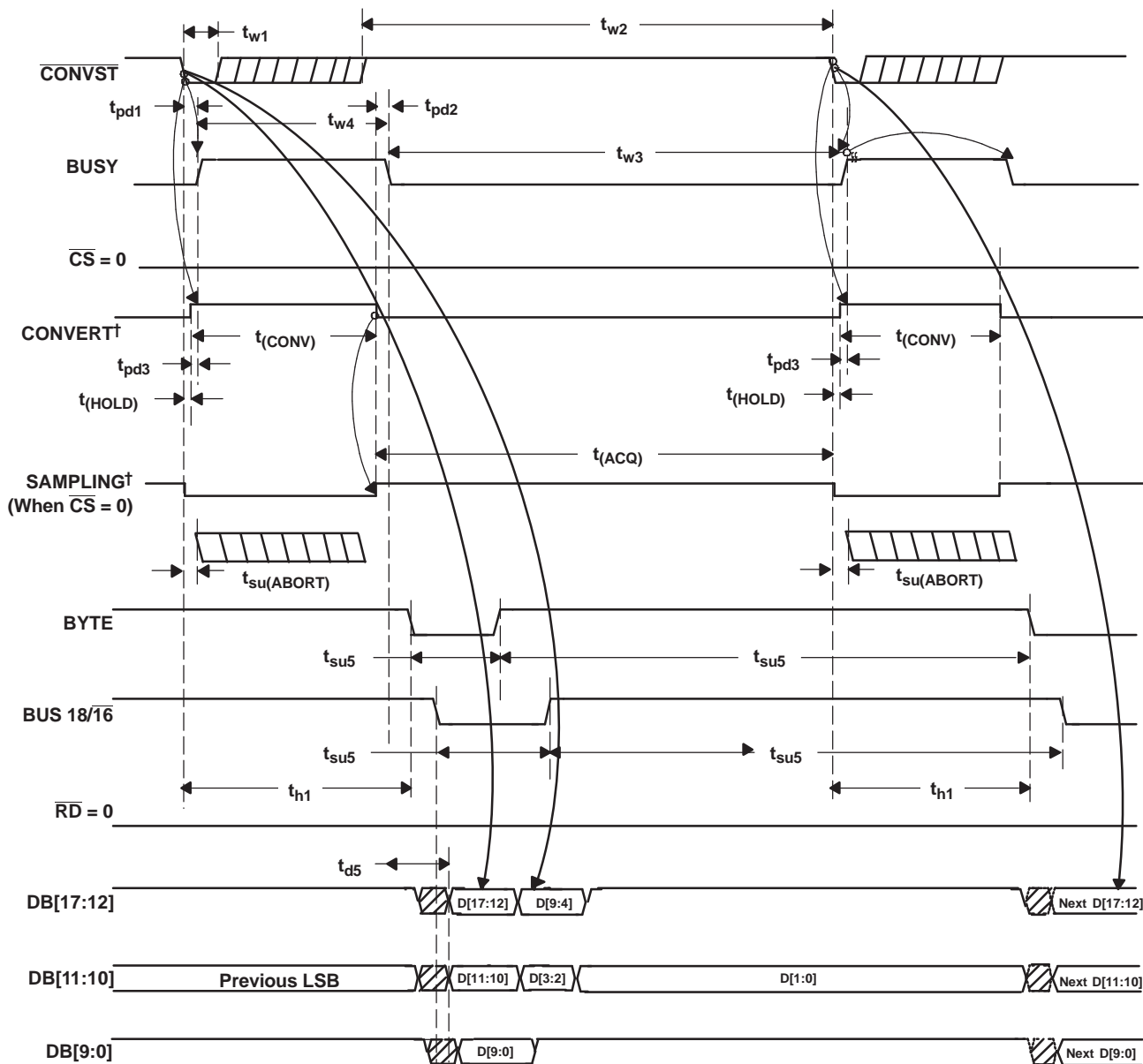

†Signal internal to device

Figure 5. Timing for Conversion and Acquisition Cycles With  $\overline{CS}$  and  $\overline{RD}$  Tied to BDGND - Auto Read



Timing Diagrams (continued)

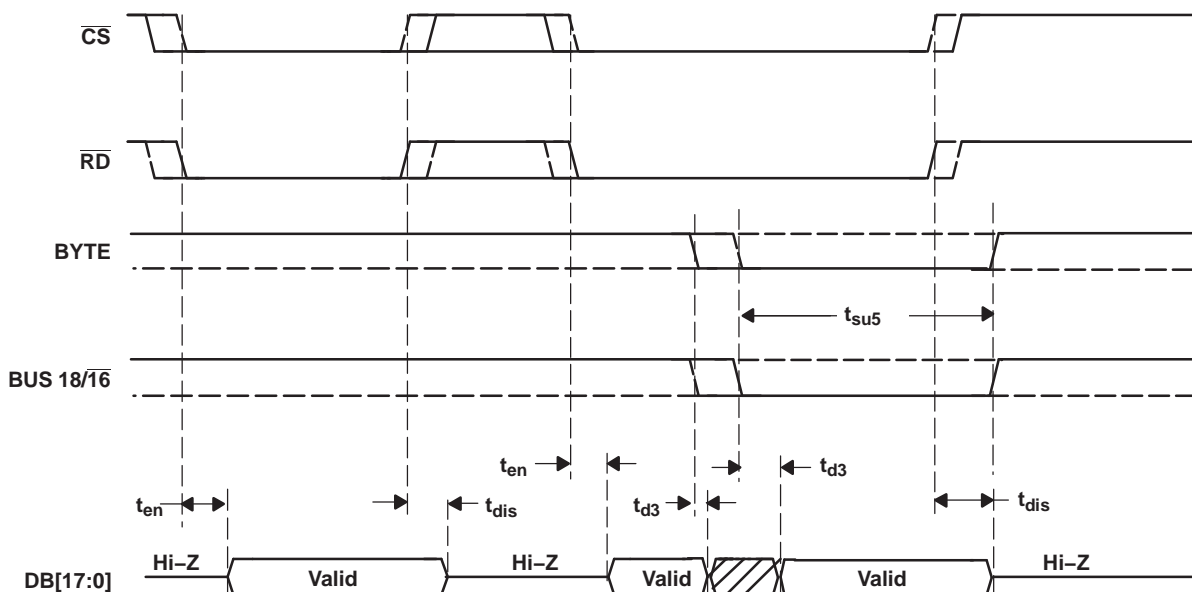

Figure 6. Detailed Timing for Read Cycles

**Multiplexer:** The multiplexer has two modes of sequencing namely auto sequencing and manual sequencing. Multiplexer mode selection and operation is controlled with the AUTO, C1, C2, C3, and MXCLK pin.

**Auto sequencing:** A logic one level on the AUTO pin selects auto sequencing mode. It is possible to select the number of channels to be scanned (always starting from channel zero) in auto sequencing mode. Pins C1 and C2 select the channel count (last channel in the auto sequence).

On every rising edge of MXCLK while C3 is at the logic zero level, the next higher channel (in ascending order) is selected. Channel selection rolls over to channel zero on the rising edge of MXCLK after channel selection reaches the *channel count* (last channel in the auto sequence selected by pins C1 and C2).

Any time during the sequence the channel sequence can be reset to channel zero. A rising edge on MXCLK while C3 is at the logic one level resets channel selection to channel zero.

Table 1. Channel Selection in Auto Mode

CHANNEL COUNT PINS			CLOCK PIN	LAST CHANNEL IN SEQUENCE	CHANNEL SEQUENCE
C3	C2	C1	MXCLK		
0	0	0	↑	0	0,0,0,0..
0	0	1	↑	1	0,1,0,1,..
0	1	0	↑	2	0,1,2,0,1,2,0...
0	1	1	↑	3	0,1,2,3,0,1,2,3,0...
1	X	X	↑	X	n → 0 (channel reset to zero)

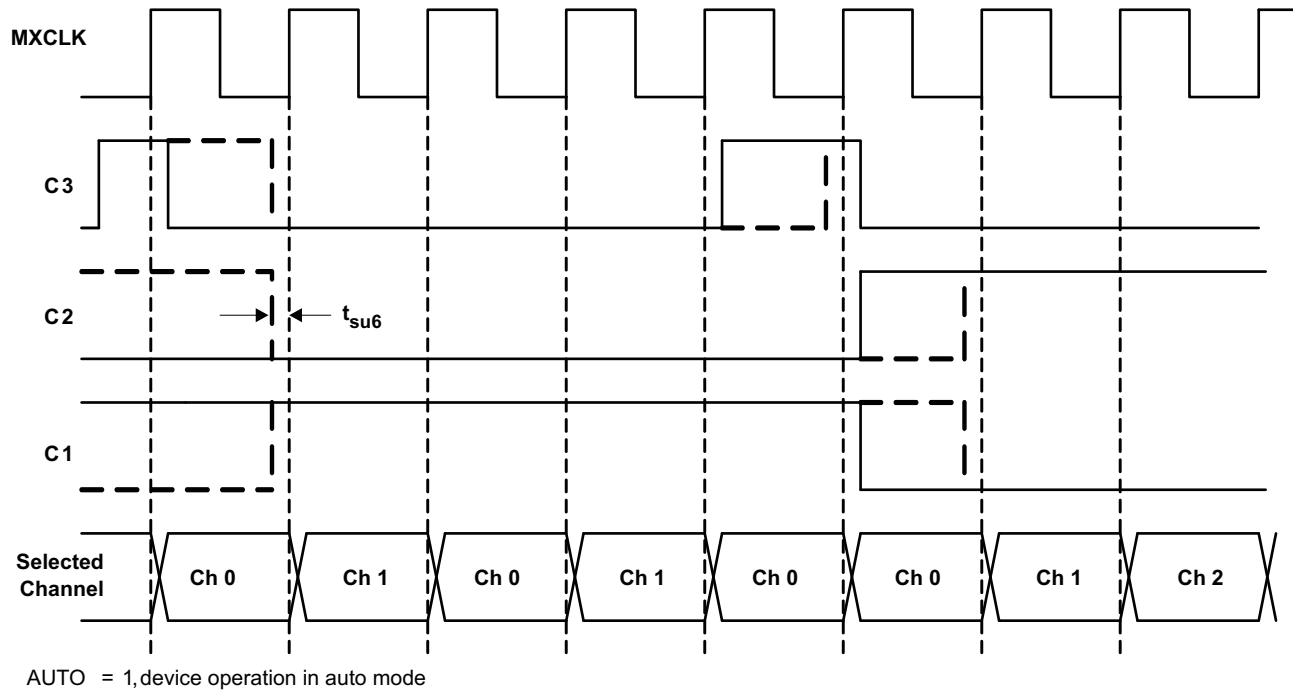

Figure 7. Multiplier Auto Mode Timing Diagram

**Manual sequencing:** A logic zero level on the AUTO pin selects manual sequencing mode. Pins C1 and C2 set the channel address. On the rising edge of MXCLK, the addressed channel is connected to the ADC driver input.

Table 2. Channel Selection in Manual Mode

MODE	CHANNEL ADDRESS PINS			CLOCK PIN	CHANNEL
AUTO	C3	C2	C1	MXCLK	
0	X	0	0	↑	0
0	X	0	1	↑	1
0	X	1	0	↑	2
0	X	1	1	↑	3

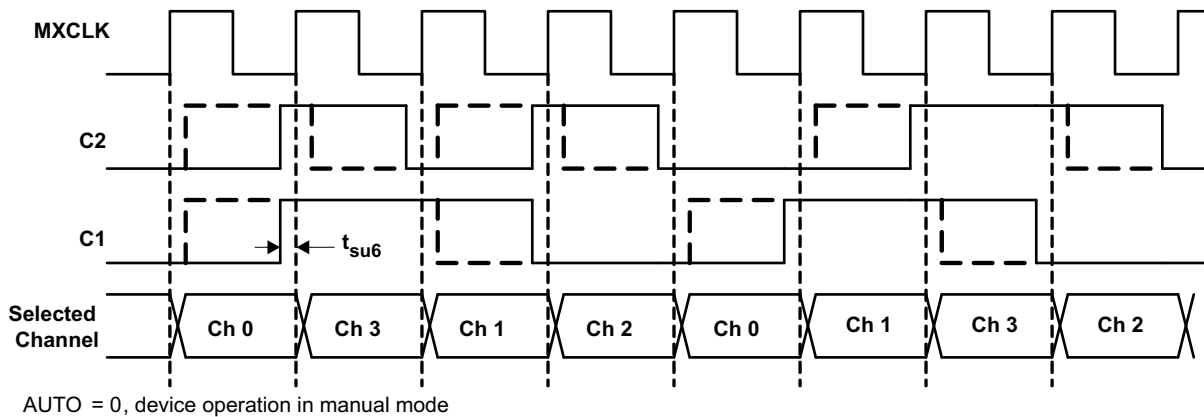

Figure 8. Multiplier Manual Mode Timing Diagram

6.10 Typical Characteristics

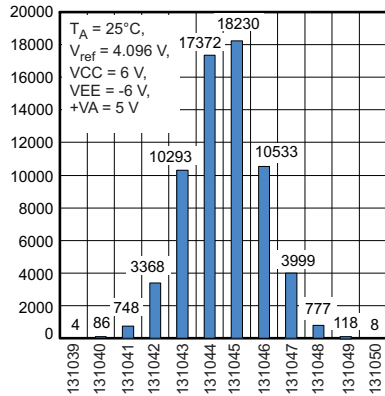

Figure 9. DC Histogram (CH0 without mux switching)

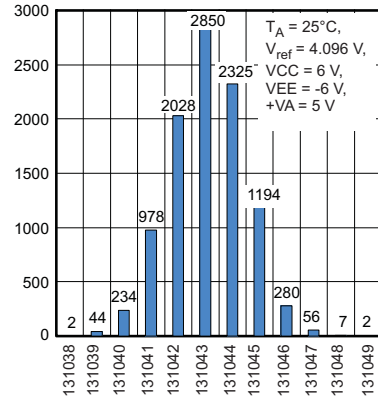

Figure 10. DC Histogram (CH0 with mux switching, CH 0-1-0)

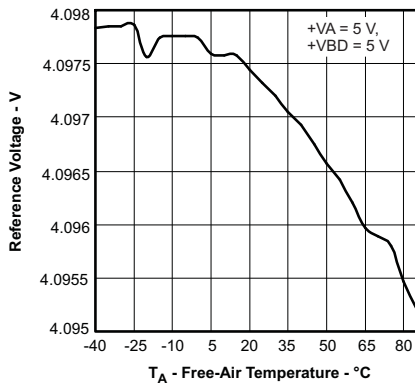

Figure 11. Internal Reference Voltage vs Free-air Temperature

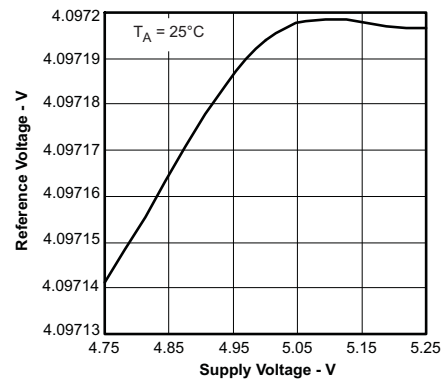

Figure 12. Internal Reference Voltage vs SI Voltage

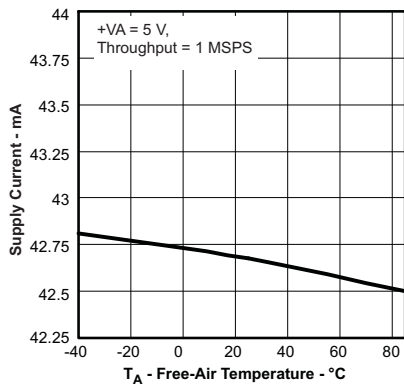

Figure 13. Analog Voltage (+VA) Supply Current (IA) vs Free-air Temperature

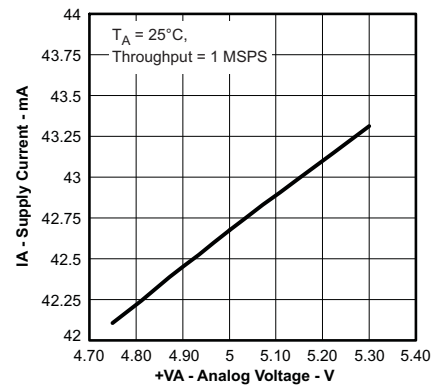

Figure 14. Supply Current (IA) vs Analog Voltage (+VA)

Typical Characteristics (continued)

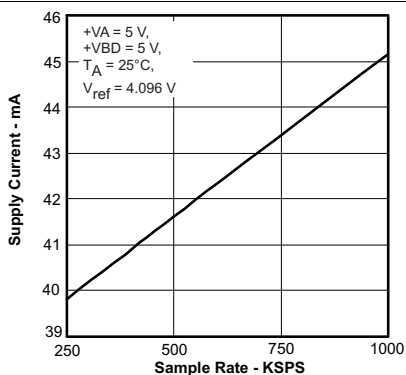

Figure 15. Analog Supply Current vs Sample Rate

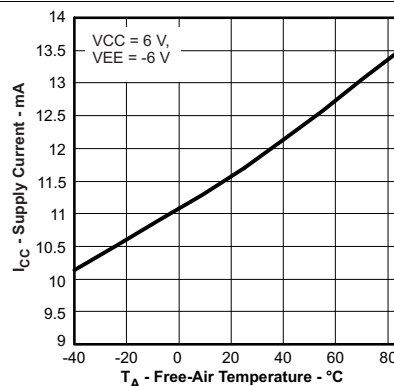

Figure 16. OPA Positive Supply Current ( $I_{CC}$ ) vs Free-air Temperature

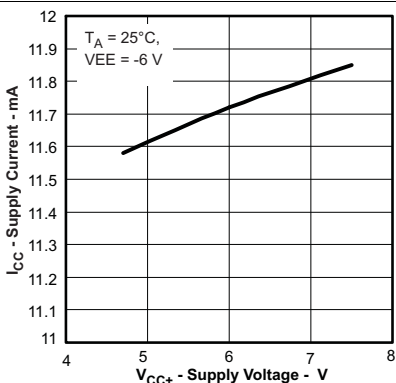

Figure 17. OPA Positive Supply Current ( $I_{CC}$ ) vs OPA Positive Supply Voltage (+VCC)

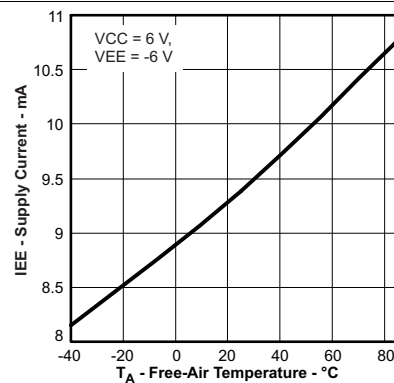

Figure 18. OPA -VE Supply Current ( $I_{EE}$ ) vs Free-air Temperature

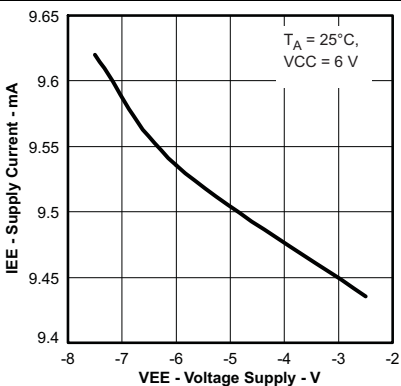

Figure 19. OPA Negative Supply Current ( $I_{EE}$ ) vs OPA Negative Supply Voltage (-VEE)

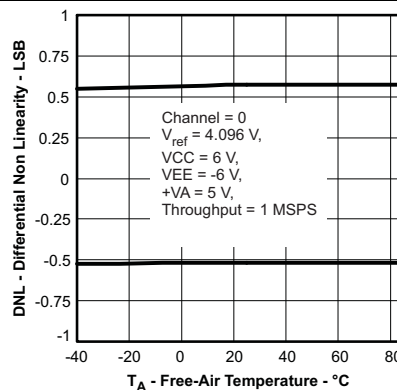

Figure 20. Differential Nonlinearity vs Free-air Temperature

Typical Characteristics (continued)

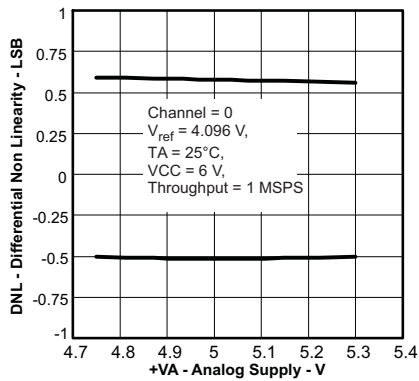

Figure 21. Differential Nonlinearity vs Analog Supply Voltage (+VA)

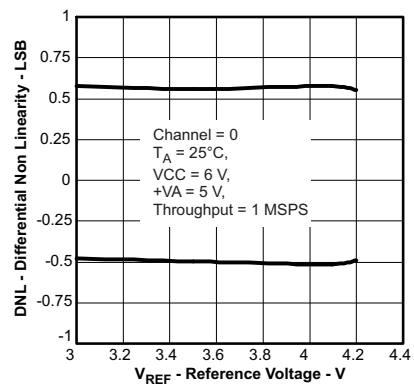

Figure 22. Differential Nonlinearity vs Reference Voltage

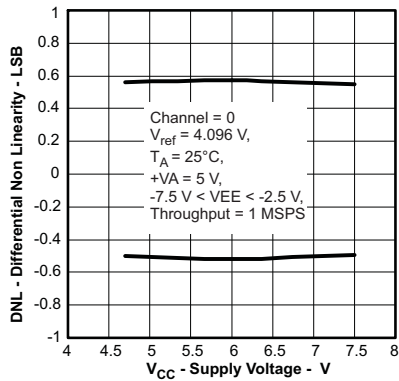

Figure 23. Differential Nonlinearity vs OPA Supply Voltage (VCC)

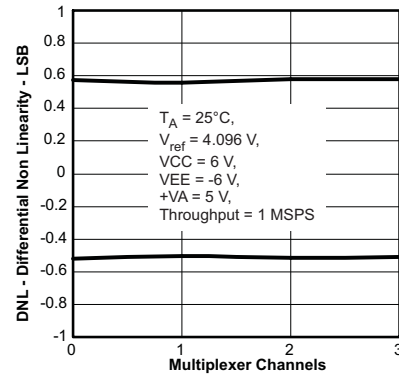

Figure 24. Differential Nonlinearity vs Multiplexer Channels

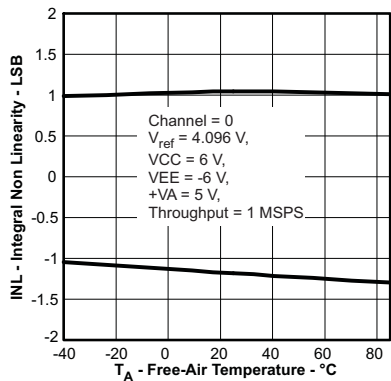

Figure 25. Integral Nonlinearity vs Free-air Temperature

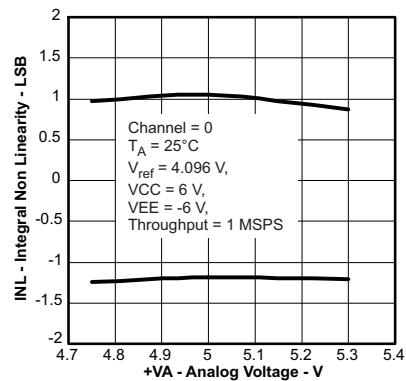

Figure 26. Integral Nonlinearity vs Analog Supply Voltage (+VA)

Typical Characteristics (continued)

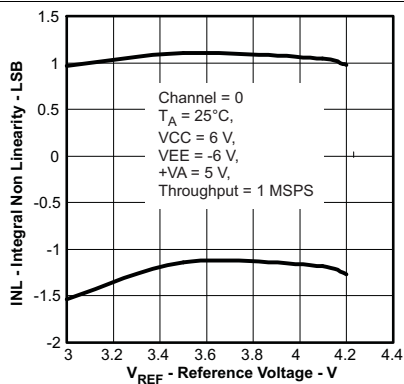

Figure 27. Integral Nonlinearity vs Reference Voltage

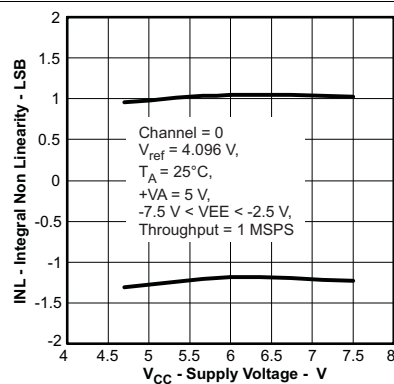

Figure 28. Integral Nonlinearity vs OPA Supply Voltage (+VCC)

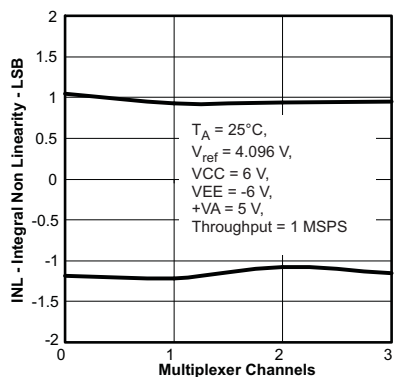

Figure 29. Integral Nonlinearity vs Multiplexer Channels

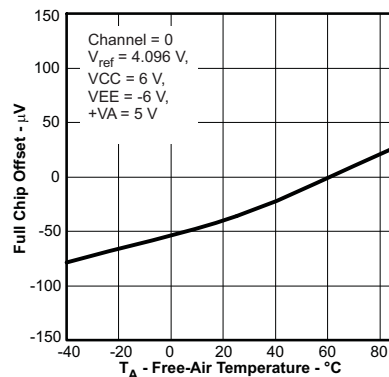

Figure 30. Full Chip Offset Error vs Free-air Temperature

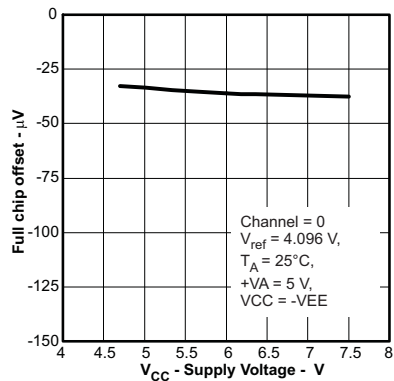

Figure 31. Full Chip Offset Error vs OPA Supply Voltage (VCC)

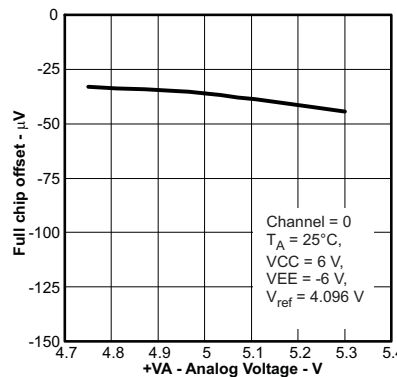

Figure 32. Full Chip Offset Error vs Analog Supply Voltage (+VA)

Typical Characteristics (continued)

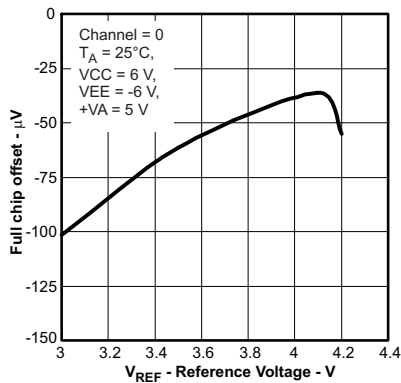

Figure 33. Full Chip Offset Error vs Reference Voltage

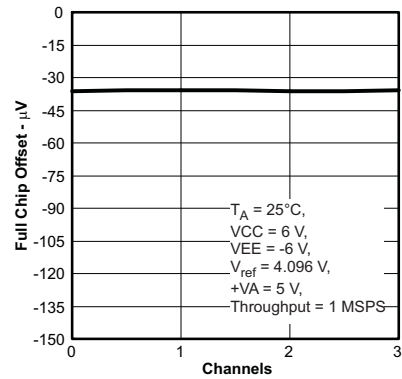

Figure 34. Full Chip Offset Error vs Channel

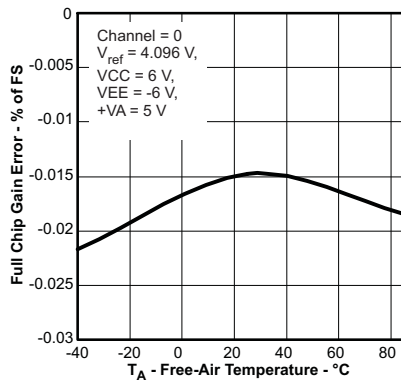

Figure 35. Full Chip Gain Error vs Free-air Temperature

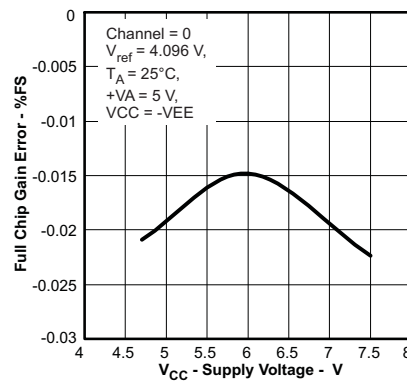

Figure 36. Full Chip Gain Error vs OPA Supply Voltage (VCC)

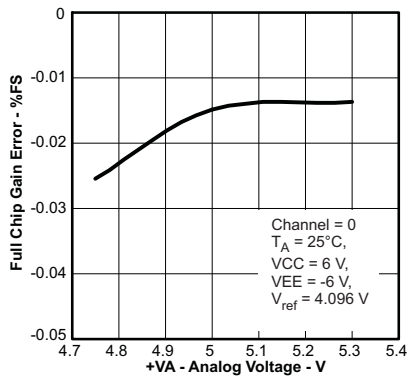

Figure 37. Full Chip Gain Error vs Analog Supply Voltage (+VA)

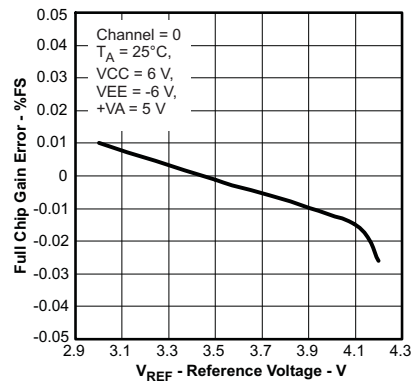

Figure 38. Full Chip Gain Error vs Reference Voltage

Typical Characteristics (continued)

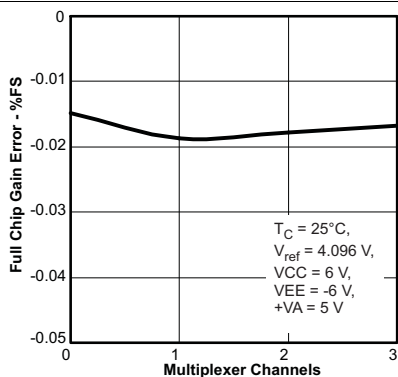

Figure 39. Full Chip Gain Error vs Multiplexer Channels

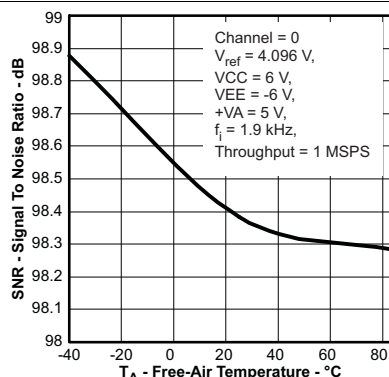

Figure 40. Signal-To-Noise Ratio vs Free-air Temperature

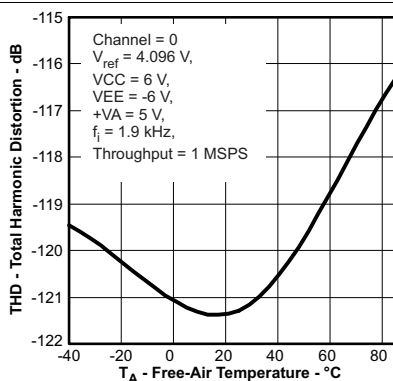

Figure 41. Total Harmonic Distortion vs Free-air Temperature

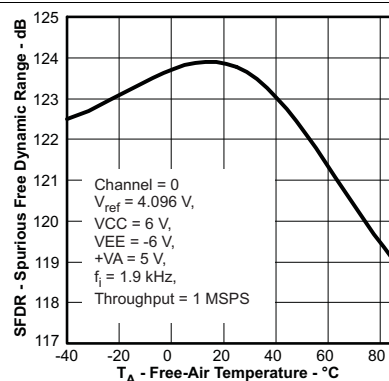

Figure 42. Spurious Free Dynamic Range vs Free-air Temperature

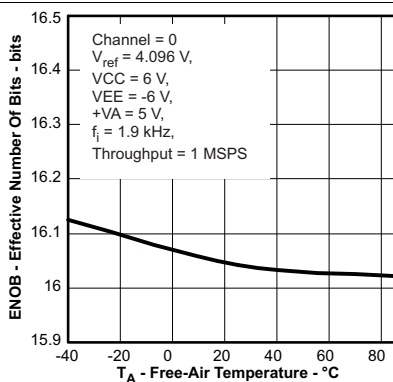

Figure 43. Effective Number Of Bits vs Free-air Temperature

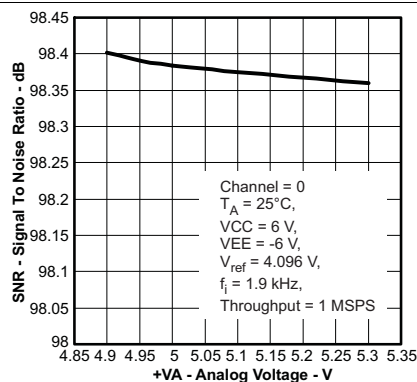

Figure 44. Signal-To-Noise Ratio vs Analog Supply Voltage (+VA)



Typical Characteristics (continued)

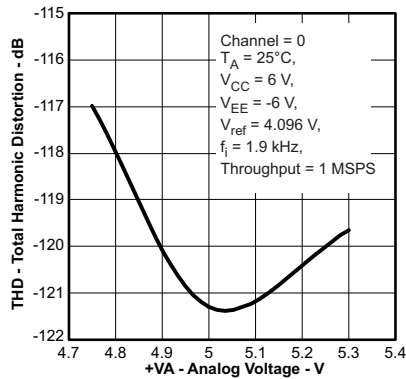

Figure 45. Total Harmonic Distortion vs Analog Supply Voltage (+VA)

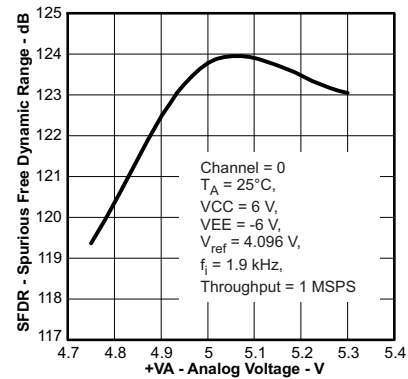

Figure 46. Spurious Free Dynamic Range vs Analog Supply Voltage (+VA)

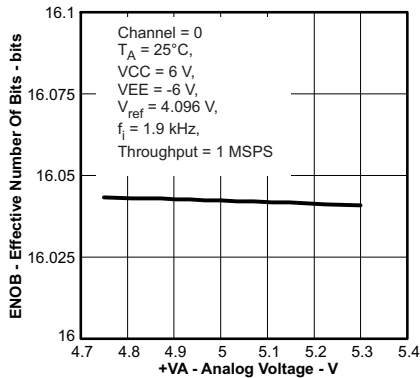

Figure 47. Effective Number Of Bits vs Analog Supply Voltage (+VA)

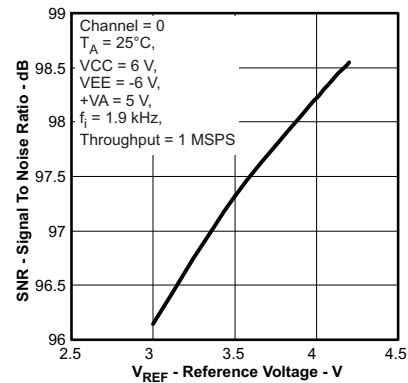

Figure 48. Signal-To-Noise Ratio vs Reference Voltage

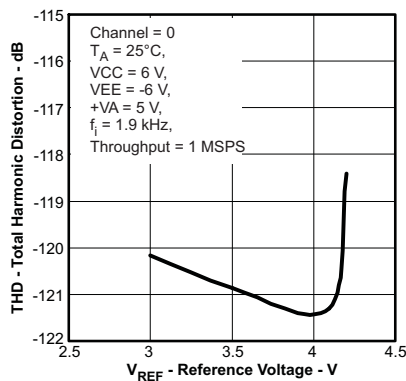

Figure 49. Total Harmonic Distortion vs Reference Voltage

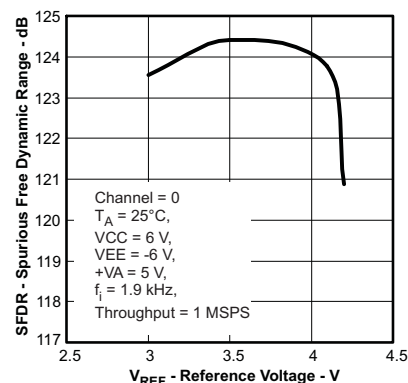

Figure 50. Spurious Free Dynamic Range vs Reference Voltage

Typical Characteristics (continued)

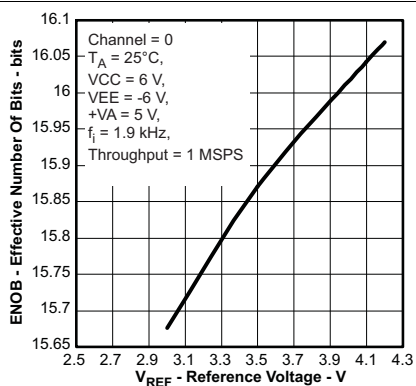

Figure 51. Effective Number Of Bits vs Reference Voltage

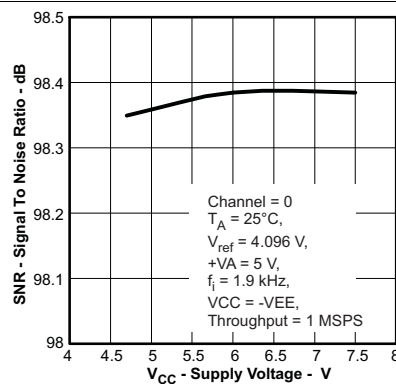

Figure 52. Signal-To-Noise Ratio vs OPA Supply Voltage (VCC)

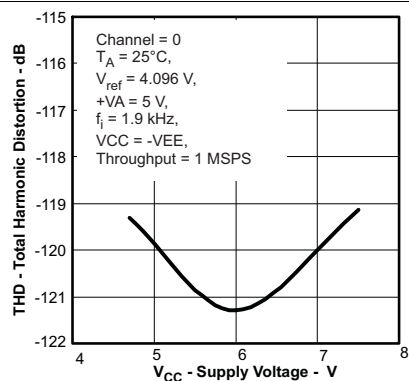

Figure 53. Total Harmonic Distortion vs OPA Supply Voltage (VCC)

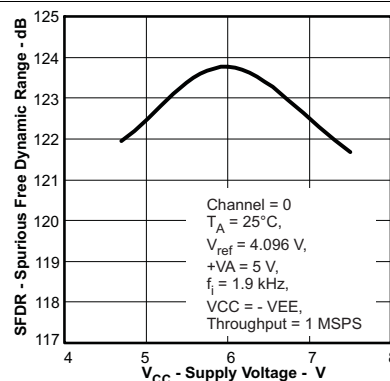

Figure 54. Spurious Free Dynamic Range vs OPA Supply Voltage (VCC)

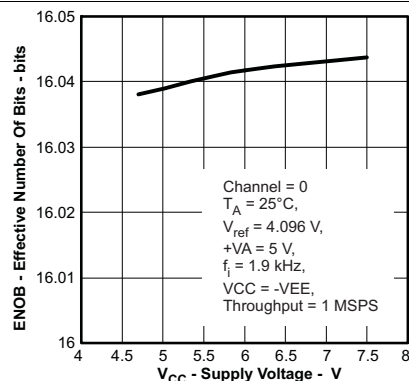

Figure 55. Effective Number Of Bits vs OPA Supply Voltage (VCC)

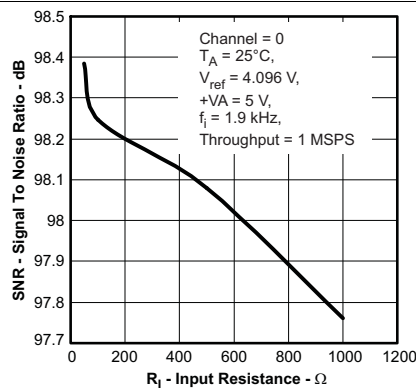

Figure 56. Signal-To-Noise Ratio vs Source Resistance (RIN)

Typical Characteristics (continued)

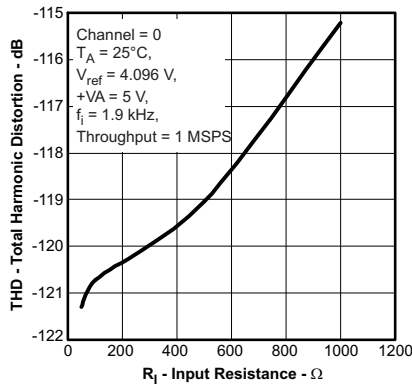

Figure 57. Total Harmonic Distortion vs Source Resistance (RIN)

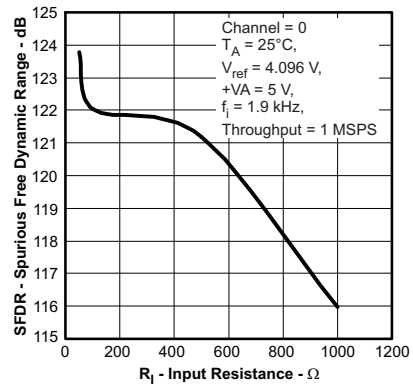

Figure 58. Spurious Free Dynamic Range vs Source Resistance (RIN)

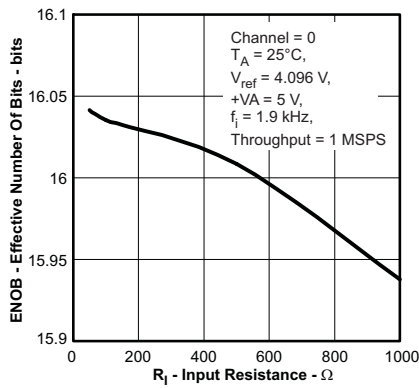

Figure 59. Effective Number OF Bits vs Source Resistance (RIN)

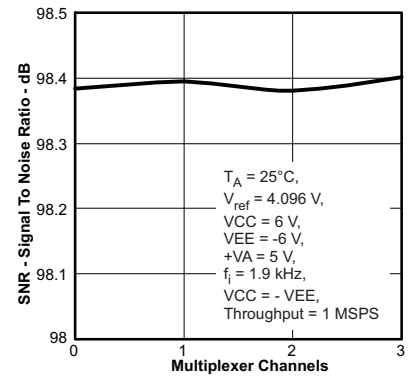

Figure 60. Signal-To-Noise Ratio vs Multiplexer Channels

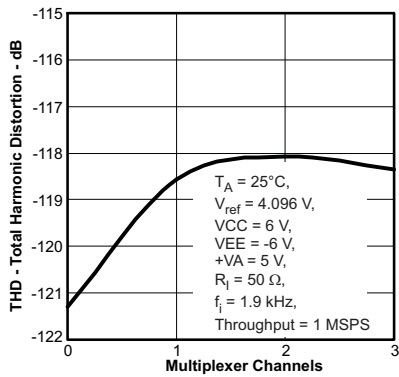

Figure 61. Total Harmonic Distortion vs Multiplexer Channels

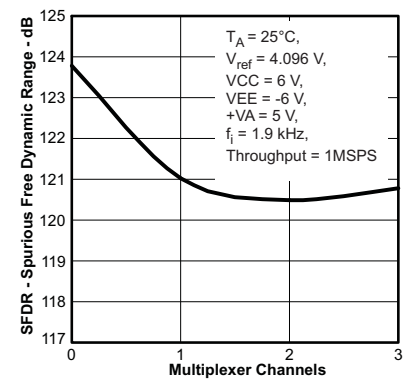

Figure 62. Spurious Free Dynamic Range vs Multiplexer Channels

Typical Characteristics (continued)

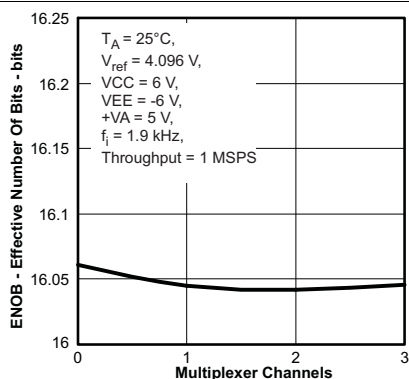

Figure 63. Effective Number Of Bits vs Multiplexer Channels

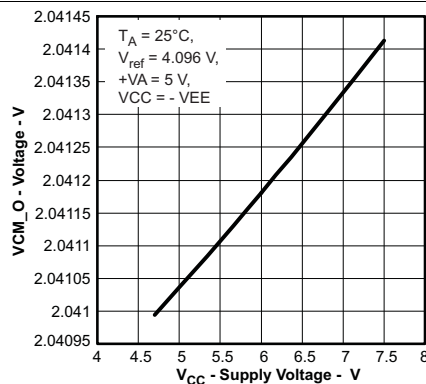

Figure 64. VCM\_O Voltage vs OPA Supply Voltage (VCC)

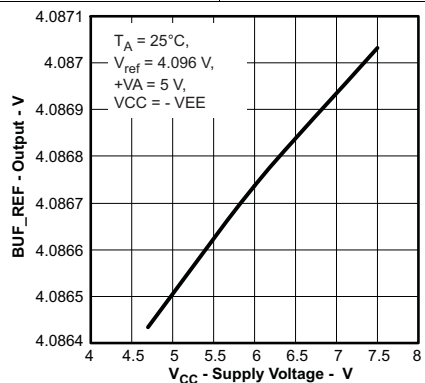
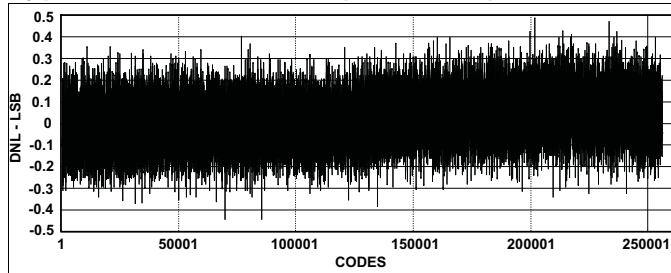

Figure 65. BUF\_REF Output Voltage vs OPA Supply Voltage (VCC)

**Typical Characteristics (continued)**



Test conditions: +VA = 5 V, +VBD = 5 V, T<sub>A</sub> =25°C, F<sub>s</sub> = 1 MSPS, V<sub>ref</sub> = 4.096 V

**Figure 66. TYPICAL DNL**

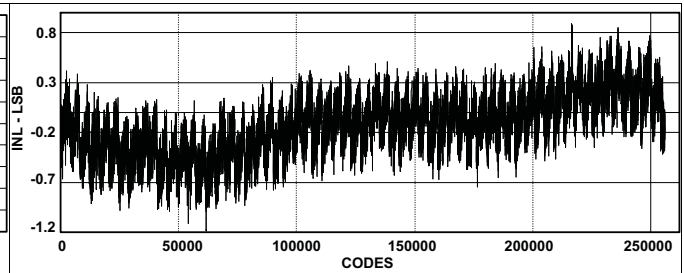

Test conditions: +VA = 5 V, +VBD = 5 V, T<sub>A</sub> =25°C, F<sub>s</sub> = 1 MSPS, V<sub>ref</sub> = 4.096 V

**Figure 67. TYPICAL INL**

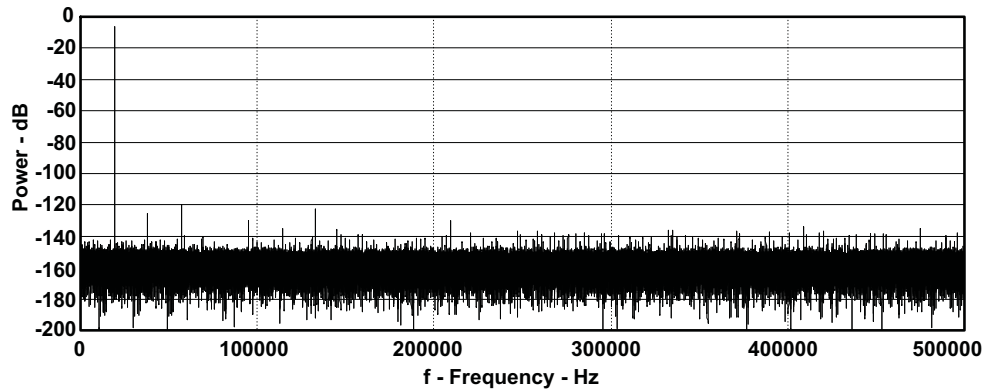

Test conditions: F<sub>i</sub> = 19 kHz, F<sub>s</sub> = 1 MSPS, V<sub>ref</sub> = 4.096V, SNR = 97.8 dB, THD = 113 dB, SFDR = 115 dB

**Figure 68. TYPICAL FFT**

## 7 Device Description

### 7.1 Overview

The ADS8284 features a high-speed successive approximation register (SAR) analog-to-digital converter (ADC). The architecture is based on charge redistribution which inherently includes a sample/hold function. See [Figure 73](#) for the application circuit for the ADS8284.

The conversion clock is generated internally. The conversion time of 650 ns is capable of sustaining a 1 MHz throughput.

The analog input voltage to ADC is provided to two input pins AINP and AINM. When a conversion is initiated, the differential input on these pins is sampled on the internal capacitor array. While a conversion is in progress, both inputs are disconnected from any internal function.

### 7.2 Functional Block Diagram

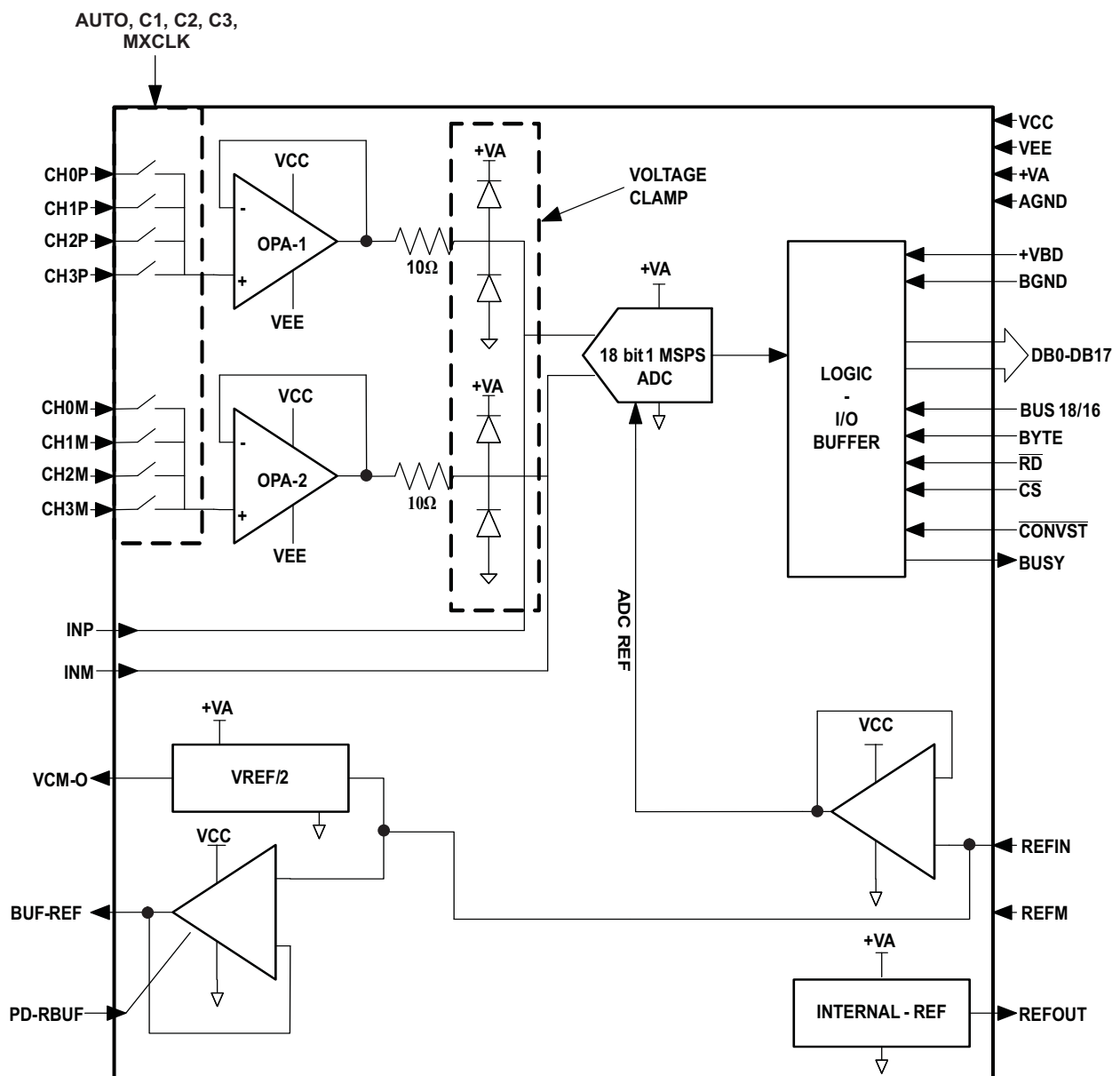

## 7.3 Feature Description

### 7.3.1 Analog Input

The device features an analog multiplexer, a differential, high input impedance, unity gain ADC driver, and a high performance ADC. Typically a lot of care is required for driving circuit component selection and board layout for high resolution ADC driving. However an on-board ADC driver simplifies the job for the user. All that is required is to decouple AINP and AINM with a 1-nF decoupling capacitor across these two pins as close to the device as possible. The multiplexer inputs tolerate source impedance of up to 50  $\Omega$  for specified device performance at an operating speed of 1-MSPS. This relaxes constraints on the signal conditioning circuit. In the case of true bipolar input signals, it is possible to condition them with a resistor divider as shown in [Figure 72](#). The device permits use of 1.2-k $\Omega$  resistors for the divider with effective source impedance of 600  $\Omega$  for signal bandwidth less than 10 kHz. A suitable capacitor value used to limit signal bandwidth limits noise coming from the resistor divider network. Care must be taken concerning absolute analog voltage at the multiplexer input pins. This voltage should not exceed VCC and VEE. The clamp at the driver OPA limits the voltage applied to the ADC input.

### 7.3.2 Reference

The ADS8284 can operate with an external reference with a range from 3.0 V to 4.2 V. The reference voltage on the input pin 10 (REFIN) of the converter is internally buffered. A clean, low noise, well-decoupled reference voltage on this pin is required to ensure good performance of the converter. A low noise band-gap reference like the REF5040 can be used to drive this pin. A 0.1- $\mu$ F decoupling capacitor is required between REFIN and REFM pins (pin 10 and pin 9) of the converter. This capacitor should be placed as close as possible to the pins of the device. Designers should strive to minimize the routing length of the traces that connect the pins of the capacitor to the pins of the converter. An RC network can also be used to filter the reference voltage. A 100- $\Omega$  series resistor and a 0.1- $\mu$ F capacitor, which can also serve as the decoupling capacitor can be used to filter the reference voltage.

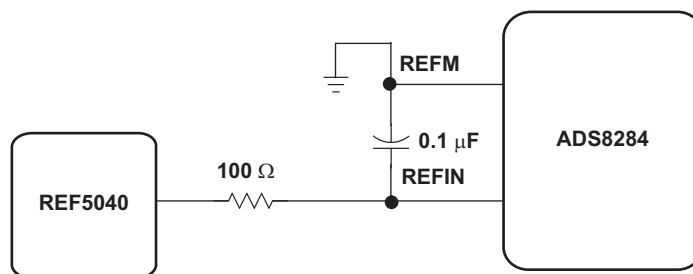

**Figure 69. ADS8284 Using External Reference**

The ADS8284 also has limited low pass filtering capability built into the converter. The equivalent circuitry on the REFIN input is as shown in [Figure 70](#).

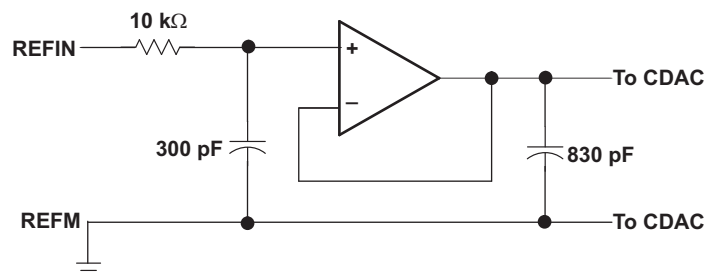

**Figure 70. Simplified Reference Input Circuit**

## Feature Description (continued)

The REFM input of the ADS8284 should always be shorted to AGND. A 4.096-V internal reference is included. When the internal reference is used, pin 11 (REFOUT) is connected to pin 10 (REFIN) with an 0.1- $\mu$ F decoupling capacitor and 1- $\mu$ F storage capacitor between pin 11 (REFOUT) and pin 9 (REFM) (see Figure 74). The internal reference of the converter is double buffered. If an external reference is used, the second buffer provides isolation between the external reference and the CDAC. This buffer is also used to recharge all of the capacitors of the CDAC during conversion (see Figure 70). pin 11 (REFOUT) can be left unconnected (floating) if external reference is used.

## 7.4 Device Functional Modes

### 7.4.1 Reading Data

The ADS8284 outputs full parallel data in straight binary format as shown in Table 3. The parallel output is active when  $\overline{CS}$  and  $\overline{RD}$  are both low. There is a minimal quiet zone requirement around the falling edge of  $\overline{CONVST}$ . This is 50 ns prior to the falling edge of  $\overline{CONVST}$  and 40 ns after the falling edge. No data read should attempted within this zone. Any other combination of  $\overline{CS}$  and  $\overline{RD}$  sets the parallel output to 3-state. BYTE and BUS18/16 are used for multiword read operations. BYTE is used whenever lower bits on the bus are output on the higher byte of the bus. BUS18/16 is used whenever the last two bits on the 18-bit bus is output on either bytes of the higher 16-bit bus. Refer to Table 3 for ideal output codes.

Table 3. Ideal Input Voltages and Output Codes

DESCRIPTION	ANALOG VALUE	DIGITAL OUTPUT STRAIGHT BINARY	
		BINARY CODY	HEX CODE
Full scale range	$2 \times (+V_{ref})$		
Least significant bit (LSB)	$2 \times (+V_{ref})/262144$		
+Full scale	$(+V_{ref}) - 1 \text{ LSB}$	01 1111 1111 1111 1111	1FFFF
Midscale	0 V	00 0000 0000 0000 0000	00000
Midscale – 1 LSB	$0 \text{ V} - 1 \text{ LSB}$	11 1111 1111 1111 1111	3FFFF
Zero	$-V_{ref}$	10 0000 0000 0000 0000	20000

The output data is a full 18-bit word (D17–D0) on DB17–DB0 pins (MSB–LSB) if both BUS18/16 and BYTE are low.

The result may also be read on an 16-bit bus by using only pins DB17–DB2. In this case two reads are necessary: the first as before, leaving both BUS18/16 and BYTE low and reading the 16 most significant bits (D17–D2) on pins DB17–DB2, then bringing BUS18/16 high while holding BYTE low. When BUS18/16 is high, the lower two bits (D1–D0) appear on pins DB3–DB2.

The result may also be read on an 8-bit bus for convenience. This is done by using only pins DB17–DB10. In this case three reads are necessary: the first as before, leaving both BUS18/16 and BYTE low and reading the 8 most significant bits on pins DB17–DB10, then bringing BYTE high while holding BUS18/16 low. When BYTE is high, the medium bits (D9–D2) appear on pins DB17–DB10. The last read is done by bringing BUS18/16 high while holding BYTE high. When BUS18/16 is high, the lower two bits (D1–D0) appear on pins DB11–DB10. The last read cycle is not necessary if only the first 16 most significant bits are of interest.

All of these multiword read operations can be performed with multiple active  $\overline{RD}$  (toggling) or with  $\overline{RD}$  held low for simplicity. This is referred to as the AUTO READ operation.

Table 4. Conversion Data Read Out

BYTE	BUS18/16	DATA READ OUT				
		TERMINAS DB17–DB12	TERMINAS DB11–DB10	TERMINAS DB9–DB4	TERMINAS DB3–DB2	TERMINAS DB1–DB0
High	High	All One's	D1–D0	All One's	All One's	All One's
Low	High	All One's	All One's	All One's	D1–D0	All One's
High	Low	D9–D4	D3–D2	All One's	All One's	All One's
Low	Low	D17–D12	D11–D10	D9–D4	D3–D2	D1–D0



## 8 Application and Implementation

### 8.1 Application Information

As discussed before, the ADS8284 is 18-bit analog SoC that includes various blocks like a multiplexer, ADC driver, internal reference, internal reference buffer, buffered reference output, and Ref/2 output on-board. The following diagram shows the recommended analog and digital interfacing of the ADS8284.

### 8.2 Typical Applications

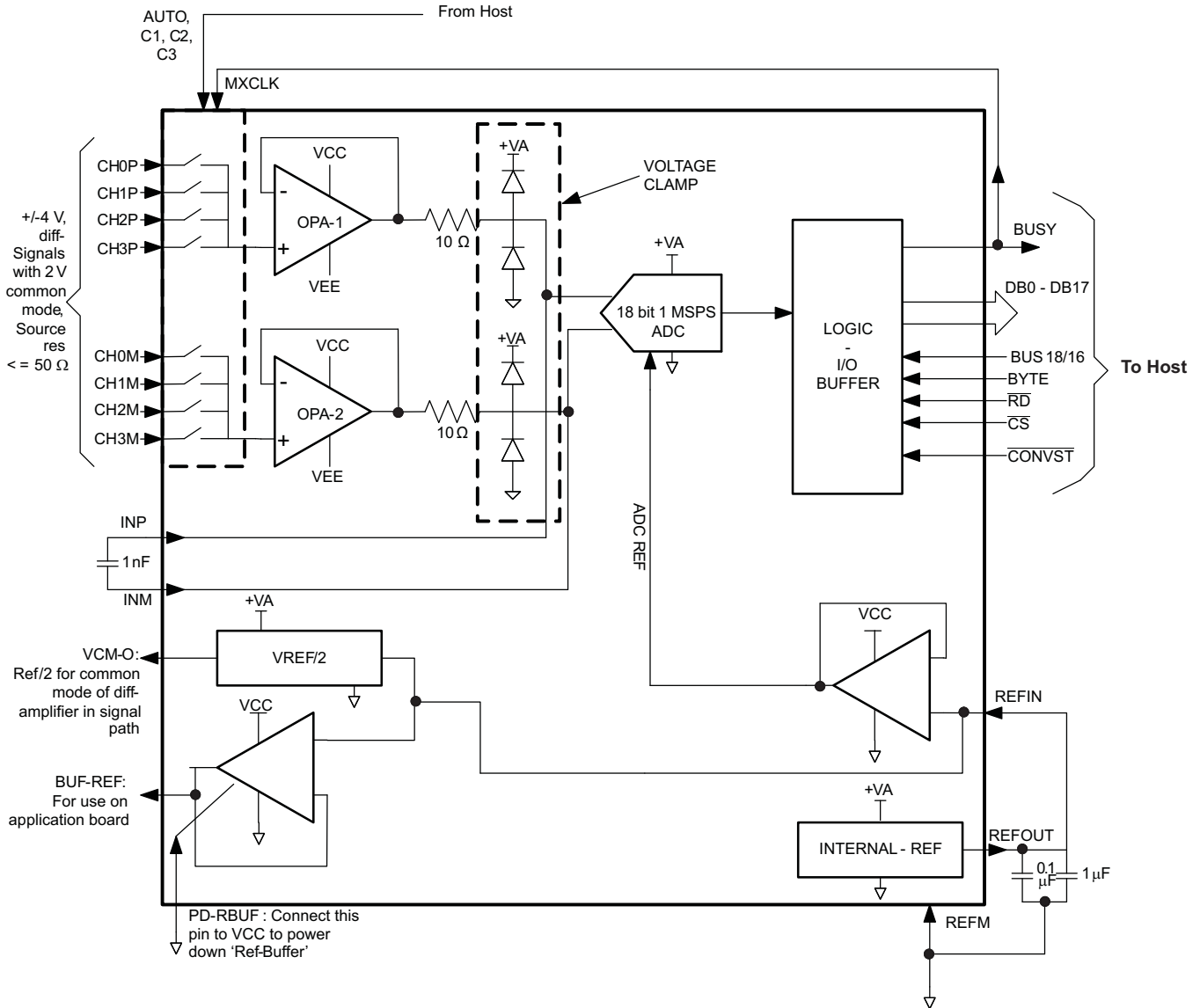

**Figure 71. Analog and Digital Interface Diagram**

### Typical Applications (continued)

As shown in Figure 71, the ADS8284 accepts unipolar differential analog inputs in the range of  $\pm V_{ref}$  with a common-mode voltage of  $V_{ref}/2$  (0 to  $V_{ref}$  at positive input and  $V_{ref}$  to 0 at negative input). An application may require the interfacing of true bipolar input signals. Figure 72 shows the conversion of bipolar input signals to unipolar differential signals.

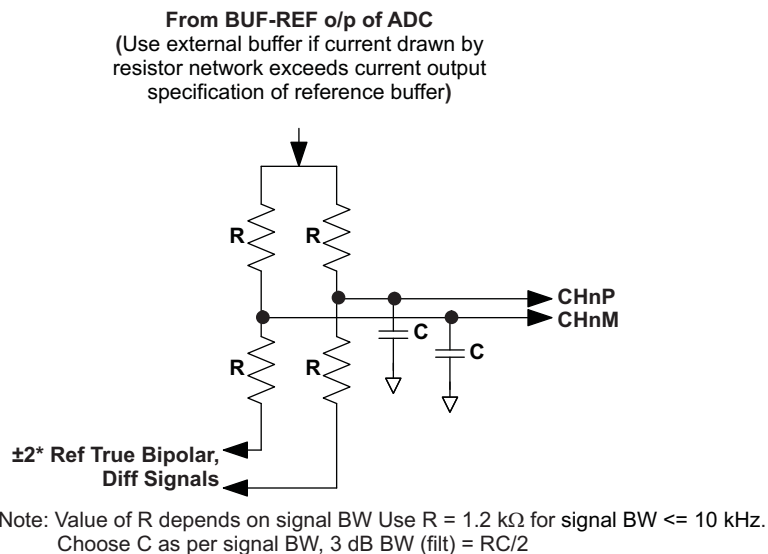

**Figure 72. Conversion of Bipolar Input Signals to Unipolar Differential Signals**

Typical Applications (continued)

Figure 73 shows a parallel interface between the ADS8284 and a typical microcontroller using an 8-bit data bus.

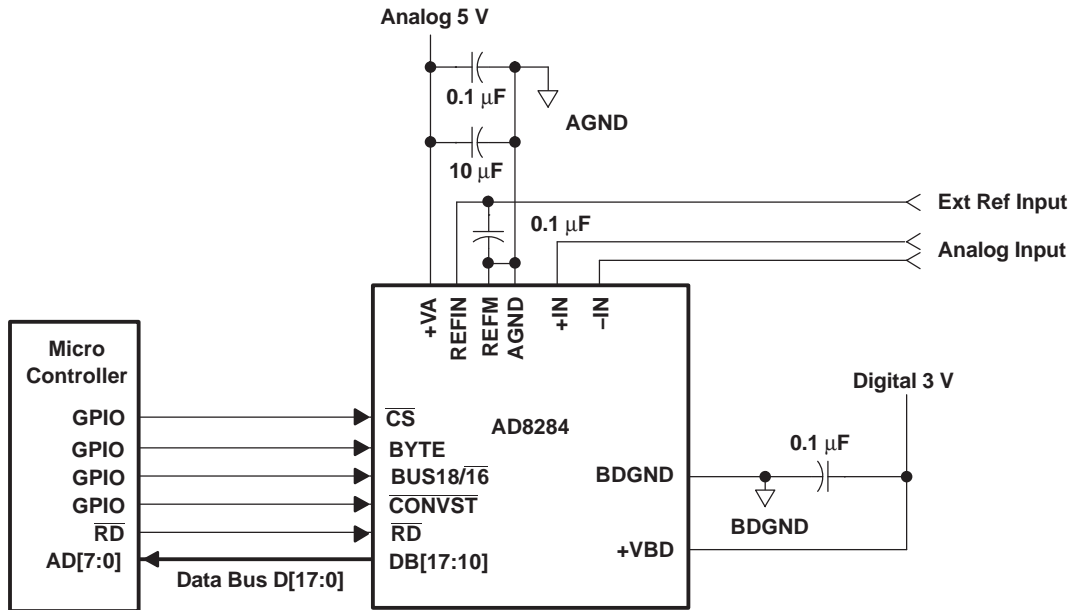

Figure 73. ADS8284 Application Circuitry

The BUSY signal is used as a falling edge interrupt to the microcontroller.

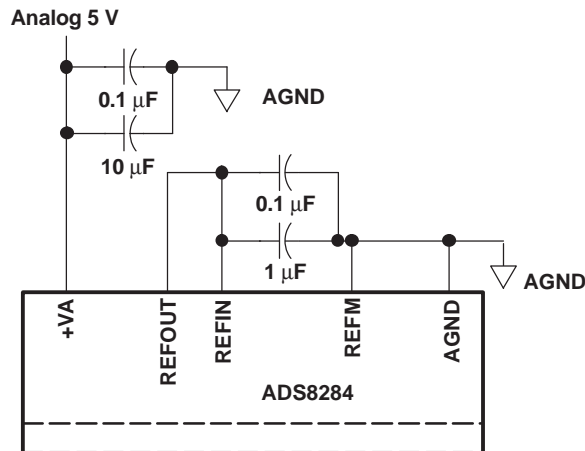

Figure 74. ADS8284 Using Internal Reference

## 9 Power Supply Recommendations

**Table 5. Power Recommendations**

Voltage Supply	MIN	TYP	MAX
VBD	2.7 V	3.3 V	5.25 V
VA	4.75 V	5 V	5.25 V
VCC	4.75 V	5 V	7.5 V
VEE	-7.5 V	-5 V	-3 V

## 10 Device and Documentation Support

### 10.1 Trademarks

All trademarks are the property of their respective owners.

### 10.2 Electrostatic Discharge Caution



These devices have limited built-in ESD protection. The leads should be shorted together or the device placed in conductive foam during storage or handling to prevent electrostatic damage to the MOS gates.

### 10.3 Glossary

[SLYZ022](#) — *TI Glossary*.

This glossary lists and explains terms, acronyms and definitions.

## 11 Mechanical, Packaging, and Orderable Information

The following pages include mechanical packaging and orderable information. This information is the most current data available for the designated devices. This data is subject to change without notice and revision of this document. For browser-based versions of this data sheet, refer to the left-hand navigation.

## PACKAGING INFORMATION

Orderable Device	Status (1)	Package Type	Package Drawing	Pins	Package Qty	Eco Plan (2)	Lead/Ball Finish (6)	MSL Peak Temp (3)	Op Temp (°C)	Device Marking (4/5)	Samples
ADS8284IBRGCR	NRND	VQFN	RGC	64	2000	Green (RoHS & no Sb/Br)	NIPDAU	Level-3-260C-168 HR	-40 to 85	ADS8284 B	
ADS8284IBRGCT	NRND	VQFN	RGC	64	250	Green (RoHS & no Sb/Br)	NIPDAU	Level-3-260C-168 HR	-40 to 85	ADS8284 B	
ADS8284IRGCR	NRND	VQFN	RGC	64	2000	Green (RoHS & no Sb/Br)	NIPDAU	Level-3-260C-168 HR	-40 to 85	ADS8284	
ADS8284IRGCT	NRND	VQFN	RGC	64	250	Green (RoHS & no Sb/Br)	NIPDAU	Level-3-260C-168 HR	-40 to 85	ADS8284	

(1) The marketing status values are defined as follows:

**ACTIVE:** Product device recommended for new designs.

**LIFEBUY:** TI has announced that the device will be discontinued, and a lifetime-buy period is in effect.

**NRND:** Not recommended for new designs. Device is in production to support existing customers, but TI does not recommend using this part in a new design.

**PREVIEW:** Device has been announced but is not in production. Samples may or may not be available.

**OBSELETE:** TI has discontinued the production of the device.

(2) **RoHS:** TI defines "RoHS" to mean semiconductor products that are compliant with the current EU RoHS requirements for all 10 RoHS substances, including the requirement that RoHS substance do not exceed 0.1% by weight in homogeneous materials. Where designed to be soldered at high temperatures, "RoHS" products are suitable for use in specified lead-free processes. TI may reference these types of products as "Pb-Free".

**RoHS Exempt:** TI defines "RoHS Exempt" to mean products that contain lead but are compliant with EU RoHS pursuant to a specific EU RoHS exemption.

**Green:** TI defines "Green" to mean the content of Chlorine (Cl) and Bromine (Br) based flame retardants meet JS709B low halogen requirements of  $\leq 1000$ ppm threshold. Antimony trioxide based flame retardants must also meet the  $\leq 1000$ ppm threshold requirement.

(3) MSL, Peak Temp. - The Moisture Sensitivity Level rating according to the JEDEC industry standard classifications, and peak solder temperature.

(4) There may be additional marking, which relates to the logo, the lot trace code information, or the environmental category on the device.

(5) Multiple Device Markings will be inside parentheses. Only one Device Marking contained in parentheses and separated by a "-" will appear on a device. If a line is indented then it is a continuation of the previous line and the two combined represent the entire Device Marking for that device.

(6) Lead/Ball Finish - Orderable Devices may have multiple material finish options. Finish options are separated by a vertical ruled line. Lead/Ball Finish values may wrap to two lines if the finish value exceeds the maximum column width.

**Important Information and Disclaimer:** The information provided on this page represents TI's knowledge and belief as of the date that it is provided. TI bases its knowledge and belief on information provided by third parties, and makes no representation or warranty as to the accuracy of such information. Efforts are underway to better integrate information from third parties. TI has taken and

continues to take reasonable steps to provide representative and accurate information but may not have conducted destructive testing or chemical analysis on incoming materials and chemicals. TI and TI suppliers consider certain information to be proprietary, and thus CAS numbers and other limited information may not be available for release.

In no event shall TI's liability arising out of such information exceed the total purchase price of the TI part(s) at issue in this document sold by TI to Customer on an annual basis.

**TAPE AND REEL INFORMATION**

**QUADRANT ASSIGNMENTS FOR PIN 1 ORIENTATION IN TAPE**

\*All dimensions are nominal

Device	Package Type	Package Drawing	Pins	SPQ	Reel Diameter (mm)	Reel Width W1 (mm)	A0 (mm)	B0 (mm)	K0 (mm)	P1 (mm)	W (mm)	Pin1 Quadrant
ADS8284IBRGCR	VQFN	RGC	64	2000	330.0	16.4	9.3	9.3	1.5	12.0	16.0	Q2
ADS8284IBRGCT	VQFN	RGC	64	250	180.0	16.4	9.3	9.3	1.5	12.0	16.0	Q2
ADS8284IRGCR	VQFN	RGC	64	2000	330.0	16.4	9.3	9.3	1.5	12.0	16.0	Q2
ADS8284IRGCT	VQFN	RGC	64	250	180.0	16.4	9.3	9.3	1.5	12.0	16.0	Q2



**TAPE AND REEL BOX DIMENSIONS**

\*All dimensions are nominal

Device	Package Type	Package Drawing	Pins	SPQ	Length (mm)	Width (mm)	Height (mm)
ADS8284IBRGCR	VQFN	RGC	64	2000	350.0	350.0	43.0
ADS8284IBRGCT	VQFN	RGC	64	250	213.0	191.0	55.0
ADS8284IRGCR	VQFN	RGC	64	2000	350.0	350.0	43.0
ADS8284IRGCT	VQFN	RGC	64	250	213.0	191.0	55.0

## GENERIC PACKAGE VIEW

**RGC 64**

**VQFN - 1 mm max height**

9 x 9, 0.5 mm pitch

PLASTIC QUAD FLATPACK - NO LEAD

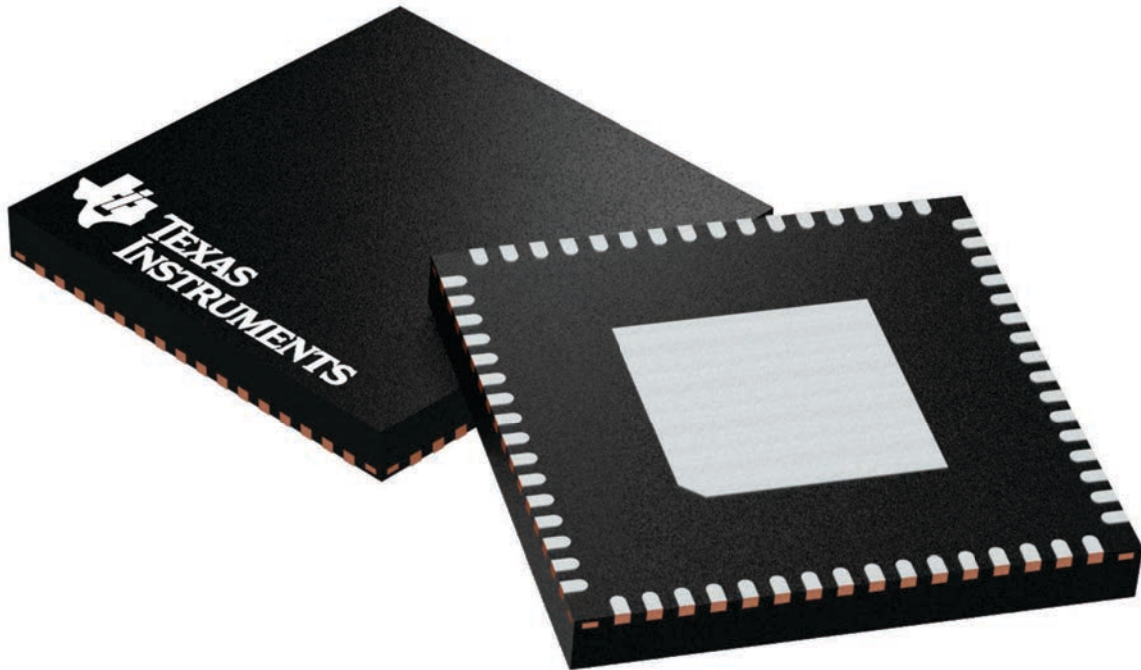

Images above are just a representation of the package family, actual package may vary.  
Refer to the product data sheet for package details.

4224597/A





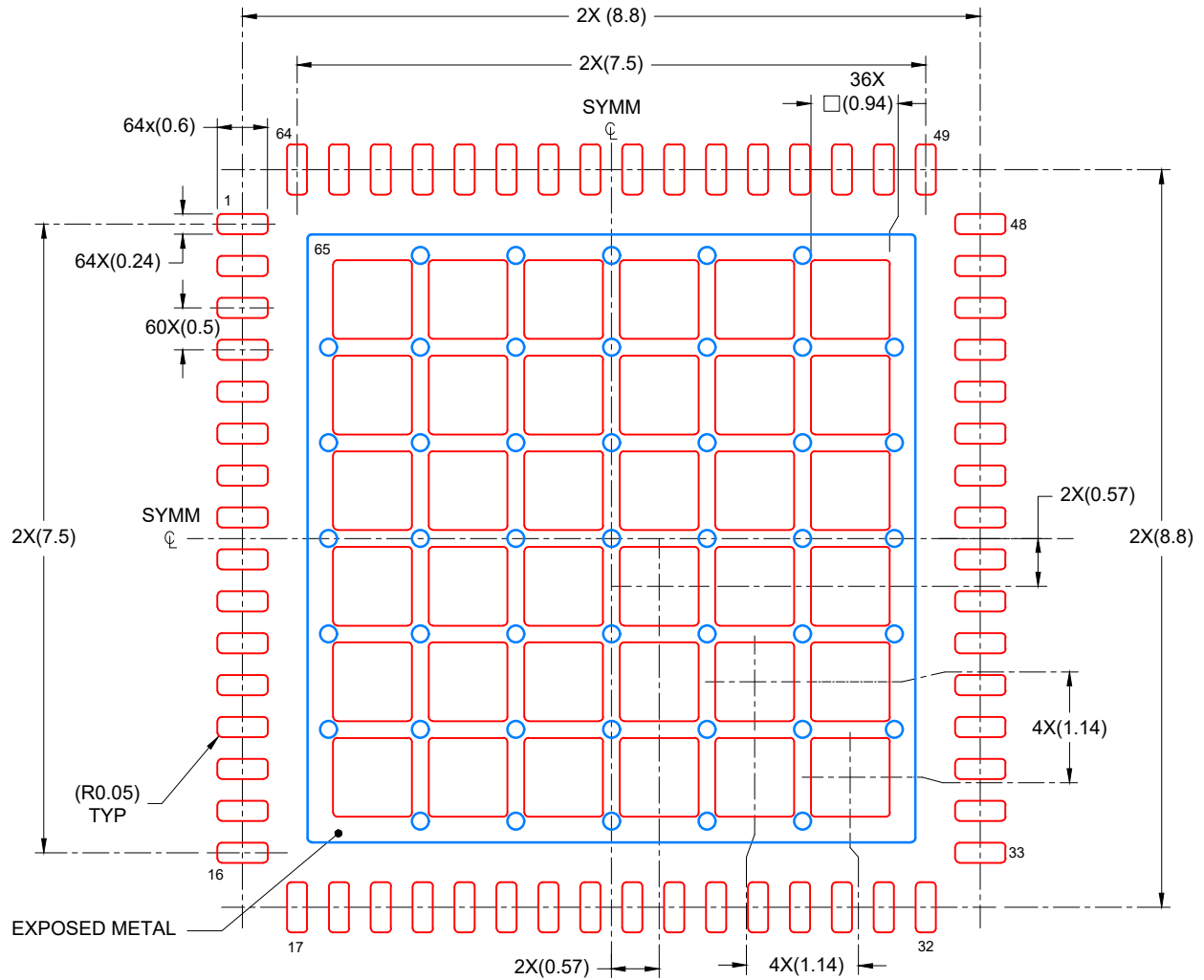

SOLDER PASTE EXAMPLE  
 BASED ON 0.125 mm THICK STENCIL

EXPOSED PAD  
 60% PRINTED COVERAGE BY AREA  
 SCALE: 12X

4219009/A 10/2018

NOTES: (continued)

6. Laser cutting apertures with trapezoidal walls and rounded corners may offer better paste release. IPC-7525 may have alternate design recommendations.

## IMPORTANT NOTICE AND DISCLAIMER

TI PROVIDES TECHNICAL AND RELIABILITY DATA (INCLUDING DATASHEETS), DESIGN RESOURCES (INCLUDING REFERENCE DESIGNS), APPLICATION OR OTHER DESIGN ADVICE, WEB TOOLS, SAFETY INFORMATION, AND OTHER RESOURCES "AS IS" AND WITH ALL FAULTS, AND DISCLAIMS ALL WARRANTIES, EXPRESS AND IMPLIED, INCLUDING WITHOUT LIMITATION ANY IMPLIED WARRANTIES OF MERCHANTABILITY, FITNESS FOR A PARTICULAR PURPOSE OR NON-INFRINGEMENT OF THIRD PARTY INTELLECTUAL PROPERTY RIGHTS.

These resources are intended for skilled developers designing with TI products. You are solely responsible for (1) selecting the appropriate TI products for your application, (2) designing, validating and testing your application, and (3) ensuring your application meets applicable standards, and any other safety, security, or other requirements. These resources are subject to change without notice. TI grants you permission to use these resources only for development of an application that uses the TI products described in the resource. Other reproduction and display of these resources is prohibited. No license is granted to any other TI intellectual property right or to any third party intellectual property right. TI disclaims responsibility for, and you will fully indemnify TI and its representatives against, any claims, damages, costs, losses, and liabilities arising out of your use of these resources.

TI's products are provided subject to TI's Terms of Sale ([www.ti.com/legal/termsofsale.html](http://www.ti.com/legal/termsofsale.html)) or other applicable terms available either on [ti.com](http://ti.com) or provided in conjunction with such TI products. TI's provision of these resources does not expand or otherwise alter TI's applicable warranties or warranty disclaimers for TI products.

Mailing Address: Texas Instruments, Post Office Box 655303, Dallas, Texas 75265  
Copyright © 2020, Texas Instruments Incorporated