

REV.	ECN NO.	DESCRIPTION	SIGN	DATE
C1	N/A	INITIAL DRAWING	Liu	2020/05/13

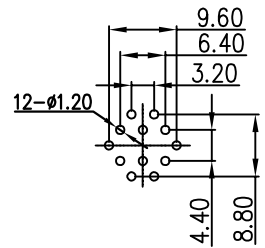

12 Pin
PCB Layout

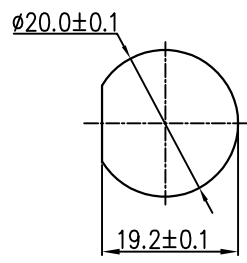

Recommended Panel Cut-Out

23XXX535-02
Pin Number

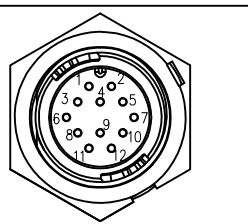

12 Pin

P/N: 23012535-02

Pin Assignments
Front View

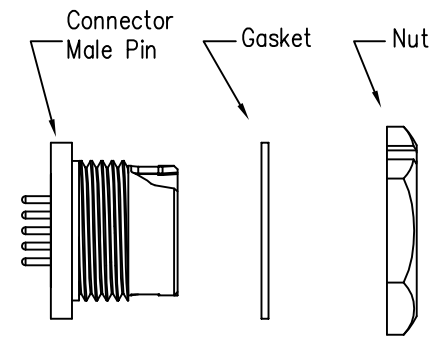
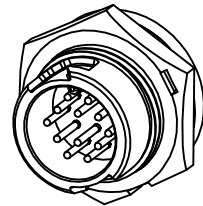
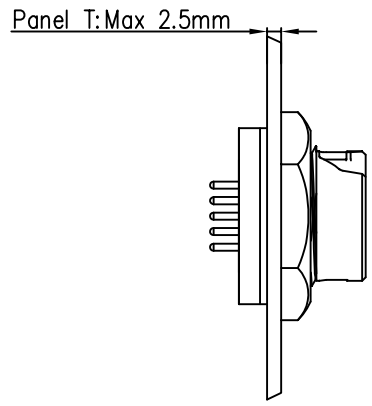
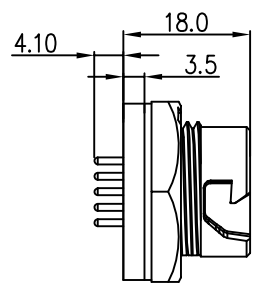

- Specification:
- 1.Operation Temperature: -45°C~105°C.
 - 2.Insulation Resistance:100MΩ at DC500V.
 - 3.Contact Resistance:<10mΩ.
 - 4.Withstand Voltage: 1000V AC
 - 5.Operating Current:5A
 - 6.Operating Voltage:DC 30V
 - 7.Waterproof Rate:IP67 (Mated)
 - 8.Housing:Nylon, Black
 - 9.Male Pin:Copper Alloy, Gold Plated
 - 10.Gasket:Silicon Gray
 - 11.Panel Nut:Nylon, Orange
 - 12.Torque Rate:0.8~1.0N·m
 - 13.RoHS Compliant.
 - 14.Mating Cap P/N:806-00047-00

UNIT:mm	
TOLERANCE	
.X	±0.25
.XX	±0.15
.XXX	±0.05
ANGLES	±1°

DESCRIPTION	Middle Series Push Lock Front Mount With Male Pin		
SCALE	1:1	SHEET	1 OF 1
REV.	C1	SIZE	A4
			* :Inspection Item



PART NO	23012535-02	DRAWN BY	Liu	DATE	2020/05/17
DWG NO		CHECKED BY	Mo	DATE	2020/05/17
CUSTOMER		APPROVED BY	Adley	DATE	2020/05/17

THIS INFORMATION IS CONFIDENTIAL AND IS DISCLOSED TO YOU ON CONDITION THAT NO FURTHER DISCLOSURE IS MADE BY YOU TO OTHER THAN CHOGORI PERSONNEL WITHOUT AUTHORIZATION FROM CHOGORI CORP.