

MAXM17625/MAXM17626 Evaluation Kits

Evaluate: MAXM17625/MAXM17626 Modules in Application

General Description

The MAXM17625/MAXM17626 evaluation kits (EV kits) provide a proven design to evaluate the performance of the MAXM17625/MAXM17626 modules. Each of these modules are configured to demonstrate optimum performance and component sizes in the EV kits.

The MAXM17625 module delivers up to 600mA at a switching frequency of 2MHz. The module is configured for a 1.5V output over a 2.7V to 5.5V input range.

The MAXM17626 module delivers up to 600mA at a switching frequency of 4MHz. The module is configured for a 3.3V output over a 3.6V to 5.5V input range.

The EV kits feature provisions for selecting Mode of operation (PWM/PFM) and Enable input. The MAXM17625/MAXM17626 module data sheet provides a complete description of the parts that should be read in conjunction with this data sheet prior to operating the EV kits.

Features

- Operates up to 5.5V Input Supply
- MAXM17625 Offers High 92% Efficiency ($V_{IN} = 3.3V$, $V_{OUT} = 1.5V$, $I_{OUT} = 300\text{ mA}$)
- MAXM17626 Offers High 94.5% Efficiency ($V_{IN} = 5V$, $V_{OUT} = 3.3V$, $I_{OUT} = 400\text{ mA}$)
- Up to 600mA Load Current
- 2MHz Fixed Switching Frequency for the MAXM17625
- 4MHz Fixed Switching Frequency for the MAXM17626
- Selectable Pulse-Width Modulation (PWM) and Pulse-Frequency Modulation (PFM) Modes of Operation
- Internal 1ms Soft-Start Time
- Power-Good (PGOOD) Output with Pullup Resistor to Respective Input Voltages
- Low-Profile, Surface-Mount Components
- Proven PCB Layout
- Fully Assembled and Tested

[Ordering Information](#) at end of data sheet.

EV Kit Top View

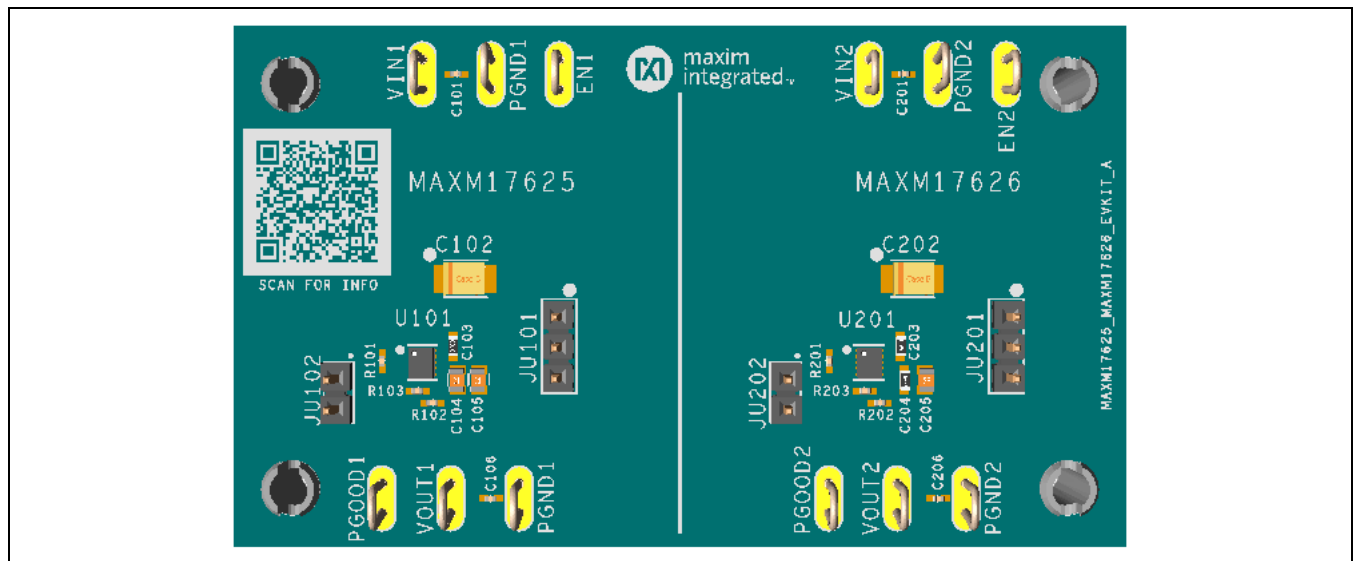

Quick Start

Configuration Diagram

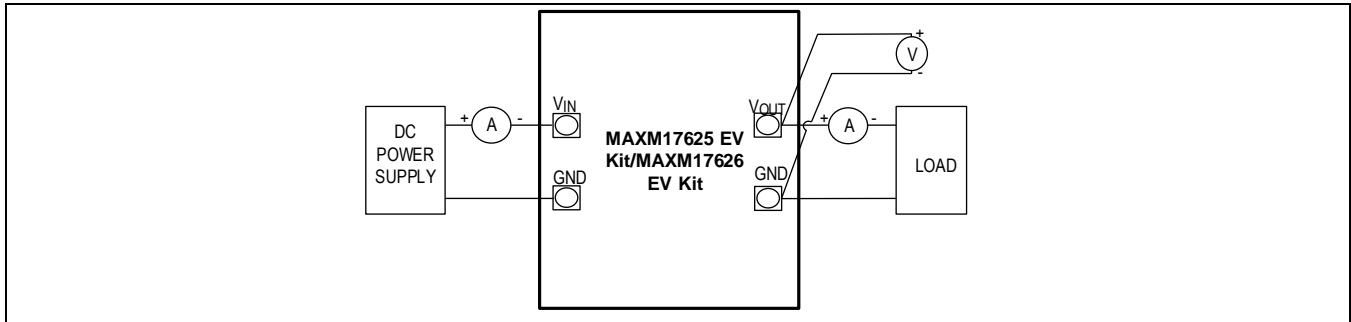

MAXM17625/MAXM17626 EV Kits Setup Diagram

Required Equipment

- One 2.7V to 5.5V DC, 600mA power supply.
- Load resistors capable of sinking up to 600mA at 1.5V and 3.3V (2.5Ω for the MAXM17625 and 5.5Ω for the MAXM17626)
- Digital multimeter (DMM)

Procedure

The EV kits are fully assembled and tested. Follow the steps below to verify and test individual modules operation.

Caution: Do not turn on power supply until all connections are completed.

1. Disable the power supply and set the input power supply at a valid input voltage.
2. Connect the positive terminal and negative terminal of the power supply to the VIN pad and its adjacent PGND pad of the module under evaluation.
3. Connect a 600mA (max) resistive load across the VOUT pad and its nearest PGND pad of the corresponding module.
4. Verify that shunts are installed in default position on jumpers, JU101 for the MAXM17625 and JU201 for the MAXM17626 (see [Table 1](#) for details).
5. Select the shunt position on jumpers, JU102 for the MAXM17625 and JU202 for the MAXM17626 according to the required mode of operation (see [Table 2](#) for details).
6. Connect the digital multimeter in voltage measurement mode across the VOUT and its respective PGND pad.
7. Turn on the input power supply.
8. Verify that the digital multimeter displays expected terminal voltage with respect to PGND.

Detailed Description

The MAXM17625/MAXM17626 EV kits are designed to demonstrate the salient features of the MAXM17625/MAXM17626 power modules. The EV kits consist of typical application circuits of two different modules. Each of these circuits are electrically isolated from each other and hosted on the same printed circuit board (PCB). Each of these circuits can be evaluated for its performance under different operating conditions by powering them from their respective input pins.

MODE Selection

The MAXM17625/MAXM17626 supports PWM and PFM modes of operation. In the EV kits, leave the jumpers JU102 for the MAXM17625 and JU202 for the MAXM17626 open for operating the modules in PFM mode at light load. Install shunts to configure the modules in PWM mode. See [Table 2](#) for jumper settings. Refer to Mode Selection section of the MAXM17625/MAXM17626 data sheet for more details.

Adjusting Output Voltage

- The MAXM17625 supports a 0.8V to 1.5V adjustable output voltage, and the MAXM17625 EV kit output voltage is preset to 1.5V.
- The MAXM17626 supports a 1.5V to 3.3V adjustable output voltage, and the MAXM17626 EV kit output voltage is preset to 3.3V.
- For the MAXM17625, the output voltage is programmed using the resistor divider R102 and R103, and for the MAXM17626, the output voltage is programmed using the resistor divider R202 and R203. Refer to the Adjusting Output Voltage section in the MAXM17625/MAXM17626 data sheet for more details.

Output Capacitor Selection

The X7R ceramic capacitors are preferred due to their stability over temperature in industrial applications. For the MAXM17625, the required output capacitor (C104) is 22 μ F/6.3V, and for the MAXM17626, the required output capacitor (C204) is 10 μ F/10V. Refer to *Output Capacitor Selection* section in the MAXM17625/MAXM17626 data sheet for more details.

Input Capacitor Selection

The input capacitors C103 for the MAXM17625 and C203 for the MAXM17626 serve to reduce the current peaks drawn from the input power supply and reduce switching frequency ripple at the input. Refer to the *Input Capacitor Selection* section in the MAXM17625/MAXM17626 data sheet to choose input capacitance. A 2.2 μ F/10V input capacitor is chosen for both the MAXM17625 and MAXM17626.

Hot Plug-In and Long Input Cables

The MAXM17625/MAXM17626 EV kit PCB provides optional tantalum capacitors (C102 for the MAXM17625 and C202 for the MAXM17626, 47 μ F/8V) to dampen input voltage peaks and oscillations that can arise during the hot plug-in and/or due to long input cables. These capacitors limit the peak voltage at the input of the device when the EV kits are powered directly from a precharged capacitive source or an industrial backplane PCB. Long input cables between the input power source and the EV kits circuit can cause input-voltage oscillations due to the inductance of the cables. The equivalent series resistance (ESR) of the tantalum capacitor helps damp out the oscillations caused by long input cables. Further, capacitors (C101 for the MAXM17625 and C201 for the MAXM17626, 0.1 μ F/10V) placed near the input of the board helps in attenuating high-frequency noise.

Table 1. EN Jumper Description (JU101, JU201)

SHUNT POSITION	EN PIN	OUTPUT
1-2*	Connected to V_{IN}	Enabled
2-3	Connected to GND	Disabled

**Default Position*

Table 2. MODE Jumper Description (JU102, JU202)

SHUNT POSITION	MODE PIN	OUTPUT
1-2	Connected to GND	Operates in PWM Mode in all load conditions
Not Installed*	Unconnected	Operates in PFM Mode in light load conditions

**Default Position*

MAXM17625/MAXM17626 EV Kits Performance Report

($V_{IN} = V_{EN} = 5V$, $V_{SGND} = V_{PGND} = 0V$, LX = Open, $T_A = -40^{\circ}C$ to $+125^{\circ}C$, unless otherwise noted. Typical values are at $T_A = +25^{\circ}C$. All voltages are referenced to SGND, unless otherwise noted.)

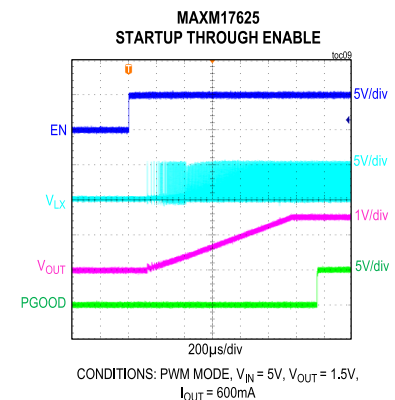
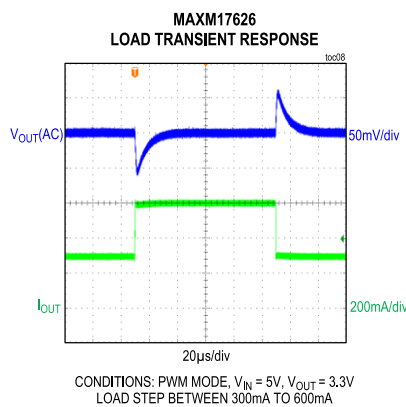
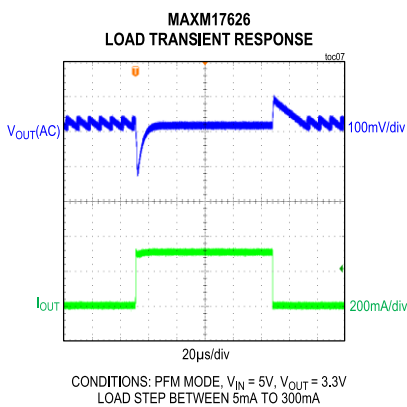
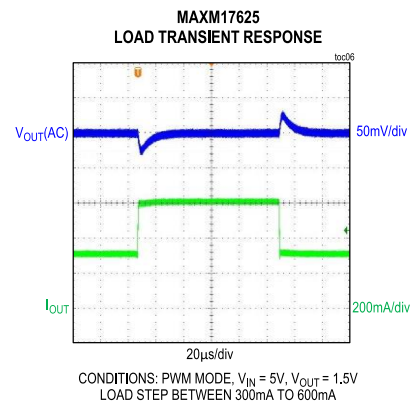
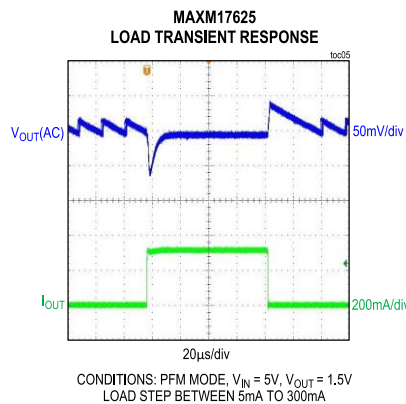
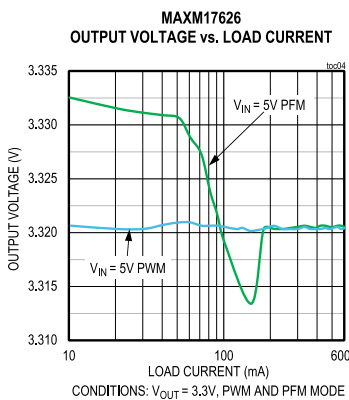
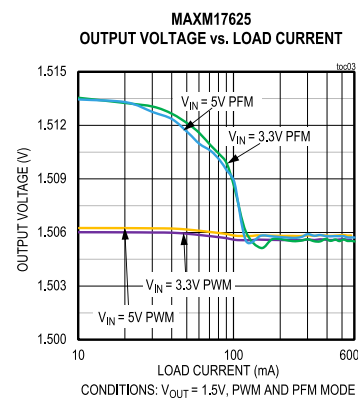
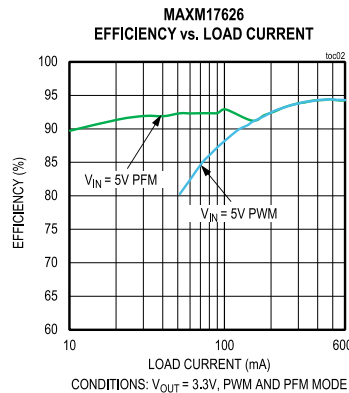
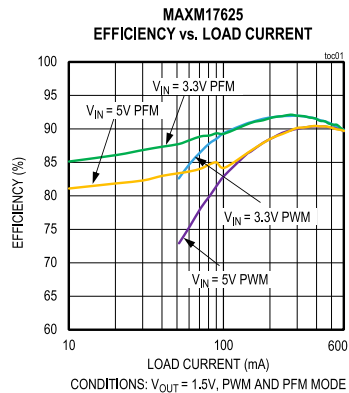

MAXM17625/MAXM17626 EV Kits Performance Report (continued)

($V_{IN} = V_{EN} = 5V$, $V_{SGND} = V_{PGND} = 0V$, LX = Open, $T_A = -40^{\circ}C$ to $+125^{\circ}C$, unless otherwise noted. Typical values are at $T_A = +25^{\circ}C$. All voltages are referenced to SGND, unless otherwise noted.)

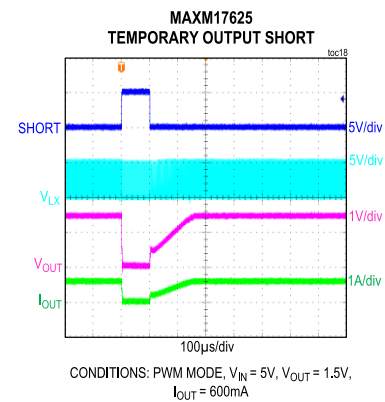
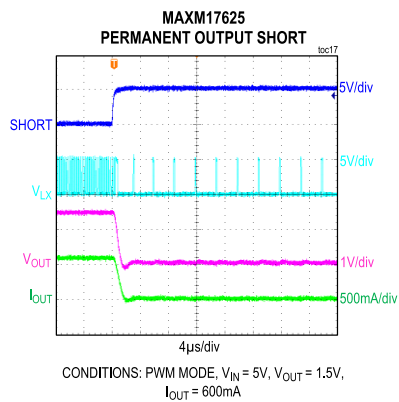
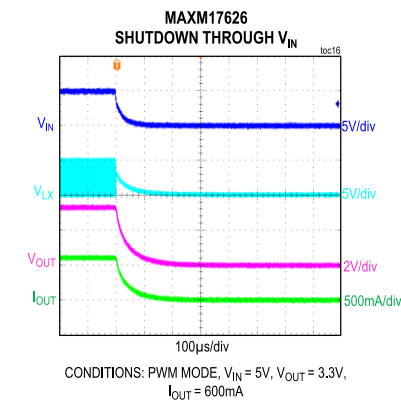
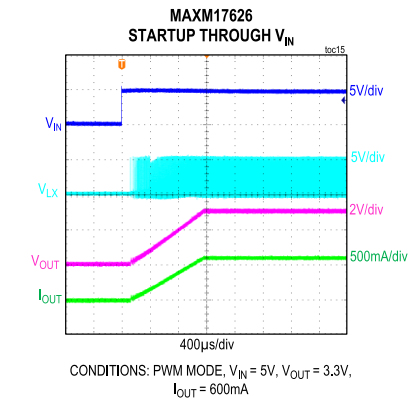
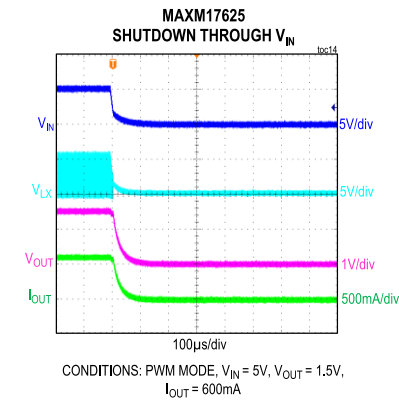
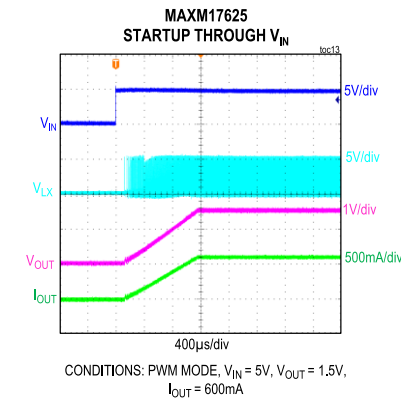
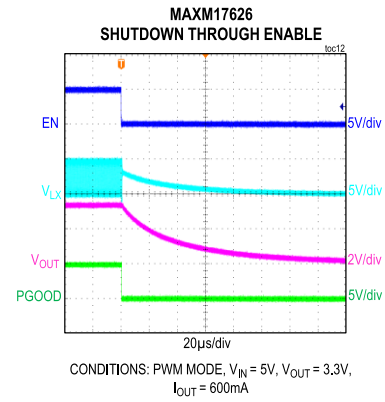
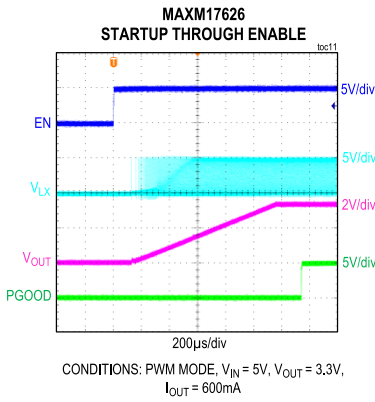
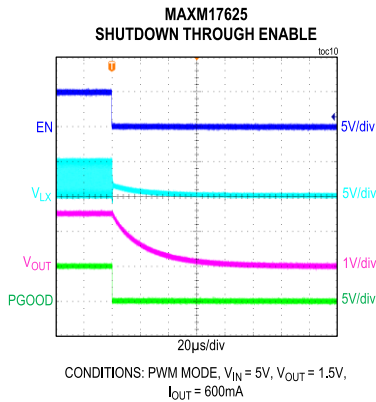

MAXM17625/MAXM17626 EV Kits Performance Report (continued)

($V_{IN} = V_{EN} = 5V$, $V_{SGND} = V_{PGND} = 0V$, LX = Open, $T_A = -40^{\circ}C$ to $+125^{\circ}C$, unless otherwise noted. Typical values are at $T_A = +25^{\circ}C$. All voltages are referenced to SGND, unless otherwise noted.)

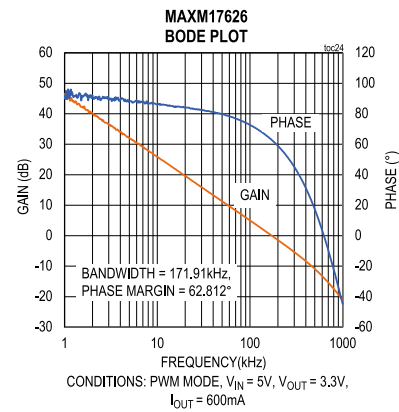
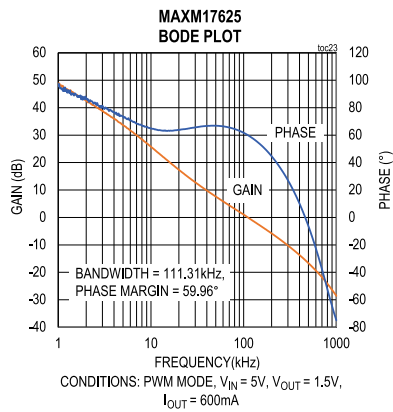
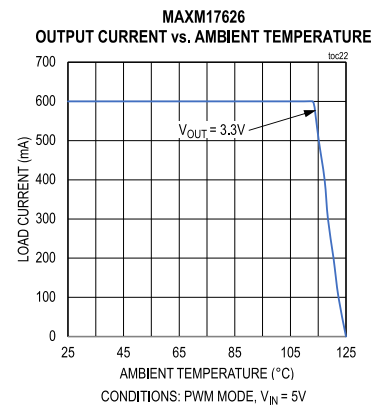
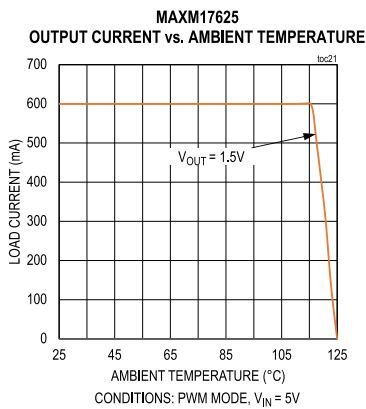
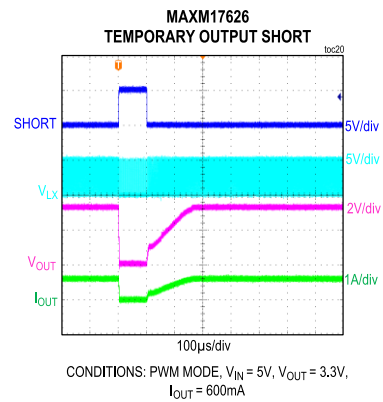
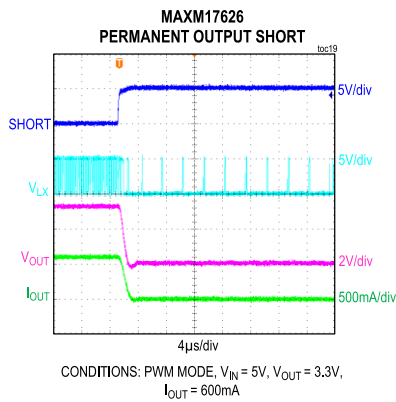

MAXM17625 EV Kit Bill of Materials

ITEM	QTY	DESIGNATOR	DESCRIPTION	MANUFACTURER PART NUMBER
1	2	C101, C106	0.1 μ F \pm 10%, 10V, X7R, Ceramic Capacitor (0402)	TDK C1005X5R1A104K
2	1	C102	47 μ F \pm 20%, 8V, Tantalum Capacitor (3528)	Kemet T520B476M008ATE035
3	1	C103	2.2 μ F \pm 10%, 10V, X7R, Ceramic Capacitor (0603)	Murata GRM188R71A225KE15
4	1	C104	22 μ F \pm 10%, 6.3V, X7R, Ceramic Capacitor (0805)	Murata GRM21BZ70J226ME44
5	1	R101	100k Ω \pm 1%, Resistor (0402)	Panasonic ERJ-2RKF1003
6	1	R102	33.2k Ω \pm 1%, Resistor (0402)	Vishay CRCW04023322FK
7	1	R103	37.4k Ω \pm 1%, Resistor (0402)	Vishay CRCW040237K4FK
8	1	U101	MAXM17625 10pin u-SLIC Power Module	Maxim MAXM17625AMB+
9	1	C105	Package Outline 0805 Capacitor	OPEN

MAXM17626 EV Kit Bill of Materials

ITEM	QTY	DESIGNATOR	DESCRIPTION	MANUFACTURER PART NUMBER
1	2	C201, C206	0.1 μ F \pm 10%, 10V, X7R, Ceramic Capacitor (0402)	TDK C1005X5R1A104K
2	1	C202	47 μ F \pm 20%, 8V, Tantalum Capacitor (3528)	Kemet T520B476M008ATE035
3	1	C203	2.2 μ F \pm 10%, 10V, X7R, Ceramic Capacitor (0603)	Murata GRM188R71A225KE15
4	1	C204	10 μ F \pm 10%, 10V, X7R, Ceramic Capacitor (0603)	Murata GRM188Z71A106KA73
5	1	R201	100k Ω \pm 1%, Resistor (0402)	Panasonic ERJ-2RKF1003
6	1	R202	118k Ω \pm 1%, Resistor (0402)	Panasonic ERJ-2RKF1183
7	1	R203	37.4k Ω \pm 1%, Resistor (0402)	Vishay CRCW040237K4FK
8	1	U201	MAXM17626 10pin u-SLIC Power Module	Maxim MAXM17626AMB+
9	1	C205	Package Outline 0805 Capacitor	OPEN

MAXM17625 EV Kit Schematic

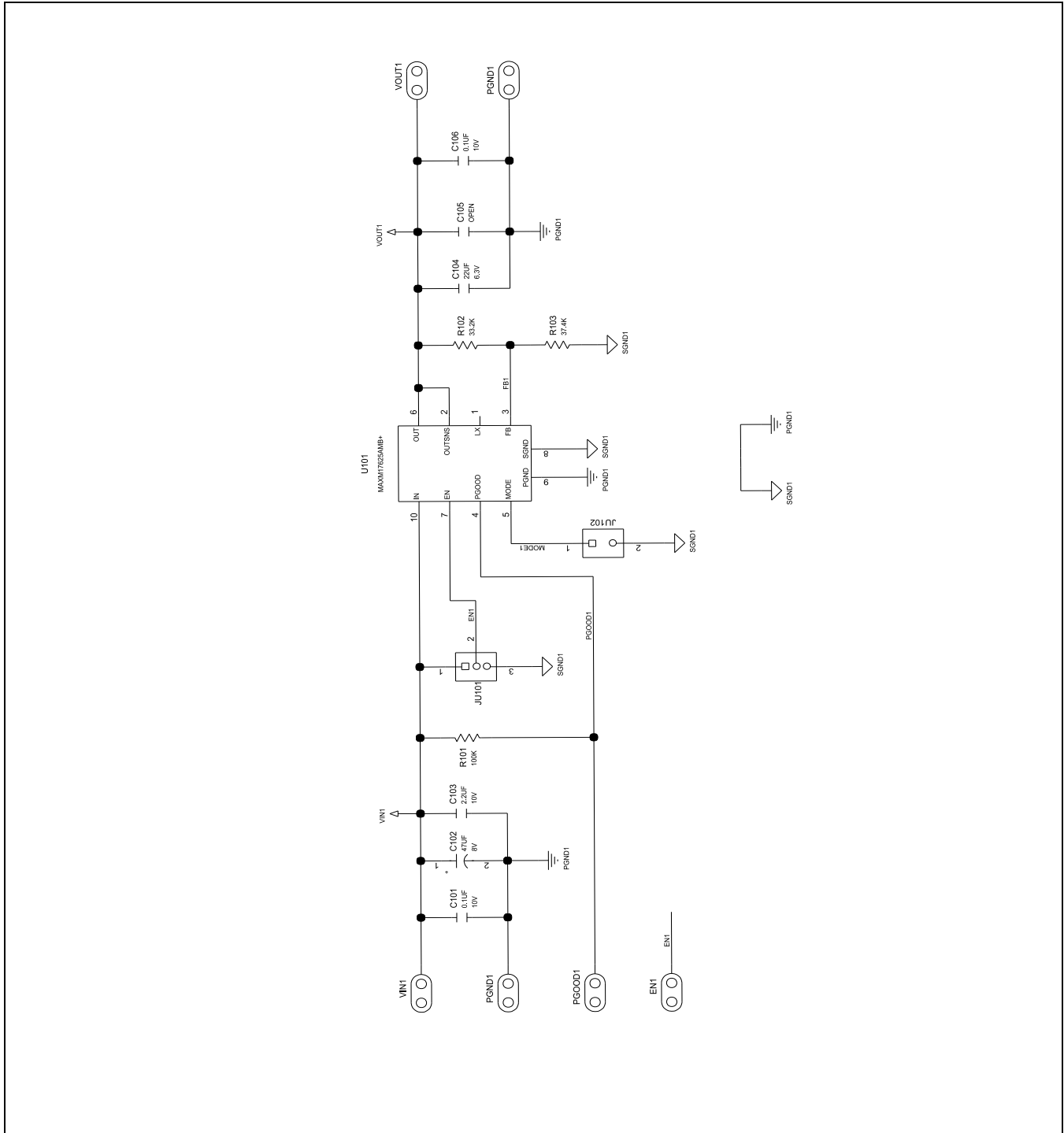

MAXM17626 EV Kit Schematic

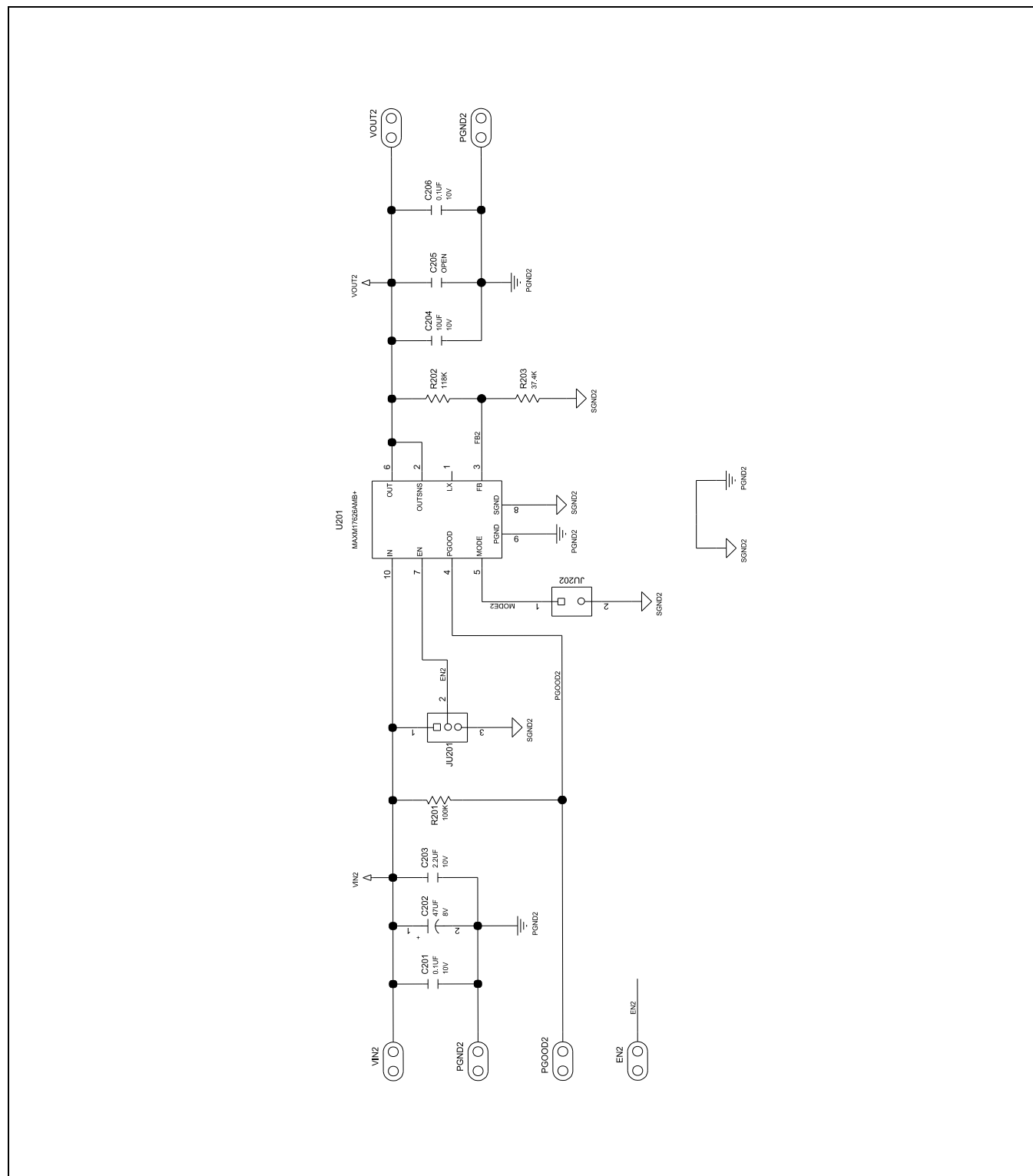

MAXM17625/MAXM17626 EV Kits PCB Layout Diagrams

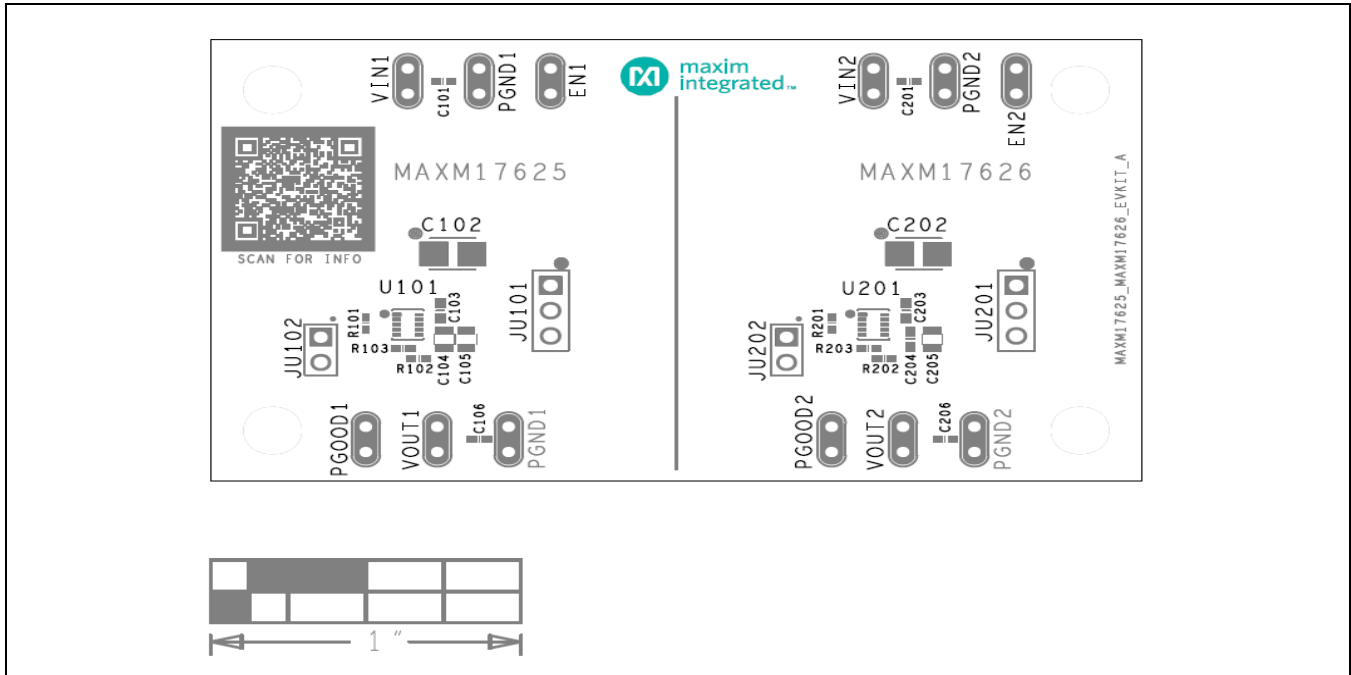

MAXM17625/MAXM17626 EV Kits PCB Layout–Top Silkscreen

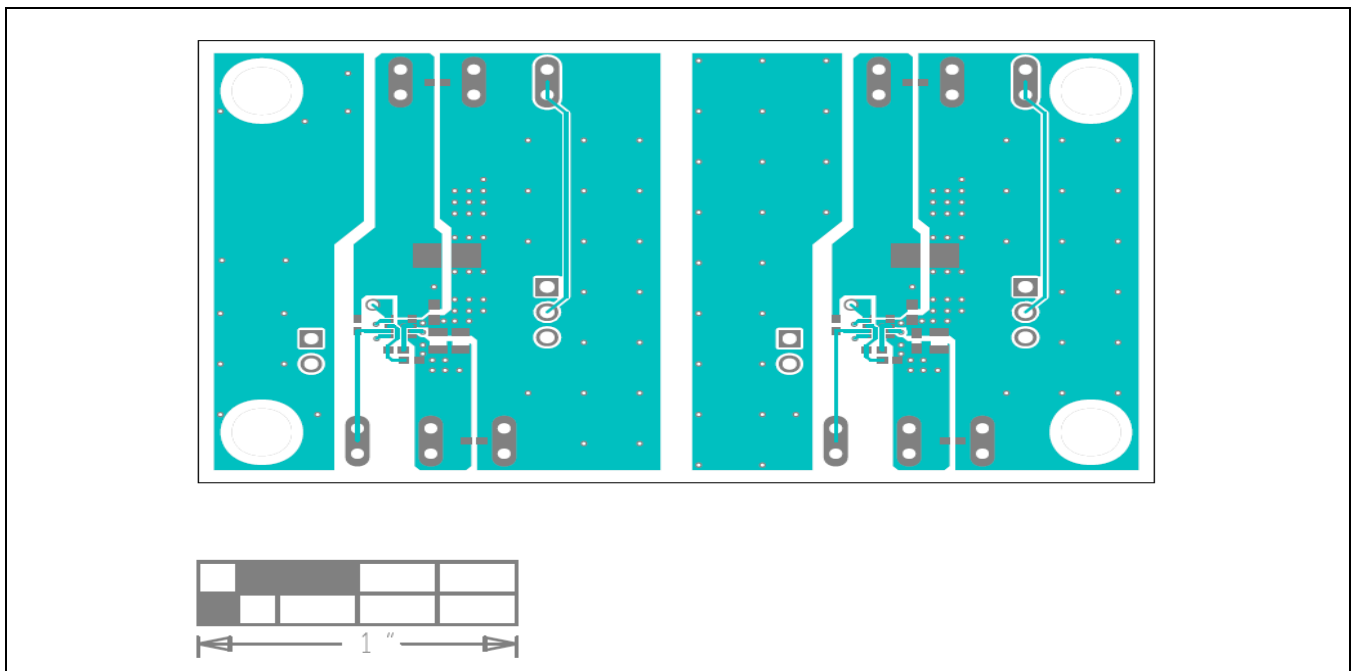

MAXM17625/MAXM17626 EV Kits PCB Layout–Top Layer

MAXM17625/MAXM17626 EV Kits PCB Layout Diagrams (Continued)

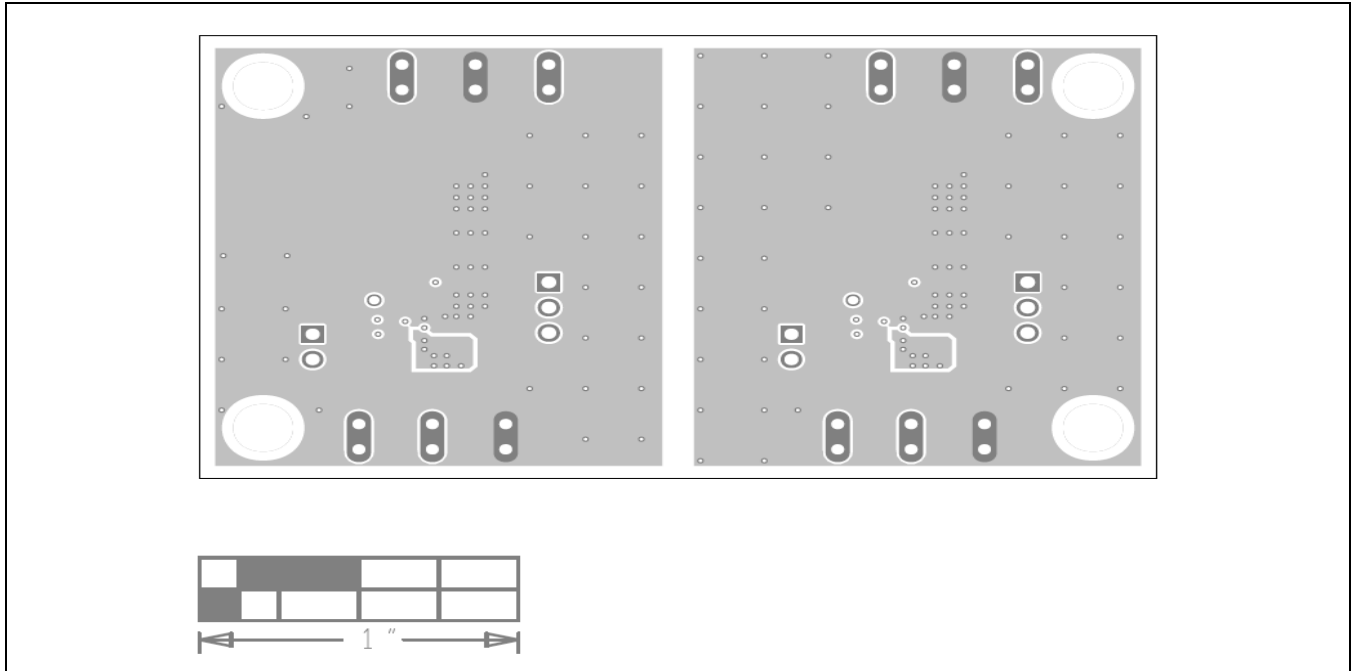

MAXM17625/MAXM17626 EV Kits PCB Layout—Layer 2

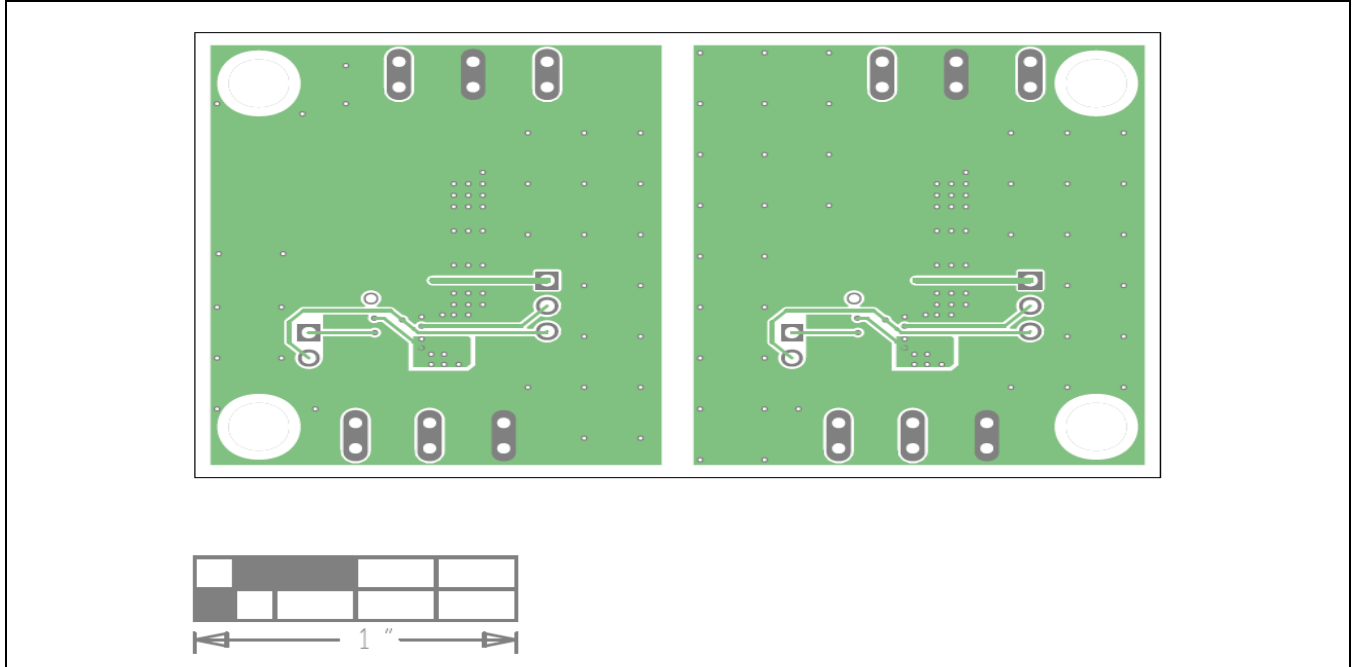

MAXM17625/MAXM17626 EV Kits PCB Layout—Layer 3

MAXM17625/MAXM17626 EV Kits PCB Layout Diagrams (continued)

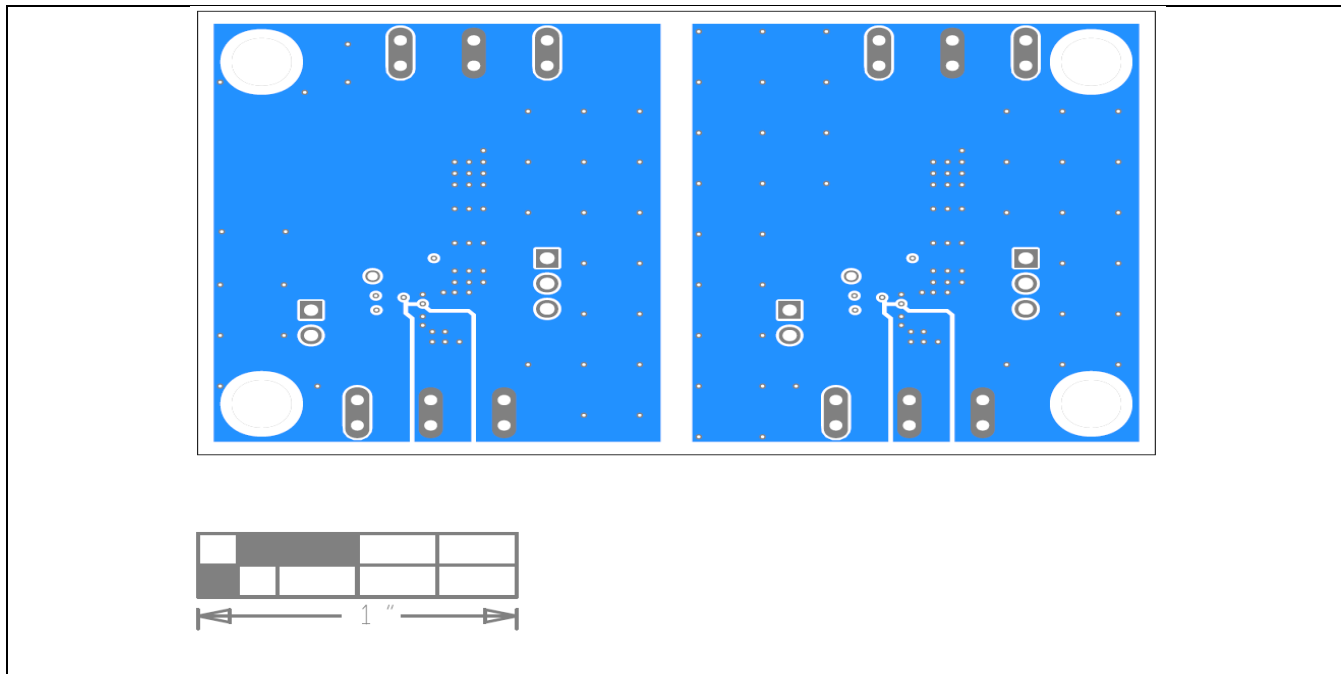

MAXM17625/MAXM17626 EV Kits PCB Layout–Bottom Layer

Ordering Information

PART NUMBER	TYPE
MAXM17625EVKIT#	EV Kit
MAXM17626EVKIT#	EV Kit

#Denotes RoHS compliance.

Component Suppliers

SUPPLIER	WEBSITE
Murata Americas	www.murata.com
Vishay	www.vishay.com
Panasonic	www.panasonic.com
TDK Corp.	www.tdk.com
Kemet	www.kemet.com

Revision History

REVISION NUMBER	REVISION DATE	DESCRIPTION	PAGES CHANGED
0	04/21	Initial release	—

For pricing, delivery, and ordering information, please visit Maxim Integrated's online storefront at <https://www.maximintegrated.com/en/storefront/storefront.html>.

Maxim Integrated cannot assume responsibility for use of any circuitry other than circuitry entirely embodied in a Maxim Integrated product. No circuit patent licenses are implied. Maxim Integrated reserves the right to change the circuitry and specifications without notice at any time. The parametric values (min and max limits) shown in the Electrical Characteristics table are guaranteed. Other parametric values quoted in this data sheet are provided for guidance.