

注記  
NOTES

- 材質  
ウエハー: 耐熱性ナイロン UL94V-0  
ピン: 銅合金、ニッケル下地、錫メッキ、金メッキ  
フィッティングネール: 銅合金、ニッケル下地、錫メッキ  
MATERIAL  
WAFER: POLYAMIDE UL94V-0  
PIN: COPPER ALLOY, GOLD OR TIN OVER NICKEL PLATE.  
FITTING NAIL: COPPER ALLOY, TIN OVER NICKEL PLATE.
- 色: ナチュラル、黒、赤、青  
COLOR: NATURAL, BLACK, RED, BLUE
- 嵌合相手:  
ハウジング: 502351-\*\*0\*  
錫メッキ端子: 50212-8\*00, 50372-8\*00, 560085-0101  
金メッキ端子: 56161-8\*81  
MATES WITH  
HOUSING: 502351-\*\*0\*  
SN PLATING TERMINAL: 50212-8\*00, 50372-8\*00, 560085-0101  
AU PLATING TERMINAL: 56161-8\*81

- インボス梱包品の詳細はSD-560020-002参照  
DETAILED TAPING PACKAGE, SEE SD-560020-002
- 半田付け面のコプラナリティ: 0.1mm MAX.  
CO-PLANARITY OF SOLDER TAILS TO BE 0.1mm MAX.
- 一般公差  
GENERAL TOLERANCES  
10 UNDER: ±0.2  
10 OVER 30 UNDER: ±0.25  
30 OVER: ±0.3  
ANGULAR: ±1°

INITIAL REVISION:

|       |            |            |
|-------|------------|------------|
| DRWN  | SHSHIBATA  | 2009/02/18 |
| CHECK | HKOMATSU   | 2009/02/18 |
| APPR  | AKANESHIGE | 2009/02/18 |

|  |   |                        |              |            |   |
|--|---|------------------------|--------------|------------|---|
| FUNCTIONAL SYMBOLS                                   | THIS DRAWING CONTAINS INFORMATION THAT IS PROPRIETARY TO MOLEX ELECTRONIC TECHNOLOGIES, LLC AND SHOULD NOT BE USED WITHOUT WRITTEN PERMISSION |                        | SCALE        |            | CURRENT REV DESC:   |
|  | mm  | 5:1                    |              |            |   |
| DIVISIONAL SYMBOLS                                   | GENERAL TOLERANCES (UNLESS SPECIFIED)   |                        |              |            | EC NO: 635305<br>DRWN: MUNEMOTO 2020/04/02<br>CHK'D: HIJIMA 2020/04/03<br>APPR: TOSADA 2020/04/06 |
|  | 4 PLACES  | ±                      | MM           | INCH       |   |
| FUNCTIONAL SYMBOLS                                   | 3 PLACES  | ±                      |              |            | INITIAL REVISION:<br>DRWN: DRAWN BY 0099/99/99<br>APPR: APPR BY 0099/99/99                        |
|  | 2 PLACES  | ±                      |              |            |   |
|  | 1 PLACE   | ±                      |              |            |   |
|  | 0 PLACES  | ±                      |              |            |   |
|  | ANGULAR TOL   | ±                      | °            |            |   |
| DRAFT WHERE APPLICABLE MUST REMAIN WITHIN DIMENSIONS |   | THIRD ANGLE PROJECTION |              | DRAWING    | SERIES  |
|  |   | A3-SIZE                |              | 560020     |   |
| DOCUMENT STATUS                                      |   | P1                     | RELEASE DATE | 2020/04/06 | 00:33:42  |

**molex**

2.0MM PITCH W/B CONN.  
WAFER ASSY ST. SMT

PRODUCT CUSTOMER DRAWING

|                 |          |          |          |
|-----------------|----------|----------|----------|
| DOCUMENT NUMBER | DOC TYPE | DOC PART | REVISION |
| SD-560020-001   | PSD      | 001      | K        |

MATERIAL NUMBER: GENERAL MARKET  
CUSTOMER: GENERAL MARKET  
SHEET NUMBER: 1 OF 4

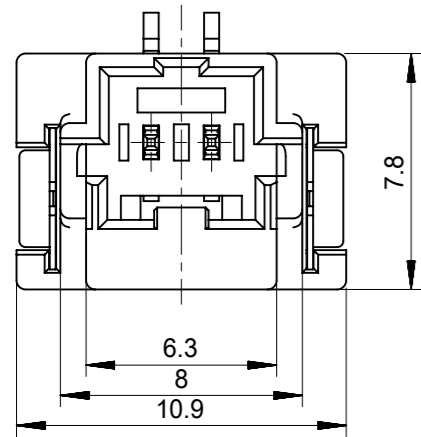

2CKTS

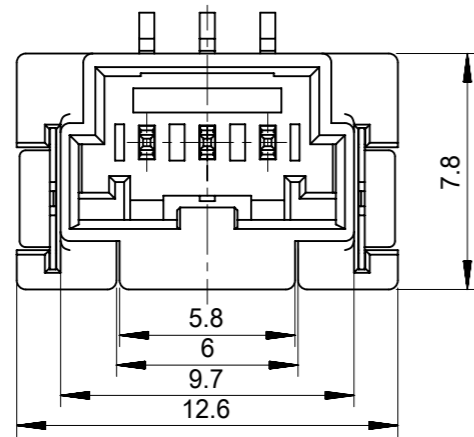

3CKTS

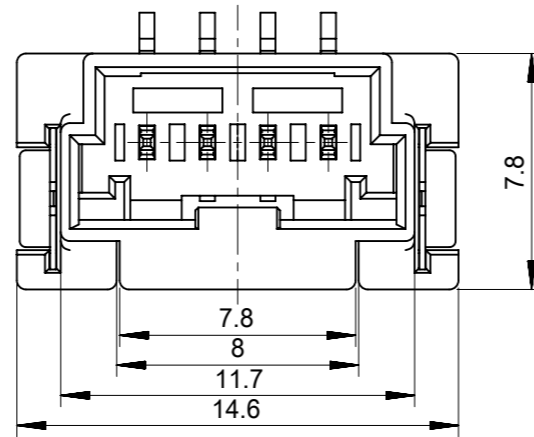

4CKTS

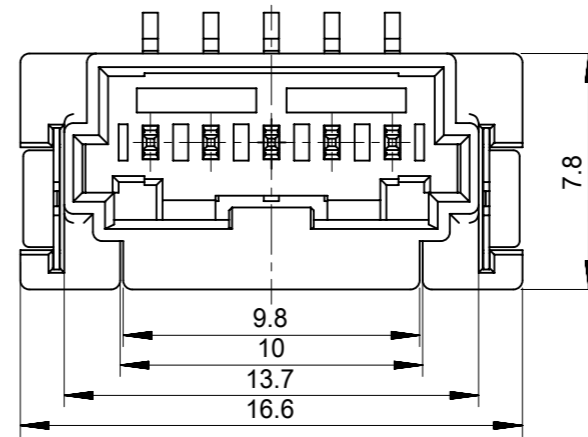

5CKTS

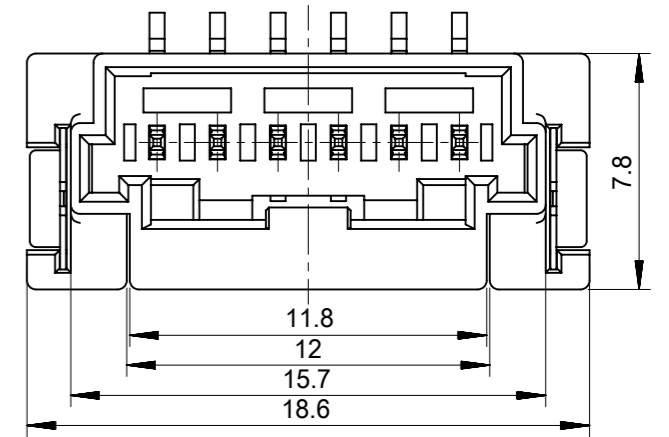

6CKTS

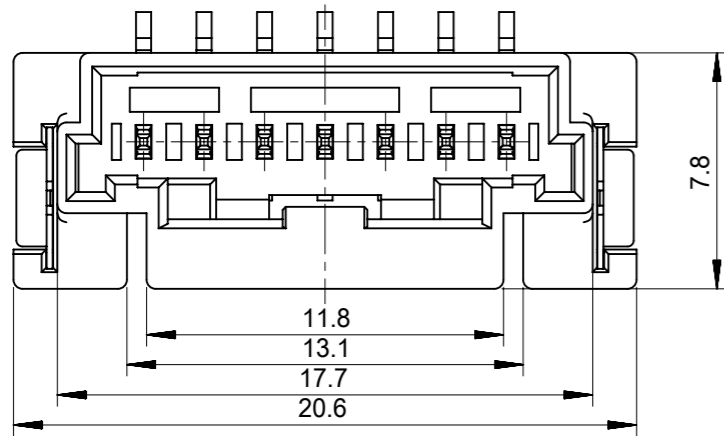
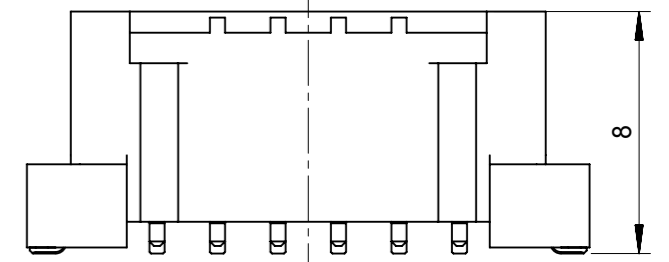
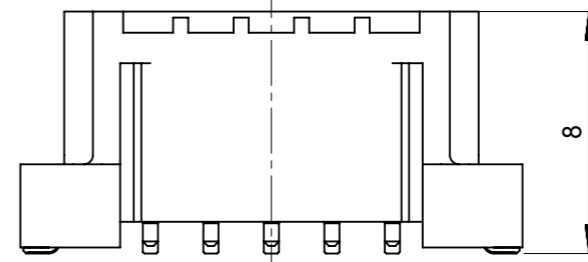
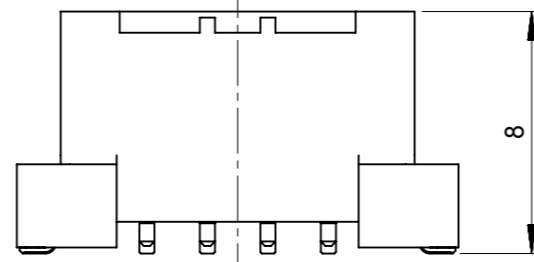
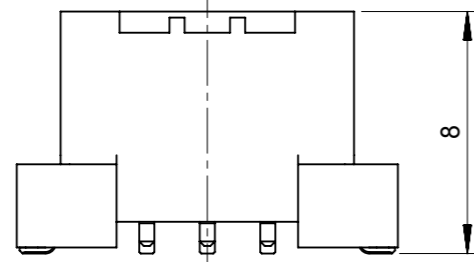
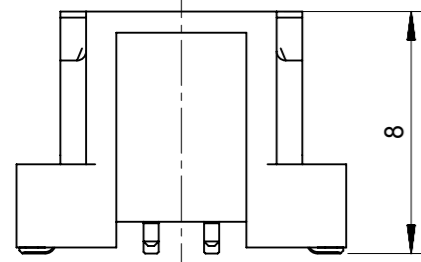

7CKTS

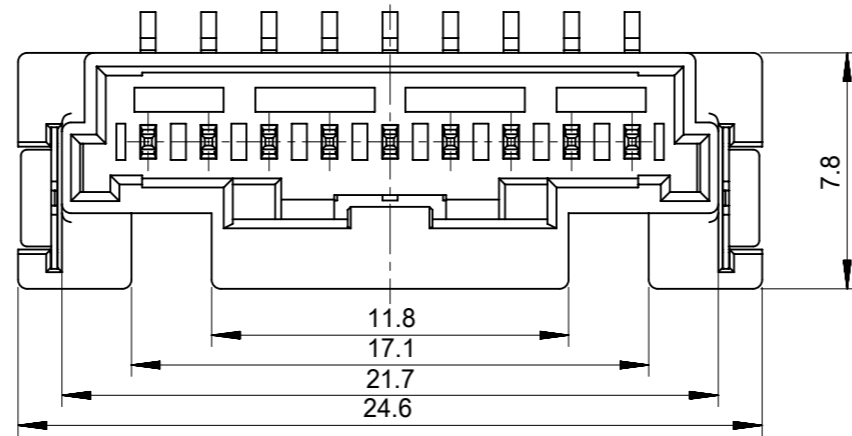

9CKTS

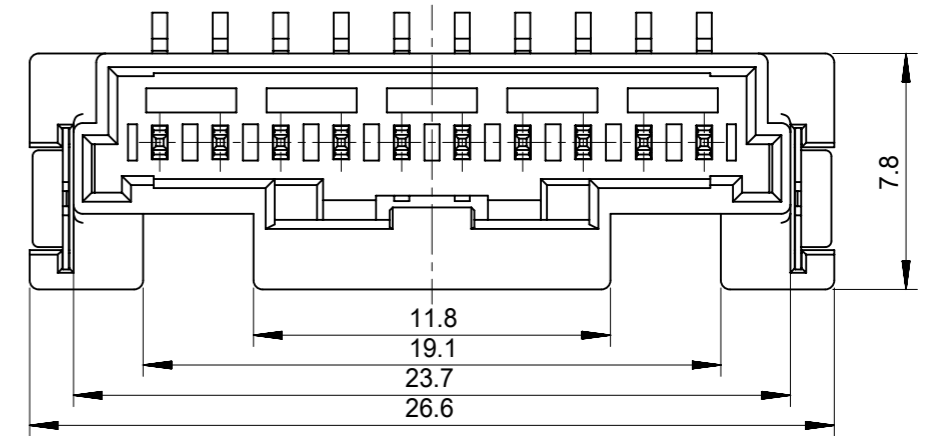

10CKTS

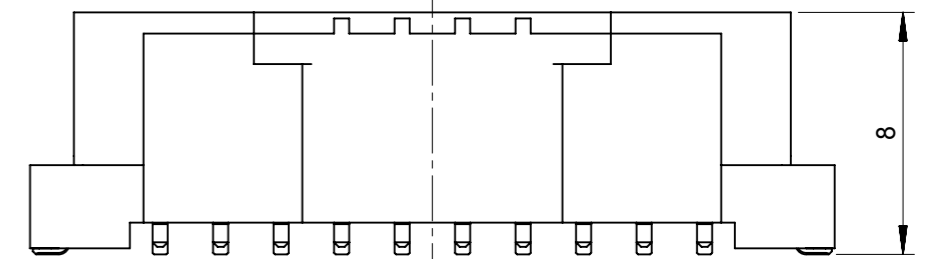
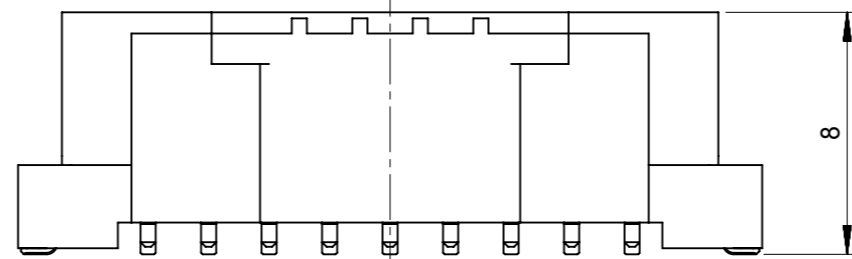
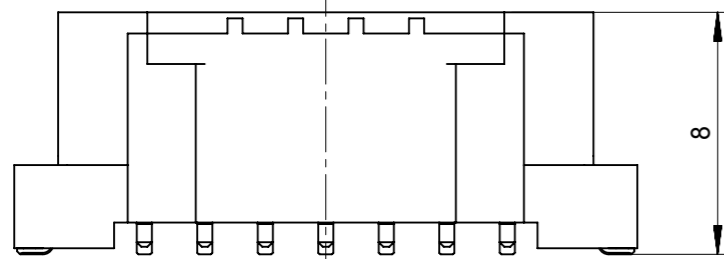

INITIAL REVISION:  
 DRWN SHSHIBATA 2009/02/18  
 CHECK HKOMATSU 2009/02/18  
 APPR AKANESHIGE 2009/02/18

|  |   |  |   |                         |                          |
|--|---|--|---|-------------------------|--------------------------|
| FUNCTIONAL SYMBOLS<br>FA = 0<br>FB = 0<br>FC = 0 | THIS DRAWING CONTAINS INFORMATION THAT IS PROPRIETARY TO MOLEX ELECTRONIC TECHNOLOGIES, LLC AND SHOULD NOT BE USED WITHOUT WRITTEN PERMISSION |  | CURRENT REV DESC:   |                         |                          |
|  | DIMENSION UNITS<br>mm   | SCALE<br>4:1   | EC NO: 635305<br>DRWN: MUNEMOTO 2020/04/02<br>CHK'D: HIJIMA 2020/04/03<br>APPR: TOSADA 2020/04/06 |                         |                          |
| DIVISIONAL SYMBOLS                               | GENERAL TOLERANCES (UNLESS SPECIFIED)   |  | INITIAL REVISION:   |                         | PRODUCT CUSTOMER DRAWING |
|  | 4 PLACES ±  | 3 PLACES ±   | 2 PLACES ±  | 1 PLACE ±               | 0 PLACES ±               |
| ANGULAR TOL ± °                                  |   | DRAFT WHERE APPLICABLE MUST REMAIN WITHIN DIMENSIONS |   | THIRD ANGLE PROJECTION  | DRAWING A3-SIZE          |
| SERIES 560020                                    |   | MATERIAL NUMBER                                      |   | CUSTOMER GENERAL MARKET | SHEET NUMBER 2 OF 4      |

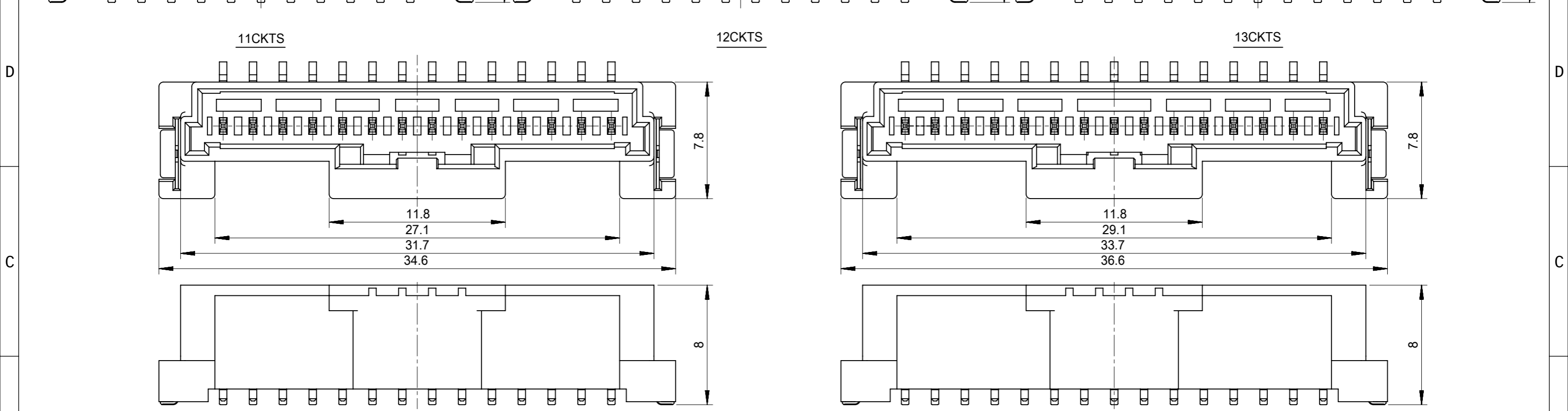
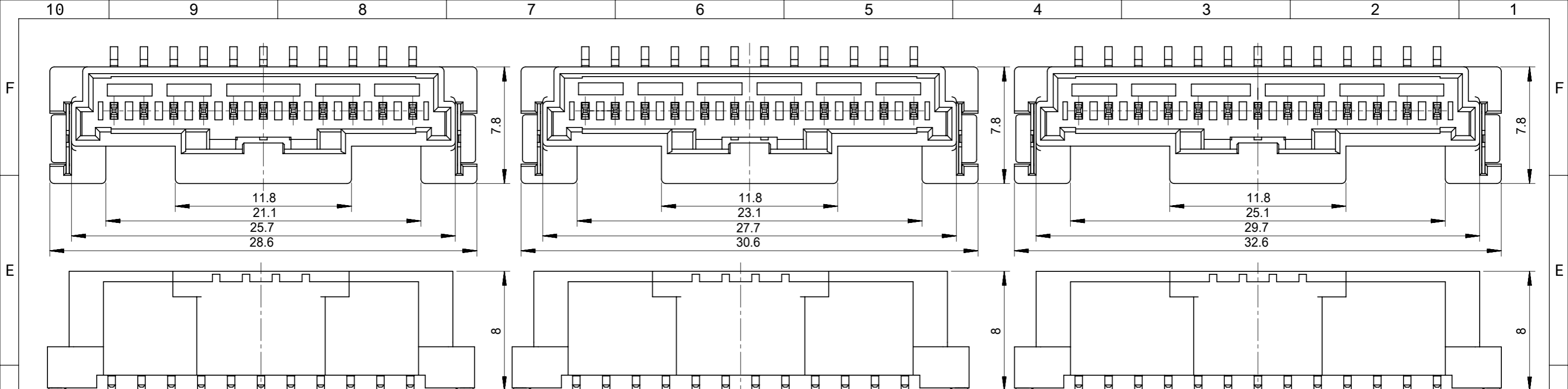

|    |   |   |   |   |   |   |   |   |   |   |
|----|---|---|---|---|---|---|---|---|---|---|
| 10 | 9 | 8 | 7 | 6 | 5 | 4 | 3 | 2 | 1 |   |
| F  |   |   |   |   |   |   |   |   |   | F |
| E  |   |   |   |   |   |   |   |   |   | E |
| D  |   |   |   |   |   |   |   |   |   | D |
| C  |   |   |   |   |   |   |   |   |   | C |
| B  |   |   |   |   |   |   |   |   |   | B |
| A  |   |   |   |   |   |   |   |   |   | A |

11CKTS

12CKTS

13CKTS

14CKTS

15CKTS

| FUNCTIONAL SYMBOLS  | THIS DRAWING CONTAINS INFORMATION THAT IS PROPRIETARY TO MOLEX ELECTRONIC TECHNOLOGIES, LLC AND SHOULD NOT BE USED WITHOUT WRITTEN PERMISSION   |                   |  |  |  |    |      |          |   |   |          |   |   |          |   |   |         |   |   |          |   |   |
|---|---|-------------------|--|--|--|----|------|----------|---|---|----------|---|---|----------|---|---|---------|---|---|----------|---|---|
| $\nabla_A = 0$<br>$\nabla_F = 0$<br>$\nabla_P = 0$  | DIMENSION UNITS: <b>mm</b><br>SCALE: <b>4:1</b>   | CURRENT REV DESC: |  |  |  |    |      |          |   |   |          |   |   |          |   |   |         |   |   |          |   |   |
| DIVISIONAL SYMBOLS  | GENERAL TOLERANCES (UNLESS SPECIFIED)   |                   | EC NO: 635305<br>DRWN: MUNEMOTO 2020/04/02<br>CHK'D: HIJIMA 2020/04/03<br>APPR: TOSADA 2020/04/06                  |  |  |    |      |          |   |   |          |   |   |          |   |   |         |   |   |          |   |   |
|   | <table border="1" style="width:100%; border-collapse: collapse;"> <thead> <tr> <th></th> <th>MM</th> <th>INCH</th> </tr> </thead> <tbody> <tr> <td>4 PLACES</td> <td>±</td> <td>±</td> </tr> <tr> <td>3 PLACES</td> <td>±</td> <td>±</td> </tr> <tr> <td>2 PLACES</td> <td>±</td> <td>±</td> </tr> <tr> <td>1 PLACE</td> <td>±</td> <td>±</td> </tr> <tr> <td>0 PLACES</td> <td>±</td> <td>±</td> </tr> </tbody> </table> |                   |  |  |  | MM | INCH | 4 PLACES | ± | ± | 3 PLACES | ± | ± | 2 PLACES | ± | ± | 1 PLACE | ± | ± | 0 PLACES | ± | ± |
|   | MM  | INCH              |  |  |  |    |      |          |   |   |          |   |   |          |   |   |         |   |   |          |   |   |
| 4 PLACES  | ±   | ±                 |  |  |  |    |      |          |   |   |          |   |   |          |   |   |         |   |   |          |   |   |
| 3 PLACES  | ±   | ±                 |  |  |  |    |      |          |   |   |          |   |   |          |   |   |         |   |   |          |   |   |
| 2 PLACES  | ±   | ±                 |  |  |  |    |      |          |   |   |          |   |   |          |   |   |         |   |   |          |   |   |
| 1 PLACE   | ±   | ±                 |  |  |  |    |      |          |   |   |          |   |   |          |   |   |         |   |   |          |   |   |
| 0 PLACES  | ±   | ±                 |  |  |  |    |      |          |   |   |          |   |   |          |   |   |         |   |   |          |   |   |
|   | DRAFT WHERE APPLICABLE MUST REMAIN WITHIN DIMENSIONS  |                   | THIRD ANGLE PROJECTION<br>   | DRAWING: <b>A3-SIZE</b><br>SERIES: <b>560020</b> |  |    |      |          |   |   |          |   |   |          |   |   |         |   |   |          |   |   |
| INITIAL REVISION:<br>DRWN SHSHIBATA 2009/02/18<br>CHECK HKOMATSU 2009/02/18<br>APPR AKANESHIGE 2009/02/18 |   |                   | PRODUCT CUSTOMER DRAWING<br>DOCUMENT NUMBER: <b>SD-560020-001</b><br>DOC TYPE: PSD<br>DOC PART: 001<br>REVISION: K |  |  |    |      |          |   |   |          |   |   |          |   |   |         |   |   |          |   |   |
| MATERIAL NUMBER: GENERAL MARKET<br>CUSTOMER: GENERAL MARKET   |   |                   | SHEET NUMBER: 3 OF 4   |  |  |    |      |          |   |   |          |   |   |          |   |   |         |   |   |          |   |   |

|                 |    |              |            |          |
|-----------------|----|--------------|------------|----------|
| DOCUMENT STATUS | P1 | RELEASE DATE | 2020/04/06 | 00:33:42 |
|-----------------|----|--------------|------------|----------|

|                                  |      |      |      |      |                            |      |
|----------------------------------|------|------|------|------|----------------------------|------|
| Sn<br>NATURAL                    | 11.8 | 29.1 | 33.7 | 36.6 | 560020-1520                | 15   |
|                                  | 11.8 | 27.1 | 31.7 | 34.6 | 560020-1420                | 14   |
|                                  | 11.8 | 25.1 | 29.7 | 32.6 | 560020-1320                | 13   |
|                                  | 11.8 | 23.1 | 27.7 | 30.6 | 560020-1220                | 12   |
|                                  | 11.8 | 21.1 | 25.7 | 28.6 | 560020-1120                | 11   |
|                                  | 11.8 | 19.1 | 23.7 | 26.6 | 560020-1020                | 10   |
|                                  | 11.8 | 17.1 | 21.7 | 24.6 | 560020-0920                | 9    |
|                                  | 11.8 | 15.1 | 19.7 | 22.6 | 560020-0820                | 8    |
|                                  | 11.8 | 13.1 | 17.7 | 20.6 | 560020-0720                | 7    |
|                                  | 11.8 | 12   | 15.7 | 18.6 | 560020-0620                | 6    |
|                                  | 9.8  | 10   | 13.7 | 16.6 | 560020-0520                | 5    |
|                                  | 7.8  | 8    | 11.7 | 14.6 | 560020-0420                | 4    |
|                                  | 5.8  | 6    | 9.7  | 12.6 | 560020-0320                | 3    |
|                                  | 6.3  | /    | 8.0  | 10.9 | 560020-0220                | 2    |
| PLATING COLOR                    | D    | C    | B    | A    | EMBOSSED PACKAGE ORDER NO. | CKTS |
| CONNECTOR SERIES NO. 560020-**08 |      |      |      |      |                            |      |

|                                  |      |      |      |      |                            |      |
|----------------------------------|------|------|------|------|----------------------------|------|
| Au<br>NATURAL                    | 11.8 | 29.1 | 33.7 | 36.6 | 560020-1530                | 15   |
|                                  | 11.8 | 27.1 | 31.7 | 34.6 | 560020-1430                | 14   |
|                                  | 11.8 | 25.1 | 29.7 | 32.6 | 560020-1330                | 13   |
|                                  | 11.8 | 23.1 | 27.7 | 30.6 | 560020-1230                | 12   |
|                                  | 11.8 | 21.1 | 25.7 | 28.6 | 560020-1130                | 11   |
|                                  | 11.8 | 19.1 | 23.7 | 26.6 | 560020-1030                | 10   |
|                                  | 11.8 | 17.1 | 21.7 | 24.6 | 560020-0930                | 9    |
|                                  | 11.8 | 15.1 | 19.7 | 22.6 | 560020-0830                | 8    |
|                                  | 11.8 | 13.1 | 17.7 | 20.6 | 560020-0730                | 7    |
|                                  | 11.8 | 12   | 15.7 | 18.6 | 560020-0630                | 6    |
|                                  | 9.8  | 10   | 13.7 | 16.6 | 560020-0530                | 5    |
|                                  | 7.8  | 8    | 11.7 | 14.6 | 560020-0430                | 4    |
|                                  | 5.8  | 6    | 9.7  | 12.6 | 560020-0330                | 3    |
|                                  | 6.3  | /    | 8.0  | 10.9 | 560020-0230                | 2    |
| PLATING COLOR                    | D    | C    | B    | A    | EMBOSSED PACKAGE ORDER NO. | CKTS |
| CONNECTOR SERIES NO. 560020-**18 |      |      |      |      |                            |      |

|                                  |      |      |      |      |                            |      |
|----------------------------------|------|------|------|------|----------------------------|------|
| Sn<br>BLACK                      | 11.8 | 29.1 | 33.7 | 36.6 | 560020-1521                | 15   |
|                                  | 11.8 | 27.1 | 31.7 | 34.6 | 560020-1421                | 14   |
|                                  | 11.8 | 25.1 | 29.7 | 32.6 | 560020-1321                | 13   |
|                                  | 11.8 | 23.1 | 27.7 | 30.6 | 560020-1221                | 12   |
|                                  | 11.8 | 21.1 | 25.7 | 28.6 | 560020-1121                | 11   |
|                                  | 11.8 | 19.1 | 23.7 | 26.6 | 560020-1021                | 10   |
|                                  | 11.8 | 17.1 | 21.7 | 24.6 | 560020-0921                | 9    |
|                                  | 11.8 | 15.1 | 19.7 | 22.6 | 560020-0821                | 8    |
|                                  | 11.8 | 13.1 | 17.7 | 20.6 | 560020-0721                | 7    |
|                                  | 11.8 | 12   | 15.7 | 18.6 | 560020-0621                | 6    |
|                                  | 9.8  | 10   | 13.7 | 16.6 | 560020-0521                | 5    |
|                                  | 7.8  | 8    | 11.7 | 14.6 | 560020-0421                | 4    |
|                                  | 5.8  | 6    | 9.7  | 12.6 | 560020-0321                | 3    |
|                                  | 6.3  | /    | 8.0  | 10.9 | 560020-0221                | 2    |
| PLATING COLOR                    | D    | C    | B    | A    | EMBOSSED PACKAGE ORDER NO. | CKTS |
| CONNECTOR SERIES NO. 560020-**28 |      |      |      |      |                            |      |

|                                  |      |      |      |      |                            |      |
|----------------------------------|------|------|------|------|----------------------------|------|
| Sn<br>RED                        | /    | /    | /    | /    | /                          | 15   |
|                                  | /    | /    | /    | /    | /                          | 14   |
|                                  | /    | /    | /    | /    | /                          | 13   |
|                                  | /    | /    | /    | /    | /                          | 12   |
|                                  | /    | /    | /    | /    | /                          | 11   |
|                                  | /    | /    | /    | /    | /                          | 10   |
|                                  | /    | /    | /    | /    | /                          | 9    |
|                                  | 11.8 | 15.1 | 19.7 | 22.6 | 560020-0822                | 8    |
|                                  | /    | /    | /    | /    | /                          | 7    |
|                                  | 11.8 | 12   | 15.7 | 18.6 | 560020-0622                | 6    |
|                                  | /    | /    | /    | /    | /                          | 5    |
|                                  | 7.8  | 8    | 11.7 | 14.6 | 560020-0422                | 4    |
|                                  | 5.8  | 6    | 9.7  | 12.6 | 560020-0322                | 3    |
|                                  | 6.3  | /    | 8.0  | 10.9 | 560020-0222                | 2    |
| PLATING COLOR                    | D    | C    | B    | A    | EMBOSSED PACKAGE ORDER NO. | CKTS |
| CONNECTOR SERIES NO. 560020-**48 |      |      |      |      |                            |      |

|                                  |      |      |      |      |                            |      |
|----------------------------------|------|------|------|------|----------------------------|------|
| Sn<br>BLUE                       | /    | /    | /    | /    | /                          | 15   |
|                                  | /    | /    | /    | /    | /                          | 14   |
|                                  | /    | /    | /    | /    | /                          | 13   |
|                                  | /    | /    | /    | /    | /                          | 12   |
|                                  | /    | /    | /    | /    | /                          | 11   |
|                                  | /    | /    | /    | /    | /                          | 10   |
|                                  | /    | /    | /    | /    | /                          | 9    |
|                                  | 11.8 | 15.1 | 19.7 | 22.6 | 560020-0823                | 8    |
|                                  | /    | /    | /    | /    | /                          | 7    |
|                                  | 11.8 | 12   | 15.7 | 18.6 | 560020-0623                | 6    |
|                                  | /    | /    | /    | /    | /                          | 5    |
|                                  | 7.8  | 8    | 11.7 | 14.6 | 560020-0423                | 4    |
|                                  | 5.8  | 6    | 9.7  | 12.6 | 560020-0323                | 3    |
|                                  | 6.3  | /    | 8.0  | 10.9 | 560020-0223                | 2    |
| PLATING COLOR                    | D    | C    | B    | A    | EMBOSSED PACKAGE ORDER NO. | CKTS |
| CONNECTOR SERIES NO. 560020-**68 |      |      |      |      |                            |      |

INITIAL REVISION:  
 DRWN SHSHIBATA 2009/02/18  
 CHECK HKOMATSU 2009/02/18  
 APPR AKANESHIGE 2009/02/18

|                    |                                       |   |                           |
|--------------------|---------------------------------------|---|---------------------------|
| FUNCTIONAL SYMBOLS |                                       | THIS DRAWING CONTAINS INFORMATION THAT IS PROPRIETARY TO MOLEX ELECTRONIC TECHNOLOGIES, LLC AND SHOULD NOT BE USED WITHOUT WRITTEN PERMISSION |                           |
| FA = 0             | mm                                    | SCALE 1:1   | CURRENT REV DESC:         |
| FB = 0             | GENERAL TOLERANCES (UNLESS SPECIFIED) |   | EC NO: 635305             |
| FC = 0             | MM INCH                               |   | DRWN: MUNEMOTO 2020/04/02 |
| DIVISIONAL SYMBOLS |                                       | 4 PLACES ±  | CHK'D: HIJIMA 2020/04/03  |
|                    |                                       | 3 PLACES ±  | APPR: TOSADA 2020/04/06   |
|                    |                                       | 2 PLACES ±  | INITIAL REVISION:         |
|                    |                                       | 1 PLACE ±   | DRWN: DRAWN BY 0099/99/99 |
|                    |                                       | 0 PLACES ±  | APPR: APPR BY 0099/99/99  |
| ANGULAR TOL ± °    |                                       | DRAFT WHERE APPLICABLE MUST REMAIN WITHIN DIMENSIONS  | THIRD ANGLE PROJECTION    |
|                    |                                       | DRAWING A3-SIZE   | SERIES 560020             |
|                    |                                       | MATERIAL NUMBER   | CUSTOMER GENERAL MARKET   |
|                    |                                       | DOCUMENT NUMBER SD-560020-001   | DOC TYPE PSD              |
|                    |                                       | DOC PART 001  | REVISION K                |
|                    |                                       | SHEET NUMBER 4 OF 4   |                           |