

R79IC2180DQ45J

Aliases (79IC2180DQ45J)

Not for New Design

R79, Film, Metallized Polypropylene, General Purpose, 0.018 uF, 5%, 250 VDC, 85°C, Lead Spacing = 5mm

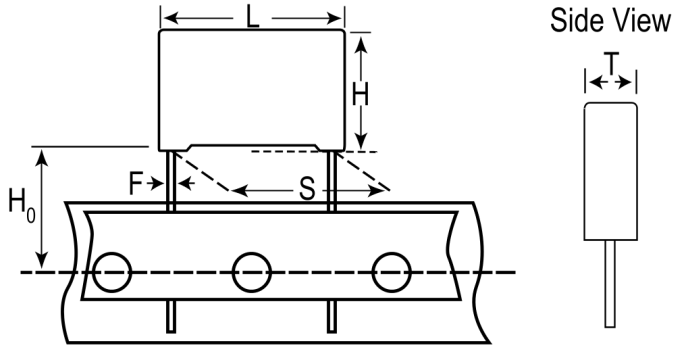

Click [here](#) for the 3D model.

Dimensions

L	7.2mm +0.2/-0.5mm
H	7.5mm +0.1/-0.5mm
T	3.5mm +0.1/-0.5mm
S	5mm +0.6/-0.1mm
H0	18.5mm +/-0.5mm
F	0.5mm +/-0.05mm

Packaging Specifications

Packaging	Ammo, 360x340x59mm, Box
Packaging Quantity	2500

General Information

Series	R79
Dielectric	Metallized Polypropylene
Style	Radial
Features	Pulse
RoHS	Yes
Lead	Wire Leads
AEC-Q200	No
Component Weight	0.3 g
Miscellaneous	Above 85C DC And AC Voltage Derating Is 1.25%/C.
Notes	Series Replaced by R75.

Specifications

Capacitance	0.018 uF
Capacitance Tolerance	5%
Voltage AC	160 VAC
Voltage DC	250 VDC
Temperature Range	-55/+105°C
Rated Temperature	85°C
Dissipation Factor	0.06% 1kHz, 0.1% 10kHz, 0.3% 100kHz
Insulation Resistance	100 GOhms
Max dV/dt	250 V/us
Inductance	6 nH