

10 9 8 7 6 5 4 3 2 1

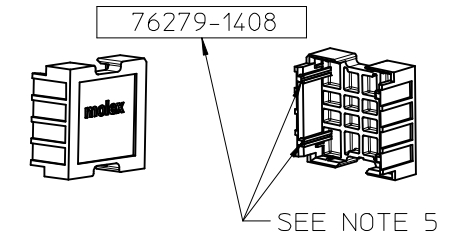
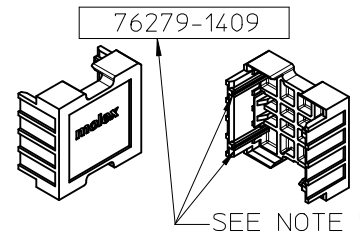
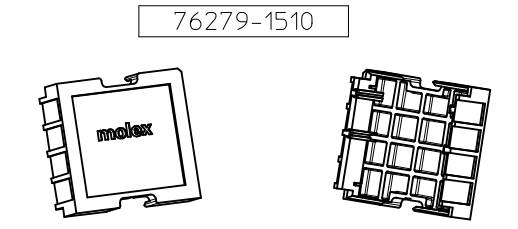
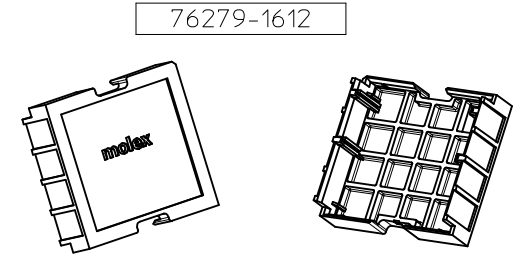
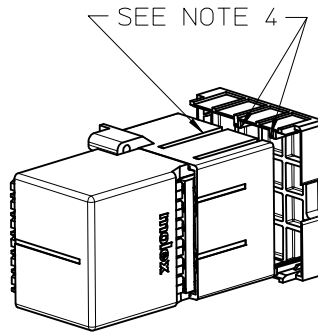
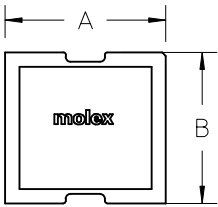
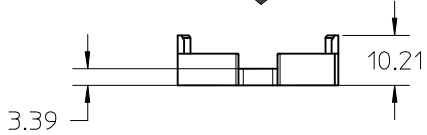
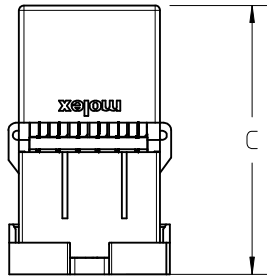
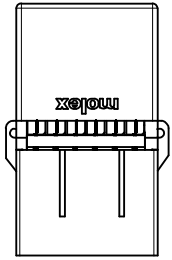

NOTES:

1. MATERIAL: ABS
COLOR: NATURAL (WHITE)
2. COVERS FIT BOTH GUIDED AND UNGUIDED CONFIGURATIONS.
3. THIS PART CONFORMS TO CLASS B REQUIREMENTS OF COSMETIC SPEC PS-45499-002
4. INTERNAL COVER RIBS ALIGN WITH SLOTS ON CONNECTOR HOUSING
5. ONLY MATES WITH TWO SLOT 4 PAIR OD-RAM
6. PLEASE SEE RAS-76279-9999 FOR DUST COVER USAGE AND REAPPLICATION GUIDELINES.

PART NUMBER	NUMBER OF PAIRS	NUMBER OF COLUMNS	DIM "A"	DIM "B"	DIM "C"
76279-1612	6 PAIR	12 COLUMN	32.9	30.9	55
76279-1510	5 PAIR	10 COLUMN	27.9	26.9	50
76279-1408	4 PAIR	8 COLUMN	23.8	22.8	46
76279-1409	4 PAIR/TOP GUIDE	8 COLUMN			

ADD 76279-1409 EC NO: UCP2015-3274 DRWN:BJ MILLER 2015/01/12 CHKD: APPR:TELO 2015/02/12 REV A	QUALITY SYMBOLS	GENERAL TOLERANCES (UNLESS SPECIFIED)	DIMENSION STYLE MM ONLY	SCALE 1:1	DESIGN UNITS METRIC	THIRD ANGLE PROJECTION
	▽/0	4 PLACES ± --- ± ---	mm INCH	DRAWN BY BJ MILLER	DATE 2013/08/09	TITLE IMPACT ORTHOGONAL DIRECT PROTECTIVE DUST COVERS
	▽/0	3 PLACES ± --- ± ---		CHECKED BY	DATE	
	▽/0	2 PLACES ± 0.13 ± ---		APPROVED BY TELO	DATE 2015/02/12	
		1 PLACE ± 0.25 ± ---		MATERIAL NO.	DOCUMENT NO.	SHEET NO.
		0 PLACE ± --- ± ---		SEE CHART	SD-76279-1612	1 OF 1
		ANGULAR ± 1/2°		THIS DRAWING CONTAINS INFORMATION THAT IS PROPRIETARY TO MOLEX INCORPORATED AND SHOULD NOT BE USED WITHOUT WRITTEN PERMISSION		
		DRAFT WHERE APPLICABLE				
		MUST REMAIN WITHIN DIMENSIONS				

9 8 7 6 5 4 3 2 1

10 9 8 7 6 5 4 3 2 1

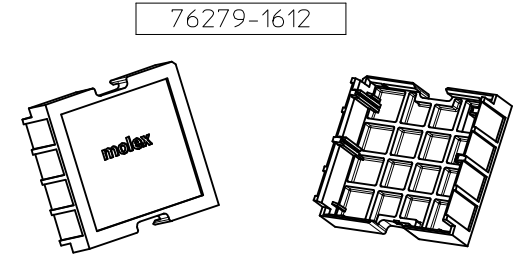
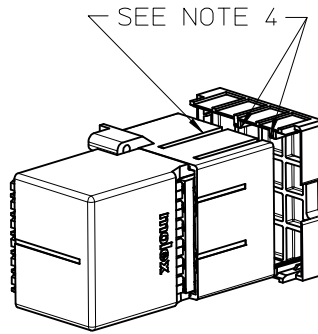
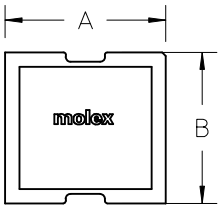
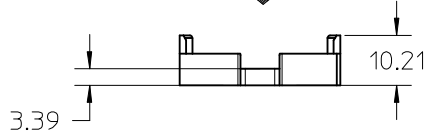
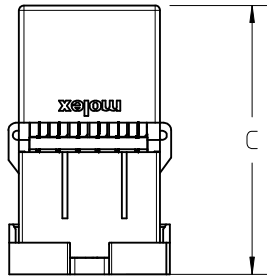
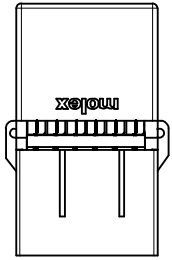

76279-1510

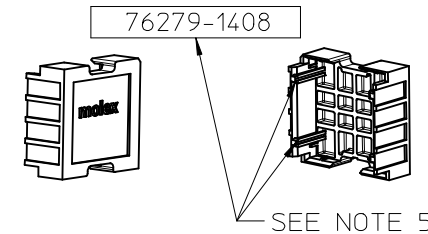
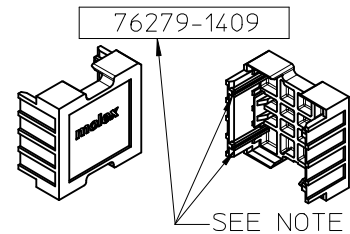
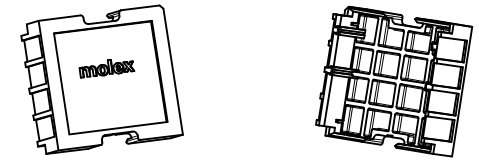

NOTES:

- MATERIAL: ABS
COLOR: NATURAL (WHITE)
- COVERS FIT BOTH GUIDED AND UNGUIDED CONFIGURATIONS.
- THIS PART CONFORMS TO CLASS B REQUIREMENTS OF COSMETIC SPEC PS-45499-002
- INTERNAL COVER RIBS ALIGN WITH SLOTS ON CONNECTOR HOUSING
- ONLY MATES WITH TWO SLOT 4 PAIR OD-RAM
- PLEASE SEE RAS-76279-9999 FOR DUST COVER USAGE AND REAPPLICATION GUIDELINES.

PART NUMBER	NUMBER OF PAIRS	NUMBER OF COLUMNS	DIM "A"	DIM "B"	DIM "C"
76279-1612	6 PAIR	12 COLUMN	32.9	30.9	55
76279-1510	5 PAIR	10 COLUMN	27.9	26.9	50
76279-1408	4 PAIR	8 COLUMN	23.8	22.8	46
76279-1409	4 PAIR/TOP GUIDE	8 COLUMN			

ADD 76279-1409 EC NO: UCP2015-3274 DRWN:BJ MILLER 2015/01/12 CHKD: APPR:TELO 2015/02/12 REV A	QUALITY SYMBOLS ▽/0 ▽/0 ▽/0	GENERAL TOLERANCES (UNLESS SPECIFIED) mm INCH 4 PLACES ± --- ± --- 3 PLACES ± --- ± --- 2 PLACES ± 0.13 ± --- 1 PLACE ± 0.25 ± --- 0 PLACE ± --- ± --- ANGULAR ± 1/2° DRAFT WHERE APPLICABLE MUST REMAIN WITHIN DIMENSIONS	DIMENSION STYLE MM ONLY DRAWN BY DATE BJ MILLER 2013/08/09 CHECKED BY DATE APPROVED BY DATE TELO 2015/02/12	SCALE 1:1 DESIGN UNITS METRIC THIRD ANGLE PROJECTION	TITLE IMPACT ORTHOGONAL DIRECT PROTECTIVE DUST COVERS molex	MATERIAL NO. SEE CHART	DOCUMENT NO. SD-76279-1612	SHEET NO. 1 OF 1
	THIS DRAWING CONTAINS INFORMATION THAT IS PROPRIETARY TO MOLEX INCORPORATED AND SHOULD NOT BE USED WITHOUT WRITTEN PERMISSION							

9 8 7 6 5 4 3 2 1