

DRV11873 12-V, 3-Phase, Sensorless BLDC Motor Driver

1 Features

- Input Voltage Range: 5 to 16 V
- Six Integrated MOSFETs With 1.5-A Continuous Output Current
- Total Driver H + L $R_{\text{DS(ON)}}$ 450 m Ω
- Sensorless Proprietary BMEF Control Scheme
- 150° Commutation
- Synchronous Rectification PWM Operation
- FG and RD Open-Drain Output
- 5-V LDO for External Use up to 20 mA
- PWM_{IN} Input from 7 to 100 kHz
- Overcurrent Protection With Adjustable Limit Through External Resistor
- Lock Detection
- Voltage Surge Protection
- UVLO
- Thermal Shutdown

2 Applications

- Appliance Cooling Fan
- Desktop Cooling Fan
- Server Cooling Fan

4 Simplified Schematic

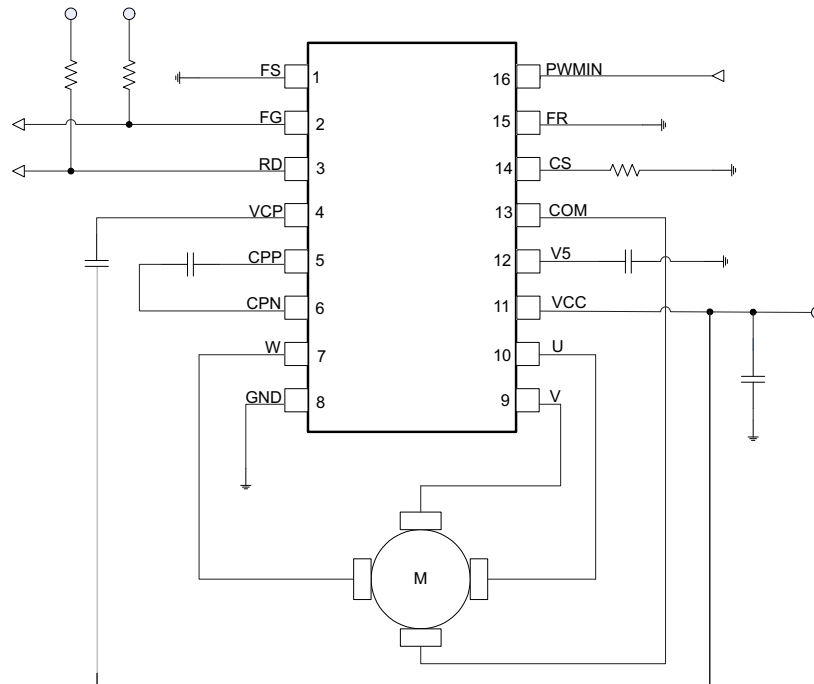

3 Description

DRV11873 is a three-phase, sensorless motor driver with integrated power MOSFETs with drive current capability up to 1.5-A continuous and 2-A peak. DRV11873 is specifically designed for fan motor drive applications with low noise and low external component count. DRV11873 has built-in overcurrent protection with no external current sense resistor needed. The synchronous rectification mode of operation achieves increased efficiency for motor driver applications. DRV11873 outputs FG and RD to indicate motor status with open-drain output. A 150° sensorless BEMF control scheme is implemented for a three-phase motor. DRV11873 is available in the thermally-efficient 16-pin TSSOP package. The operation temperature is specified from -40°C to 125°C.

Device Information⁽¹⁾

PART NUMBER	PACKAGE	BODY SIZE (NOM)
DRV11873	HTSSOP (16)	4.40 mm x 5.00 mm

(1) For all available packages, see the orderable addendum at the end of the data sheet.



Table of Contents

1 Features	1	8.2 Functional Block Diagram	9
2 Applications	1	8.3 Feature Description	10
3 Description	1	8.4 Device Functional Modes	11
4 Simplified Schematic	1	9 Application and Implementation	13
5 Revision History	2	9.1 Application Information	13
6 Pin Configuration and Functions	3	9.2 Typical Application	13
7 Specifications	4	10 Power Supply Recommendations	15
7.1 Absolute Maximum Ratings	4	11 Layout	15
7.2 Handling Ratings	4	11.1 Layout Guidelines	15
7.3 Recommended Operating Conditions	4	11.2 Layout Example	15
7.4 Thermal Information	5	12 Device and Documentation Support	16
7.5 Electrical Characteristics	6	12.1 Trademarks	16
7.6 Typical Characteristics	7	12.2 Electrostatic Discharge Caution	16
8 Detailed Description	9	12.3 Glossary	16
8.1 Overview	9	13 Mechanical, Packaging, and Orderable Information	16

5 Revision History

Changes from Original (November 2012) to Revision A

Page

- Added *Handling Ratings* table, *Feature Description* section, *Device Functional Modes*, *Application and Implementation* section, *Power Supply Recommendations* section, *Layout* section, *Device and Documentation Support* section, and *Mechanical, Packaging, and Orderable Information* section
- Changed f_{PWM} minimum value

6 Pin Configuration and Functions

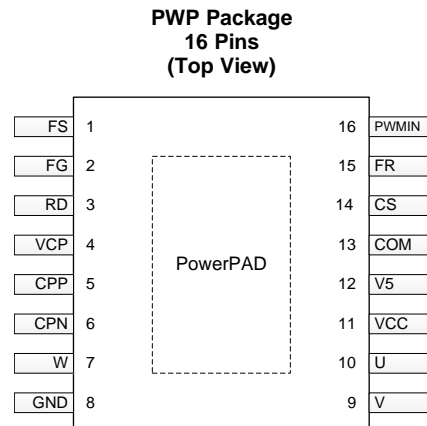

Pin Functions

PIN		I/O ⁽¹⁾	DESCRIPTION
NAME	NO.		
FS	1	I	Motor parameter adjustment pin. Pull low for lower-speed motor and pull high for high-speed motor.
FG	2	O	Frequency generator output. The output period is equal to 6 electrical states (FG).
RD	3	O	In the lock condition, RD output is high through a pullup resistor to V _{CC} or 5 V.
VCP	4	O	Charge pump output
CPP	5	O	Charge pump conversion terminal
CPN	6	O	Charge pump conversion terminal
W	7	O	Phase W output
GND	8	—	Ground pin
V	9	O	Phase V output
U	10	O	Phase U output
VCC	11	I	Input voltage for motor and chip supply voltage
V5	12	O	5-V regulator output
COM	13	I	Motor common terminal input. If the motor does not have a common wire, see Application and Implementation for more details.
CS	14	I	Overcurrent threshold set-up pin. A resistor set-up current limit is connected between this pin and ground. The voltage across the resistor compares with the voltage converted from the bottom MOSFETs' current. If MOSFETs' current is high, the part goes into the overcurrent protection mode by turning off the top PWM MOSFET and keeping the bottom MOSFET on. $I_{limit}(A) = 6600 / R_{CS} (\Omega)$; Equation valid range: 500 mA < I _{limit} < 2000 mA
FR	15	I	Set high for reverse rotation. Set low or floating for forward rotation.
PWMIN	16	I	PWM input pin. The PWM input signal is converted to a fixed switching frequency on the MOSFET driver.

(1) I = input, O = output, N/A = not available

7 Specifications

7.1 Absolute Maximum Ratings

over operating free-air temperature (unless otherwise noted)

		MIN	MAX	UNIT
Input voltage ⁽¹⁾	VCC	-0.3	20	V
	CS	-0.3	3.6	
	PWMIN, FS, FR	-0.3	6	
	GND	-0.3	0.3	
	COM	-1	20	
Output voltage ⁽¹⁾	U, V, W	-1	20	V
	FG, RD	-0.3	20	
	VCP	-0.3	25	
	CPN	-0.3	20	
	CPP	-0.3	25	
	V5	-0.3	6	
T _J	Operating junction temperature	-40	125	°C

(1) Voltage values are with respect to the network ground terminal unless otherwise noted.

7.2 Handling Ratings

		MIN	MAX	UNIT	
T _{stg}	Storage temperature range	-55	150	°C	
V _(ESD)	Electrostatic discharge	Human body model (HBM), per ANSI/ESDA/JEDEC JS-001, all pins ⁽¹⁾	-4000	4000	V
		Charged device model (CDM), per JEDEC specification JESD22-C101, all pins ⁽²⁾	-1000	1000	
		Machine model (MM)	-200	200	

(1) JEDEC document JEP155 states that 500-V HBM allows safe manufacturing with a standard ESD control process.

(2) JEDEC document JEP157 states that 250-V CDM allows safe manufacturing with a standard ESD control process.

7.3 Recommended Operating Conditions

over operating free-air temperature range (unless otherwise noted)

		MIN	MAX	UNIT
Supply voltage	VCC	5	16	V
Voltage range	U, V, W	-0.7	17	V
	COM	-0.1	17	
	FG, RD	-0.1	16	
	PGND, GND	-0.1	0.1	
	VCP	-0.1	22	
	CPP	-0.1	22	
	CPN	-0.1	16	
	V5	-0.1	5.5	
	PWMIN, FR, FS	-0.1	5.5	
T _J	Operating junction temperature	-40	125	V

7.4 Thermal Information

THERMAL METRIC ⁽¹⁾		DRV11873	UNIT
		PWP	
		16 PINS	
$R_{\theta JA}$	Junction-to-ambient thermal resistance	39.4	°C/W
$R_{\theta JC(top)}$	Junction-to-case (top) thermal resistance	30.3	
$R_{\theta JB}$	Junction-to-board thermal resistance	25.6	
Ψ_{JT}	Junction-to-top characterization parameter	0.5	
Ψ_{JB}	Junction-to-board characterization parameter	10.2	
$R_{\theta JC(bot)}$	Junction-to-case (bottom) thermal resistance	3.6	

(1) For more information about traditional and new thermal metrics, see the *IC Package Thermal Metrics* application report, [SPRA953](#).

7.5 Electrical Characteristics

over recommended operating free-air temperature (unless otherwise noted)

PARAMETER		TEST CONDITIONS	MIN	TYP	MAX	UNIT
SUPPLY CURRENT						
I_{VCC}	Supply current	$T_A = 25^\circ\text{C}$; PWM = V_{CC} ; $V_{CC} = 12\text{ V}$		2.7	5	mA
UVLO						
$V_{UVLO-th_r}$	UVLO threshold voltage	Rise threshold, $T_A = 25^\circ\text{C}$		4.3	4.6	V
$V_{UVLO-th_f}$	UVLO threshold voltage	Fall threshold, $T_A = 25^\circ\text{C}$	3.9	4.1		V
$V_{UVLO-thhys}$	UVLO threshold voltage hysteresis	$T_A = 25^\circ\text{C}$	100	200	300	mV
INTEGRATED MOSFET						
$R_{DS(on)}$	Series resistance (H + L)	$T_A = 25^\circ\text{C}$; $V_{CC} = 12\text{ V}$; $V_{CP} = 19\text{ V}$; $I_{OUT} = 1.5\text{ A}$		0.45	0.6	Ω
PWM						
V_{PWM-IH}	High-level input voltage	$V_{CC} \geq 4.5\text{ V}$	2.7			V
V_{PWM-IL}	Low-level input voltage	$V_{CC} \geq 4.5\text{ V}$			0.8	V
f_{PWM}	PWM input frequency		7		100	kHz
$I_{PWM-SOURCE}$	PWM source current		35	50	65	μA
FG						
$I_{FG-SINK}$	FG pin sink current	$V_{FG} = 0.3\text{ V}$	5			mA
$I_{FG-short}$	FG pin short current limit	$V_{FG} = 12\text{ V}$		20	25	mA
RD						
$I_{RD-SINK}$	RD pin sink current	$V_{RD} = 0.3\text{ V}$	5			mA
$I_{RD-short}$	RD pin short current limit	$V_{RD} = 12\text{ V}$		20	25	mA
FR and FS						
V_{FR-IH}	High-level input voltage	$V_{CC} \geq 4.5\text{ V}$	2.3			V
V_{FR-IL}	Low-level input voltage	$V_{CC} \geq 4.5\text{ V}$			0.8	V
V_{FS-th}	FS set threshold voltage	$V_{CC} \geq 4.5\text{ V}$	2.3		0.8	V
V5						
V5	5-V LDO voltage	$V_{CC} = 12\text{ V}$	4.75	5	5.25	V
I_{V5}	5-V LDO load current	$V_{CC} = 12\text{ V}$		20		mA
LOCK PROTECTION						
$t_{LOCK-ON}$	Lock detect time	FS = 0	0.875	1.25	1.625	s
		FS = 1	0.437	0.625	0.812	
$t_{LOCK-OFF}$	Lock release time	FS = 0	4.375	6.25	8.125	s
		FS = 1	2.187	3.125	4.06	
CURRENT LIMIT						
	Current limit	CS pin to GND resistor = 3.3 k Ω	1.7	2	2.3	A
THERMAL SHUTDOWN						
T_{SDN}	Shutdown temperature threshold	Shutdown temperature		160		$^\circ\text{C}$
		Hysteresis		10		

7.6 Typical Characteristics

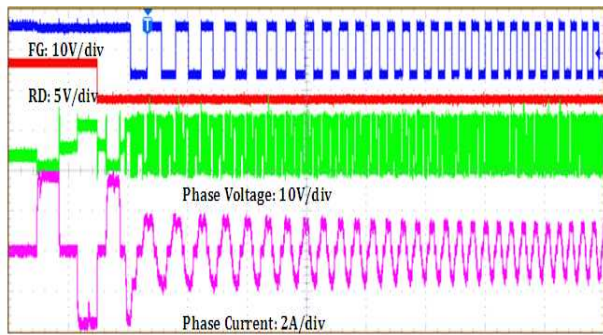

Input voltage = 12 V PWM duty = 100% FS = 1
t = 20 ms/div

Figure 1. Start Up at 100% Duty

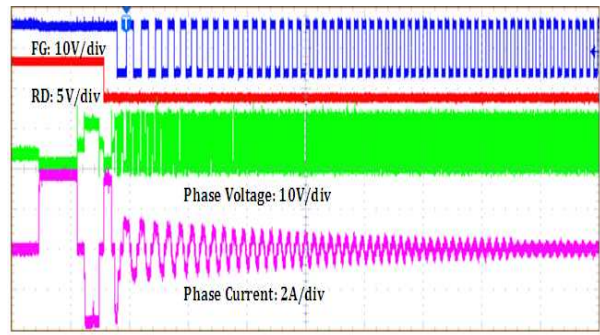

Input voltage = 12 V PWM duty = 10% FS = 1
t = 40 ms/div

Figure 2. Start Up at 10% Duty

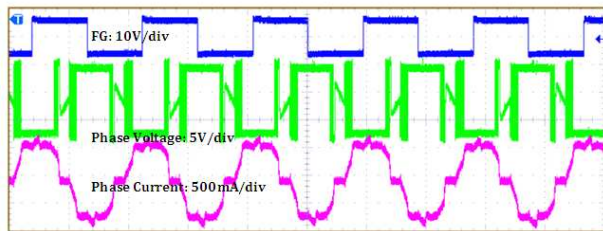

Input voltage = 12 V PWM duty = 100% FS = 1
t = 800 μs/div

Figure 3. Normal Operation at 100% Duty

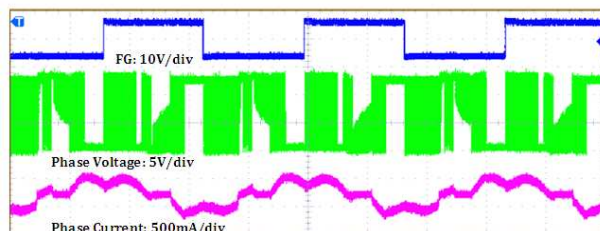

Input voltage = 12 V PWM duty = 50% FS = 1
t = 800 μs/div

Figure 4. Normal Operation at 50% Duty

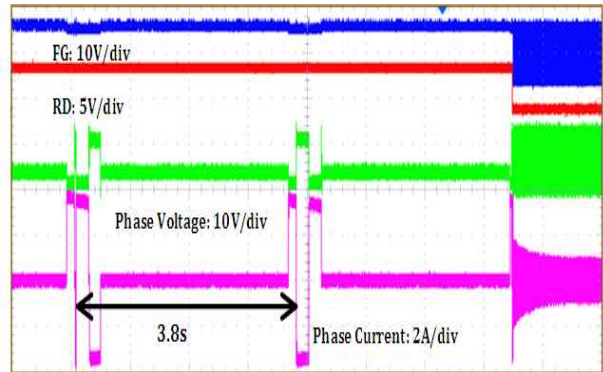

Input voltage = 12 V PWM duty = 100% FS = 1
t = 1 s/div

Figure 5. Lock Protection

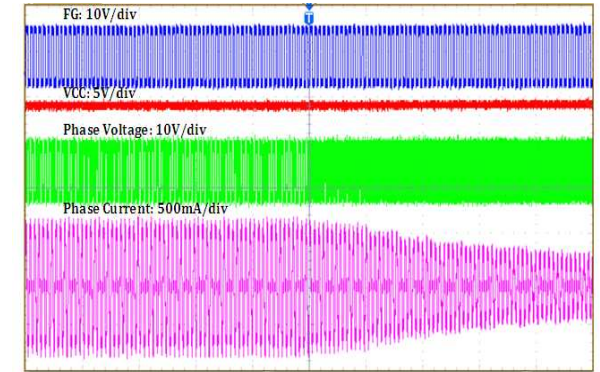

Input voltage = 12 V PWM duty switch from 100% to 20% FS = 1
t = 20 ms/div

Figure 6. AVS Operation

Typical Characteristics (continued)

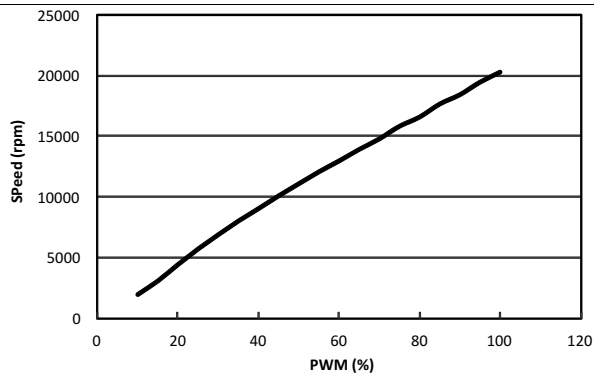

Figure 7. Fast Motor RPM vs Duty, FS = 1

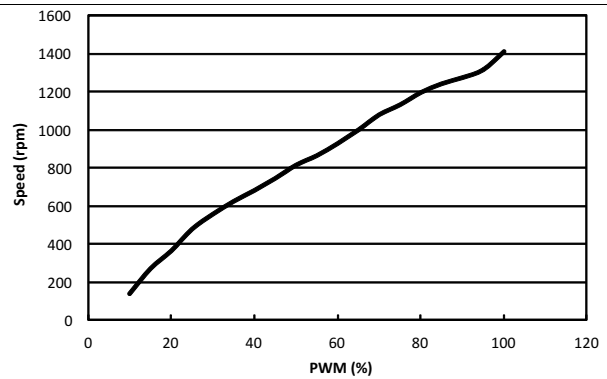

Figure 8. Slow Motor RPM vs Duty, FS = 0

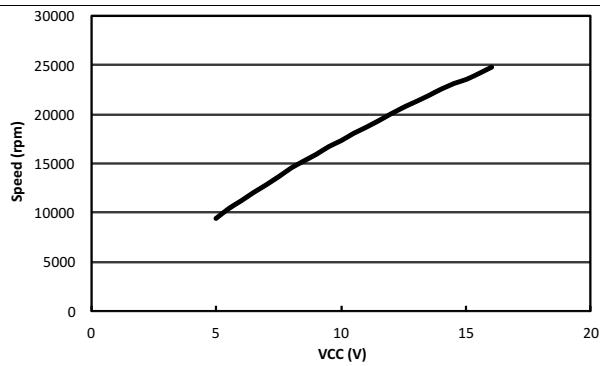

Figure 9. Fast Motor RPM vs Voltage, FS = 1

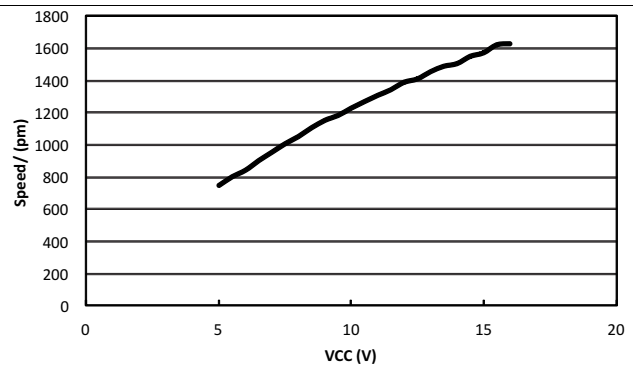

Figure 10. Slow Motor RPM vs Voltage, FS = 0

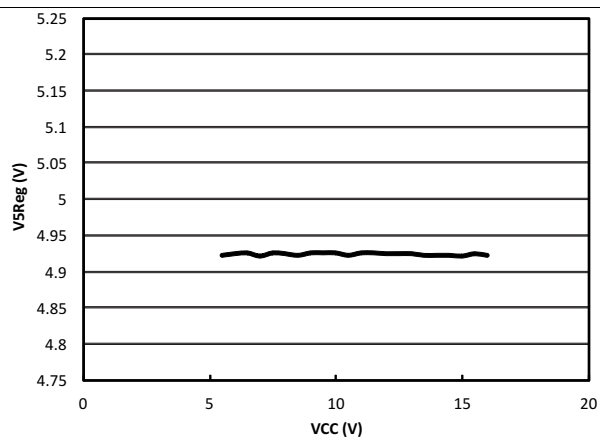

Figure 11. 5-V LDO Line Regulation

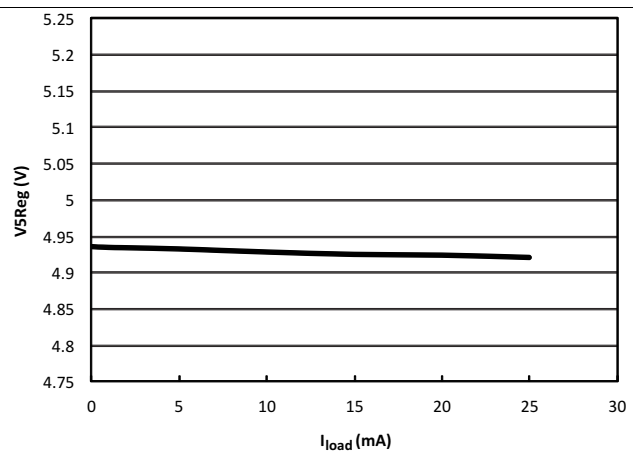

Figure 12. 5-V LDO Load Regulation

8.3 Feature Description

8.3.1 Speed Control

DRV11873 can control motor speed through either the PWM_{IN} or V_{CC} pin. Motor speed increases with higher PWM_{IN} duty cycle or V_{CC} input voltage. The curve of motor speed (RPM) vs PWM_{IN} duty cycle or V_{CC} input voltage is close to linear in most cases. However, motor characteristics affect the linearity of this speed curve. DRV11873 can operate at low V_{CC} input voltage ≥ 4.1 V. The PWM_{IN} pin is pulled up to V5 internally and the frequency range can vary from 7 to 100 kHz. The motor driver MOSFETs operate at a constant switching frequency of 125 kHz when the FS pin is pulled high and 62.5 kHz when the FS pin is pulled low. With this high switching frequency, DRV11873 can eliminate audible noise and reduce the ripple of V_{CC} input voltage and current.

8.3.2 Frequency Generator

The FG output is a 50% duty square wave output in the normal operation condition. Its frequency represents the motor speed and phase information. The FG pin is an open-drain output. An external pullup resistor is needed to connect any external system. During the start up, the FG output remains at high impedance until the motor speed reaches a certain level and BEMF is detected. If FG is not used, this pin can be left floating. The FG pin can be tied to either V5 or V_{CC} through a pullup resistor. Normally, the pullup resistor value can be 100 kΩ or higher. During lock protection, the FG output remains high until the lockout protection is dismissed and restart is completed. A current limit function is built in for the FG pin which prevents the open-drain MOSFET from damage if V_{CC} or V5 is accidentally connected to the FG pin. To calculate RPM based on FG frequency, refer to [Equation 1](#).

$$\text{RPM} = \frac{(\text{FG} \times 60)}{\text{pole pairs}}$$

where

- FG is in hertz (Hz)

(1)

8.3.3 FS Setting

DRV11873 can fit a wide range of fan motors by setting the FS pin. For high speed fan motors with low motor winding resistance and low inductance, the FS pin should be pulled high. For low speed fan motors with high motor winding resistance and high inductance, the FS pin should be pulled low. Through FS pin selection, DRV11873 can be used for wide applications from low-speed refrigerator cooling fans to high-speed server cooling fans. FS status can only be set during device power up.

8.3.4 Lock Protection and RD Output

If the motor is blocked or stopped by an external force, the lock protection will be triggered after detection time. During lock detection time, the circuit monitors the FG signal. If the FG output does not change state during the lock detection time, the lock protection will stop driving the motor. After lock release time, DRV11873 resumes driving the motor. If the lock condition is still present, DRV11873 proceeds with the next lock protection cycle until the lock condition is removed. With this lock protection, the motor and device do not get overheated or damaged. A different FS setting determines a different lock detection and lock release time. See the [Electrical Characteristics](#) for the different lock detection and release times.

The RD pin is an open-drain output which can be tied to either V5 or V_{CC} through a pullup resistor. Normally, the pullup resistor value can be 100 kΩ or higher. During the lock protection condition, the RD output remains high until the lock protection is dismissed and restart is completed. A current limit function is built in for the RD pin which prevents the open-drain MOSFET from damage if V_{CC} or V5 is accidentally connected to the RD pin.

8.3.5 Reverse Spin Control FR

DRV11873 has an FR pin to set the motor for forward or reverse spin. During DRV11873 power up, FR status is set. During normal operation, the spin direction of the motor does not change if the FR status is changed. The FR status can be reset if the PWM_{IN} is pulled low; if FS is high, PWM must be pulled low for 300 μs, and if FS is low, PWM must be low for 600 μs. After being pulled down for the appropriate time, the FR status resets upon the PWM rising edge.

Feature Description (continued)

8.3.6 5-V LDO

DRV11873 has a built-in 5-V LDO which can output a 20-mA load current. It can provide 5-V bias voltage for external use. TI recommends a 2.2- μ F ceramic capacitor to connect closely on the PCB layout between the V5 pin and ground.

8.3.7 Overcurrent Protection

DRV11873 can adjust overcurrent through the external resistor connected to the CS pin and ground. Without using an external current sense resistor, DRV11873 senses the current through the power MOSFET. Therefore, no power loss occurs during the current sensing. This current sense architecture improves the system efficiency. Shorting the CS pin to ground disables overcurrent protection. During overcurrent protection, DRV11873 only limits the current to the motor and it does not shut down the operation. The overcurrent threshold can be set by the value of the external resistor through [Equation 2](#).

$$I \text{ (A)} = \frac{6600}{R_{CS} \text{ (\Omega)}} \quad (2)$$

During motor start up, the overcurrent level is increased to 1.5 times the value set by R_{CS} . If the overcurrent protection is triggered during the start up sequence, the motor will fail to start.

8.3.8 UVLO

DRV11873 has a built-in UVLO function block. The hysteresis of the UVLO threshold is 200 mV. The device is locked out when V_{CC} reaches 4.1 V and woken up at 4.3 V.

8.3.9 Thermal Shutdown

DRV11873 has a built-in thermal shutdown function, which shuts down the device when the junction temperature is over 160°C and resumes operating when the junction temperature drops back to 150°C.

8.3.10 Anti-Voltage Surge (AVS)

The DRV11873 has a protection feature to prevent any energy from returning to the power supply when the motor is braked. This feature, AVS, protects the device as well as any other device from allowing V_{CC} from increasing. AVS works when the motor is braked to a lower speed and when the motor is stopped.

8.4 Device Functional Modes

8.4.1 Startup

At startup, commutation logic starts to drive the motor with one phase high, one phase low, and the third shut off. If a zero-cross is detected on the shut off phase, commutation logic advances to the next step; the same phase high, the shut off phase goes low, and the low phase is shut off. Initially, the BEMF is not strong enough to detect the zero crossings, at this very initial stage the commutation switches automatically until the BEMF is large enough to read. In startup mode, 100% duty cycle is applied regardless of PWM input. After the commutation logic receives 4 continuous successful zero-crossings, it switches to normal operation.

In certain cases, the motor may have initial speed when the device attempts to startup the motor again. When this occurs, the commutation logic jumps over the startup process and goes to normal operation directly.

8.4.2 Closed Loop Control

After the motor is started successfully, the start up control switches to steady state operation. In steady state control, the motor is commutated 150°. This is an advanced trapezoidal method that allows the device to drive the phases gradually to the maximum current and gradually to 0 at commutation.

Device Functional Modes (continued)

8.4.3 AVS Protection

When the device is commanded to decelerate or stop the motor, in order to protect the IC and the system, the DRV11873 has AVS protection. This function keeps the voltage supply, V_{CC} , from surging above the nominal value. To do this, the device monitors the current flow in the MOSFETs and is able to sense when the surging starts to occur. The AVS function controls the current, not allowing it to charge back to V_{CC} so that there is no voltage surging.

9 Application and Implementation

NOTE

Information in the following applications sections is not part of the TI component specification, and TI does not warrant its accuracy or completeness. TI's customers are responsible for determining suitability of components for their purposes. Customers should validate and test their design implementation to confirm system functionality.

9.1 Application Information

DRV11873 only requires five external components. The device needs a 10- μ F or higher ceramic capacitor connected to V_{CC} and ground for decoupling. During layout, the strategy of ground copper pour is very important to enhance the thermal performance. For two or more layers, use eight thermal vias. Refer to [Layout Example](#) for an example of the PCB layout. For high current motors, place three Schottky diodes between phases U, V, W, and ground. Each diode anode terminal must be connected to ground and the cathode terminal must be connected to either U, V, or W. If there is no COM pin on the motor, one can be simulated. Use three resistors connected in a wye formation, one connected to U, one to V, and one to W. Connect the resistor ends opposite of the phases together. This center point is COM. To find the proper resistor value, start with a value of 10 k Ω and continue to decrease by 1 k Ω until the motor runs properly.

9.2 Typical Application

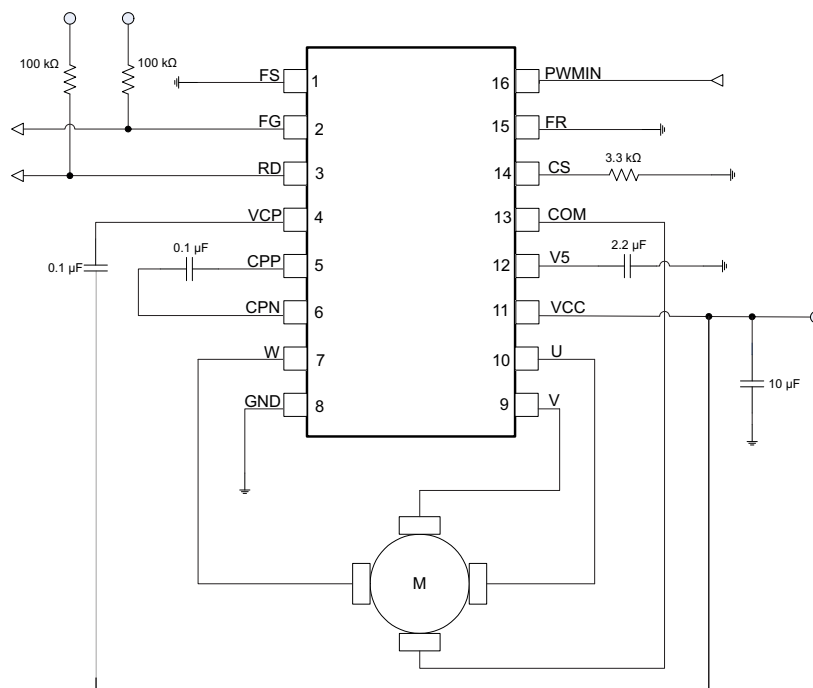

Figure 13. Typical Application Schematic

9.2.1 Design Requirements

Table 1. Design Parameters

		MIN	TYP	MAX	UNIT
Motor voltage		5		16	V
VCC capacitor	Place as close to the pin as possible		10		μ F
Operating current	Running with normal load at rated speed			1.5	A
Absolute max current	During startup and locked motor condition			2	A

10 Power Supply Recommendations

The DRV11873 is designed to operate from an input voltage supply, V_{CC} , range between 5 and 16 V. The user must place a 10- μ F ceramic capacitor rated for VCC as close as possible to the VCC and GND pin. If the power supply ripple is more than 200 mV, in addition to the local decoupling capacitors, a bulk capacitance is required and must be sized according to the application requirements. If the bulk capacitance is implemented in the application, the user can reduce the value of the local ceramic capacitor to 1 μ F.

11 Layout

11.1 Layout Guidelines

- Place VCC, GND, U, V, and W pins with thick traces because high current passes through these traces.
- Place the 10- μ F capacitor between VCC and GND, and as close to the VCC and GND pins as possible.
- Place the capacitor between CPP and CPN, and as close to the CPP and CPN pins as possible.
- Place the capacitor between V5 and GND as close to the V5 pin as possible.
- Connect the GND under the thermal pad.
- Keep the thermal pad connection as large as possible, both on the bottom side and top side. It should be one piece of copper without any gaps.

11.2 Layout Example

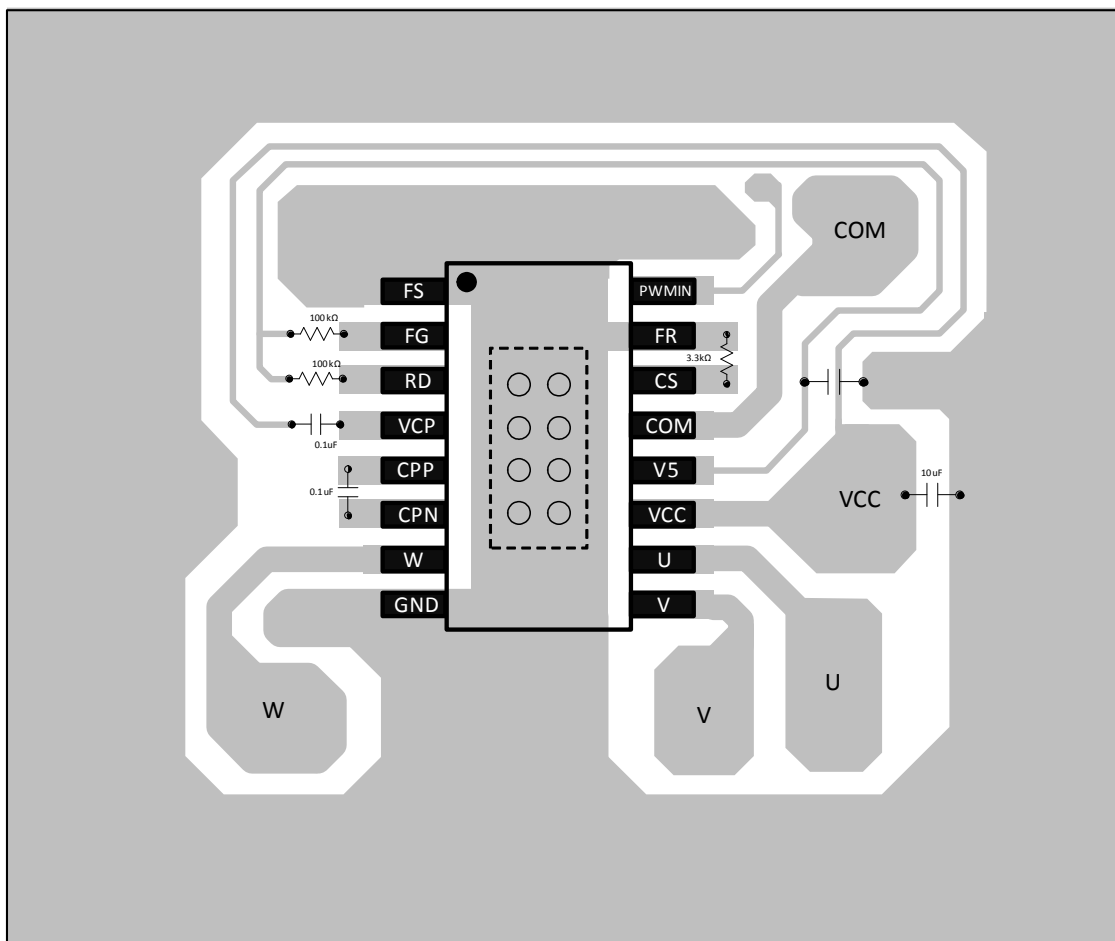

Figure 17. Layout Example Schematic

12 Device and Documentation Support

12.1 Trademarks

All trademarks are the property of their respective owners.

12.2 Electrostatic Discharge Caution



These devices have limited built-in ESD protection. The leads should be shorted together or the device placed in conductive foam during storage or handling to prevent electrostatic damage to the MOS gates.

12.3 Glossary

[SLYZ022](#) — *TI Glossary*.

This glossary lists and explains terms, acronyms, and definitions.

13 Mechanical, Packaging, and Orderable Information

The following pages include mechanical, packaging, and orderable information. This information is the most current data available for the designated devices. This data is subject to change without notice and revision of this document. For browser-based versions of this data sheet, refer to the left-hand navigation.

PACKAGING INFORMATION

Orderable Device	Status (1)	Package Type	Package Drawing	Pins	Package Qty	Eco Plan (2)	Lead finish/ Ball material (6)	MSL Peak Temp (3)	Op Temp (°C)	Device Marking (4/5)	Samples
DRV11873PWPR	ACTIVE	HTSSOP	PWP	16	2000	RoHS & Green	NIPDAU	Level-2-260C-1 YEAR	-40 to 85	11873	Samples

(1) The marketing status values are defined as follows:

ACTIVE: Product device recommended for new designs.

LIFEBUY: TI has announced that the device will be discontinued, and a lifetime-buy period is in effect.

NRND: Not recommended for new designs. Device is in production to support existing customers, but TI does not recommend using this part in a new design.

PREVIEW: Device has been announced but is not in production. Samples may or may not be available.

OBSOLETE: TI has discontinued the production of the device.

(2) **RoHS:** TI defines "RoHS" to mean semiconductor products that are compliant with the current EU RoHS requirements for all 10 RoHS substances, including the requirement that RoHS substance do not exceed 0.1% by weight in homogeneous materials. Where designed to be soldered at high temperatures, "RoHS" products are suitable for use in specified lead-free processes. TI may reference these types of products as "Pb-Free".

RoHS Exempt: TI defines "RoHS Exempt" to mean products that contain lead but are compliant with EU RoHS pursuant to a specific EU RoHS exemption.

Green: TI defines "Green" to mean the content of Chlorine (Cl) and Bromine (Br) based flame retardants meet JS709B low halogen requirements of <=1000ppm threshold. Antimony trioxide based flame retardants must also meet the <=1000ppm threshold requirement.

(3) MSL, Peak Temp. - The Moisture Sensitivity Level rating according to the JEDEC industry standard classifications, and peak solder temperature.

(4) There may be additional marking, which relates to the logo, the lot trace code information, or the environmental category on the device.

(5) Multiple Device Markings will be inside parentheses. Only one Device Marking contained in parentheses and separated by a "-" will appear on a device. If a line is indented then it is a continuation of the previous line and the two combined represent the entire Device Marking for that device.

(6) Lead finish/Ball material - Orderable Devices may have multiple material finish options. Finish options are separated by a vertical ruled line. Lead finish/Ball material values may wrap to two lines if the finish value exceeds the maximum column width.

Important Information and Disclaimer: The information provided on this page represents TI's knowledge and belief as of the date that it is provided. TI bases its knowledge and belief on information provided by third parties, and makes no representation or warranty as to the accuracy of such information. Efforts are underway to better integrate information from third parties. TI has taken and continues to take reasonable steps to provide representative and accurate information but may not have conducted destructive testing or chemical analysis on incoming materials and chemicals. TI and TI suppliers consider certain information to be proprietary, and thus CAS numbers and other limited information may not be available for release.

In no event shall TI's liability arising out of such information exceed the total purchase price of the TI part(s) at issue in this document sold by TI to Customer on an annual basis.

TAPE AND REEL INFORMATION



QUADRANT ASSIGNMENTS FOR PIN 1 ORIENTATION IN TAPE



*All dimensions are nominal

Device	Package Type	Package Drawing	Pins	SPQ	Reel Diameter (mm)	Reel Width W1 (mm)	A0 (mm)	B0 (mm)	K0 (mm)	P1 (mm)	W (mm)	Pin1 Quadrant
DRV11873PWPR	HTSSOP	PWP	16	2000	330.0	12.4	6.9	5.6	1.6	8.0	12.0	Q1

TAPE AND REEL BOX DIMENSIONS



*All dimensions are nominal

Device	Package Type	Package Drawing	Pins	SPQ	Length (mm)	Width (mm)	Height (mm)
DRV11873PWPR	HTSSOP	PWP	16	2000	350.0	350.0	43.0

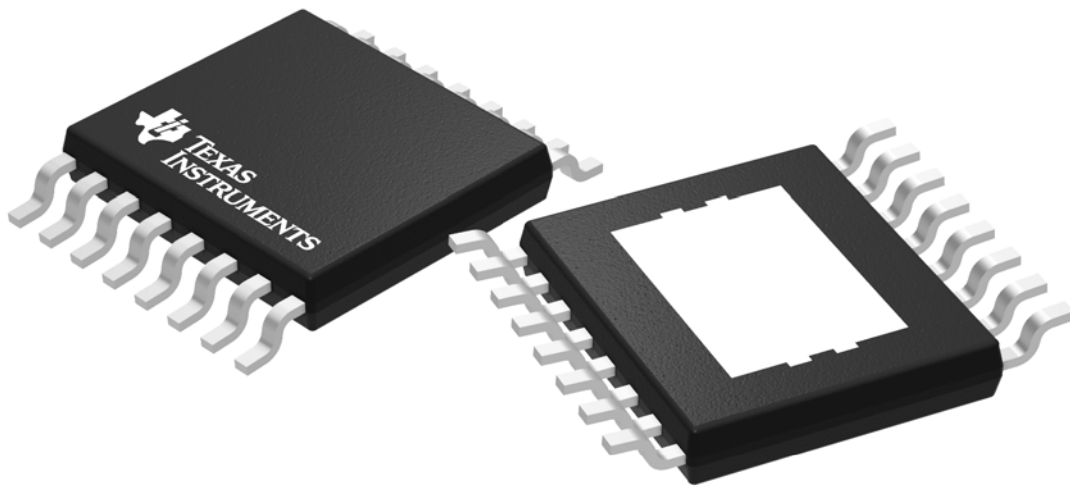

Images above are just a representation of the package family, actual package may vary.
Refer to the product data sheet for package details.

PWP0016C

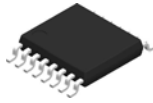

PACKAGE OUTLINE

PowerPAD™ TSSOP - 1.2 mm max height

SMALL OUTLINE PACKAGE

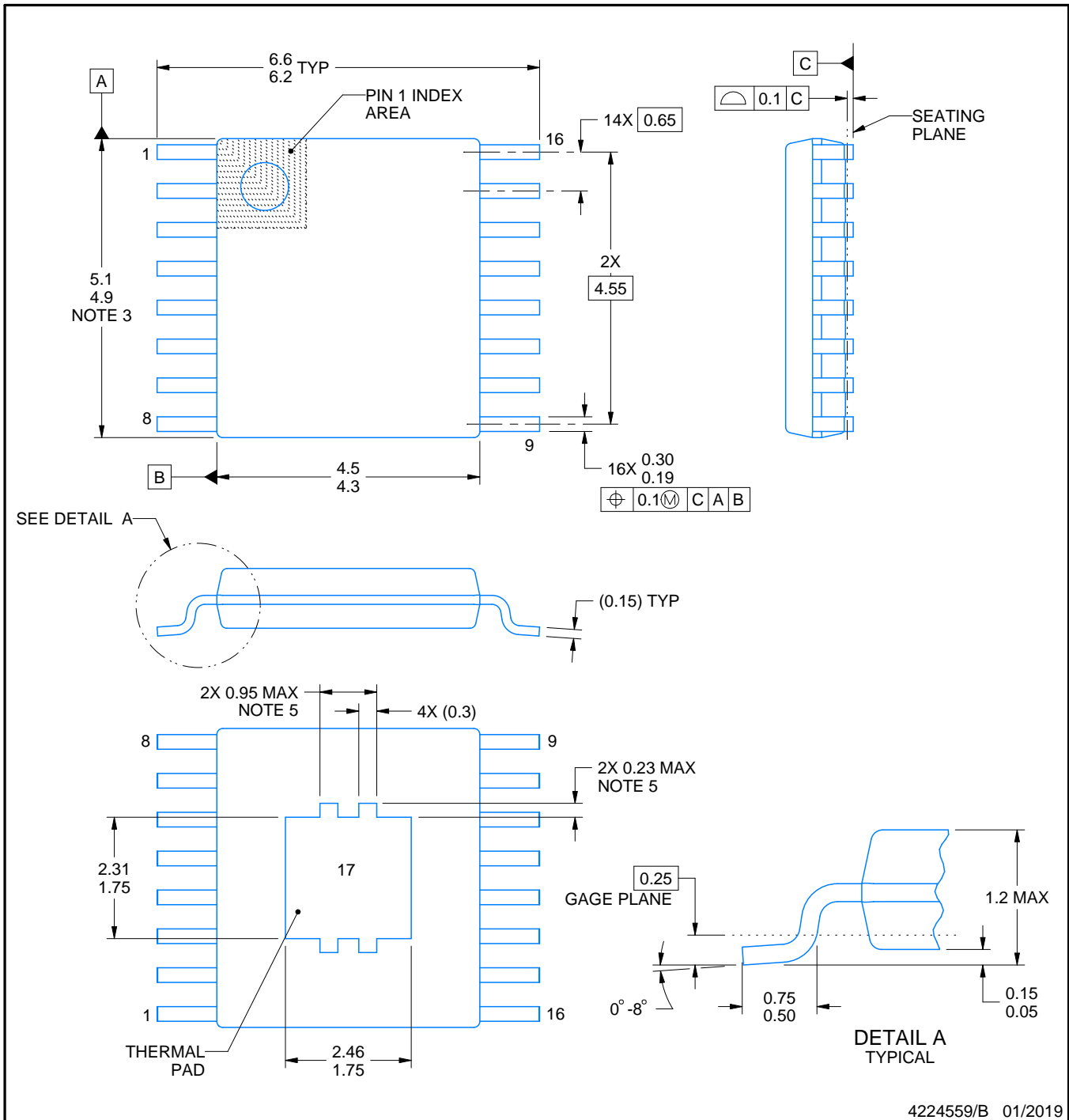

4224559/B 01/2019

NOTES:

PowerPAD is a trademark of Texas Instruments.

1. All linear dimensions are in millimeters. Any dimensions in parenthesis are for reference only. Dimensioning and tolerancing per ASME Y14.5M.
2. This drawing is subject to change without notice.
3. This dimension does not include mold flash, protrusions, or gate burrs. Mold flash, protrusions, or gate burrs shall not exceed 0.15 mm per side.
4. Reference JEDEC registration MO-153.
5. Features may differ or may not be present.

EXAMPLE STENCIL DESIGN

PWP0016C

PowerPAD™ TSSOP - 1.2 mm max height

SMALL OUTLINE PACKAGE

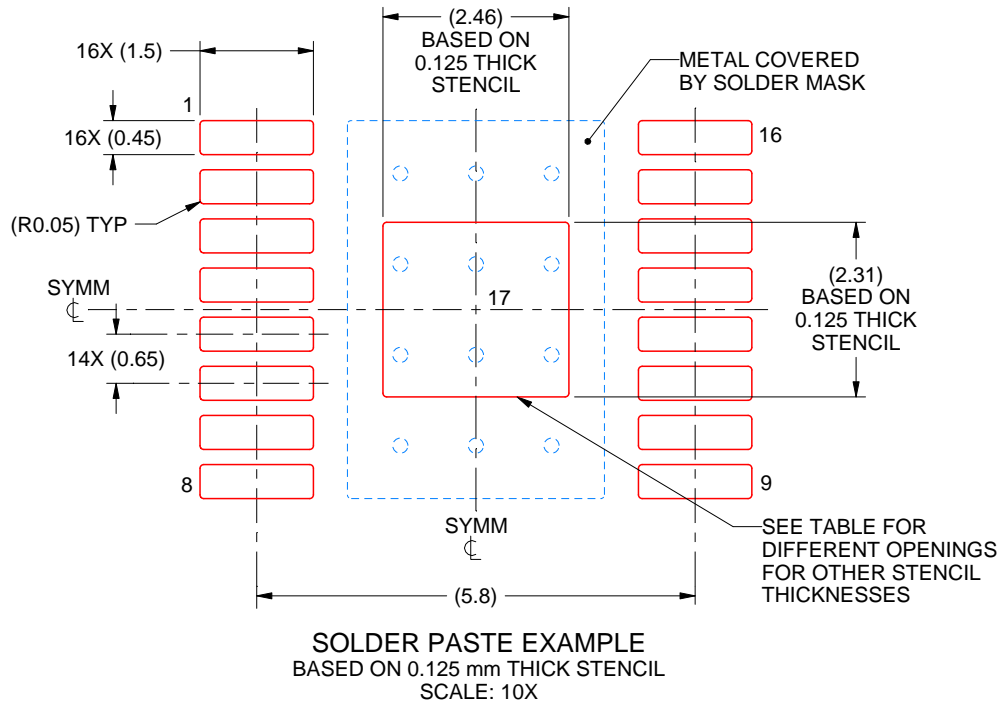

STENCIL THICKNESS	SOLDER STENCIL OPENING
0.1	2.75 X 2.58
0.125	2.46 X 2.31 (SHOWN)
0.15	2.25 X 2.11
0.175	2.08 X 1.95

4224559/B 01/2019

NOTES: (continued)

11. Laser cutting apertures with trapezoidal walls and rounded corners may offer better paste release. IPC-7525 may have alternate design recommendations.
12. Board assembly site may have different recommendations for stencil design.

IMPORTANT NOTICE AND DISCLAIMER

TI PROVIDES TECHNICAL AND RELIABILITY DATA (INCLUDING DATASHEETS), DESIGN RESOURCES (INCLUDING REFERENCE DESIGNS), APPLICATION OR OTHER DESIGN ADVICE, WEB TOOLS, SAFETY INFORMATION, AND OTHER RESOURCES "AS IS" AND WITH ALL FAULTS, AND DISCLAIMS ALL WARRANTIES, EXPRESS AND IMPLIED, INCLUDING WITHOUT LIMITATION ANY IMPLIED WARRANTIES OF MERCHANTABILITY, FITNESS FOR A PARTICULAR PURPOSE OR NON-INFRINGEMENT OF THIRD PARTY INTELLECTUAL PROPERTY RIGHTS.

These resources are intended for skilled developers designing with TI products. You are solely responsible for (1) selecting the appropriate TI products for your application, (2) designing, validating and testing your application, and (3) ensuring your application meets applicable standards, and any other safety, security, or other requirements. These resources are subject to change without notice. TI grants you permission to use these resources only for development of an application that uses the TI products described in the resource. Other reproduction and display of these resources is prohibited. No license is granted to any other TI intellectual property right or to any third party intellectual property right. TI disclaims responsibility for, and you will fully indemnify TI and its representatives against, any claims, damages, costs, losses, and liabilities arising out of your use of these resources.

TI's products are provided subject to TI's Terms of Sale (www.ti.com/legal/termsofsale.html) or other applicable terms available either on ti.com or provided in conjunction with such TI products. TI's provision of these resources does not expand or otherwise alter TI's applicable warranties or warranty disclaimers for TI products.

Mailing Address: Texas Instruments, Post Office Box 655303, Dallas, Texas 75265
Copyright © 2020, Texas Instruments Incorporated