

## STRADA-DW

Soft wide beam with good illuminance uniformity optimized for CREE XP-G and XP-E. Assembly with installation tape.

### SPECIFICATION:

Dimensions	19.6 x 15.5 mm
Height	9 mm
Fastening	tape, pin, screw
ROHS compliant	yes ⓘ



### MATERIALS:

Component	Type	Material	Colour	Finish
STRADA-DW	Single lens	PMMA	clear	
VOSU-WU-M-365-TAPE	Tape	Acrylic foam		





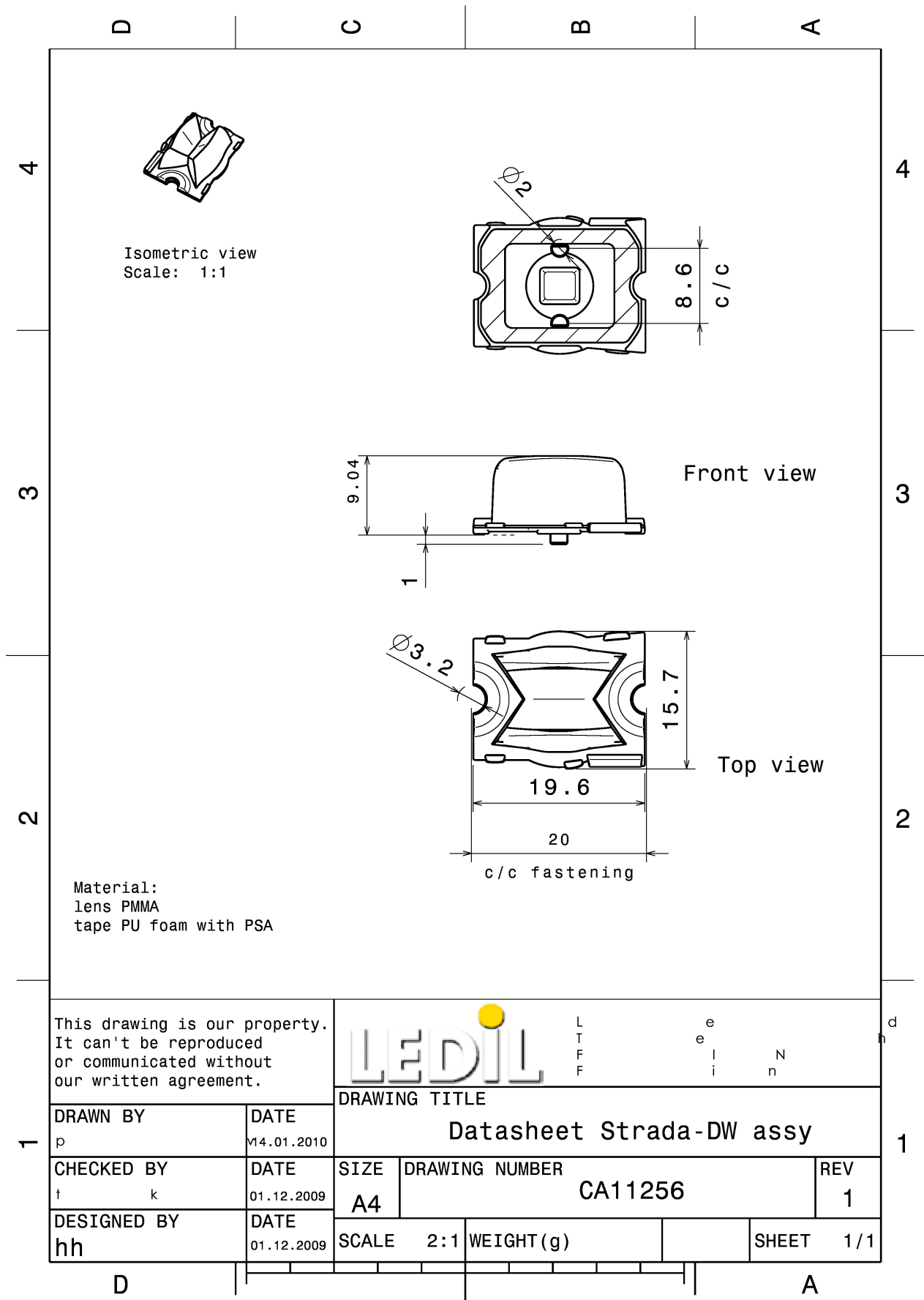

### ORDERING INFORMATION:

Component		Qty in box	MOQ	MPQ	Box weight (kg)
CA11256_STRADA-DW	Single lens	3120	240	240	4.3
» Box size: 451 x 273 x 197 mm					

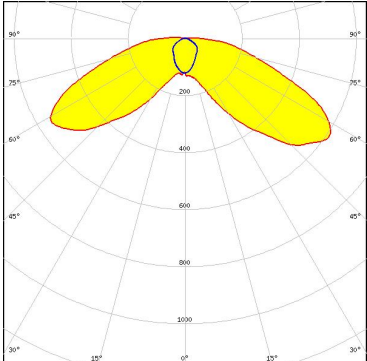

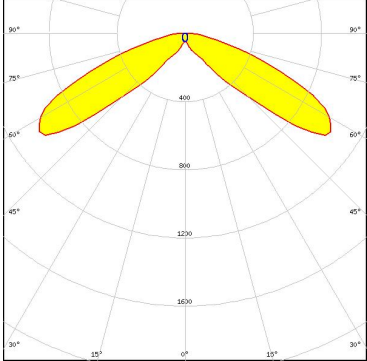
See also our general installation guide: [www.ledil.com/installation\\_guide](http://www.ledil.com/installation_guide)

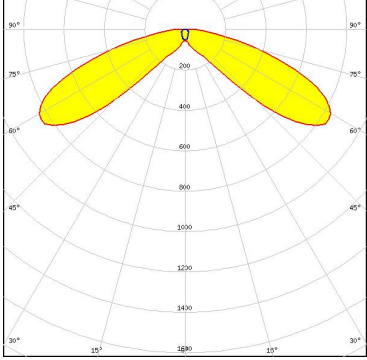
#### OPTICAL RESULTS (MEASURED):

<p> <b>bridgelux</b></p> <p>LED                    Bridgelux SMD 5050</p> <p>FWHM / FWTM        Asymmetric</p> <p>Efficiency            94 %</p> <p>Peak intensity        0.6 cd/lm</p> <p>LEDs/each optic     1</p> <p>Light colour         White</p> <p>Required components:</p>	
<p> <b>CREE LED</b></p> <p>LED                    XP-E</p> <p>FWHM / FWTM        90.0 + 140.0°</p> <p>Efficiency            92 %</p> <p>Peak intensity        1 cd/lm</p> <p>LEDs/each optic     1</p> <p>Light colour         White</p> <p>Required components:</p>	
<p> <b>CREE LED</b></p> <p>LED                    XP-G</p> <p>FWHM / FWTM        88.0 + 148.0°</p> <p>Efficiency            92 %</p> <p>Peak intensity        0.8 cd/lm</p> <p>LEDs/each optic     1</p> <p>Light colour         White</p> <p>Required components:</p>	
<p> <b>LUMILEDS</b></p> <p>LED                    LUXEON A</p> <p>FWHM / FWTM        86.0 + 140.0°</p> <p>Efficiency            92 %</p> <p>LEDs/each optic     1</p> <p>Light colour         White</p> <p>Required components:</p>	

#### OPTICAL RESULTS (MEASURED):

##### LUMILEDS

LED LUXEON Rebel  
 FWHM / FWTM 86.0 + 140.0°  
 Efficiency 92 %  
 Peak intensity 1 cd/m  
 LEDs/each optic 1  
 Light colour White  
 Required components:

##### LUMILEDS

LED LUXEON Rebel ES  
 FWHM / FWTM 86.0 + 140.0°  
 Efficiency 92 %  
 LEDs/each optic 1  
 Light colour White  
 Required components:

##### LUMILEDS

LED LUXEON T  
 FWHM / FWTM 86.0 + 144.0°  
 Efficiency 93 %  
 Peak intensity 0.9 cd/m  
 LEDs/each optic 1  
 Light colour White  
 Required components:

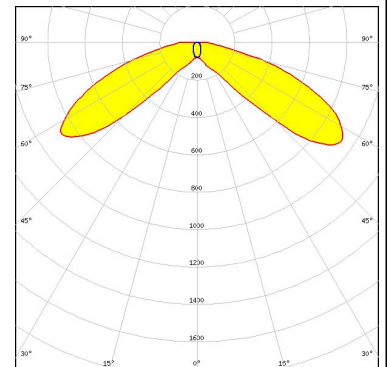

##### LUMILEDS

LED LUXEON TX  
 FWHM / FWTM 54.0 + 144.0° / 162.0 + 174.0°  
 Efficiency 94 %  
 Peak intensity 1 cd/m  
 LEDs/each optic 1  
 Light colour White  
 Required components:

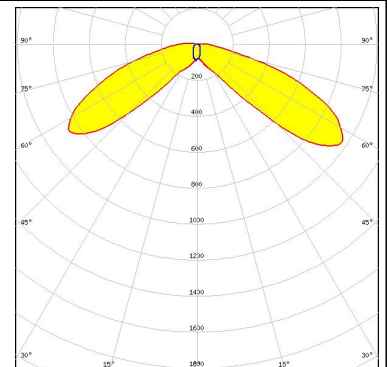

### OPTICAL RESULTS (MEASURED):



LED NCSxx19A  
FWHM / FWTM 86.0 + 148.0°  
Efficiency 92 %  
LEDs/each optic 1  
Light colour White  
Required components:



LED NVSW219D  
FWHM / FWTM 141.0 + 57.0° / 176.0 + 149.0°  
Efficiency 94 %  
Peak intensity 0.9 cd/lm  
LEDs/each optic 1  
Light colour White  
Required components:

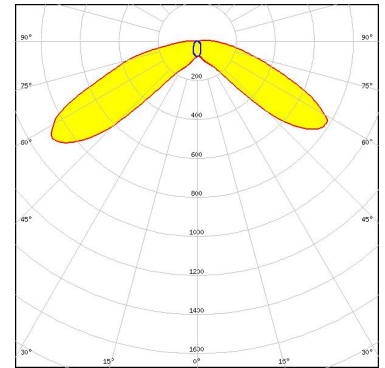

LED NVSxx19A  
FWHM / FWTM 86.0 + 148.0°  
Efficiency 92 %  
LEDs/each optic 1  
Light colour White  
Required components:



LED OSLOM SSL 150  
FWHM / FWTM 92.0 + 142.0°  
Efficiency 92 %  
LEDs/each optic 1  
Light colour White  
Required components:

### OPTICAL RESULTS (MEASURED):

#### OSRAM

Opto Semiconductors

LED OSLON SSL 80  
FWHM / FWTM 92.0 + 142.0°  
Efficiency 92 %  
Peak intensity 1 cd/lm  
LEDs/each optic 1  
Light colour White  
Required components:

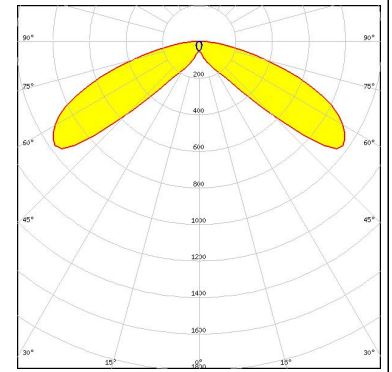

### OPTICAL RESULTS (SIMULATED):



LED XP-E2  
 FWHM / FWTM 87.0 + 135.0° / 54.0 + 156.0°  
 Efficiency 94 %  
 Peak intensity 1.5 cd/lm  
 LEDs/each optic 1  
 Light colour White  
 Required components:

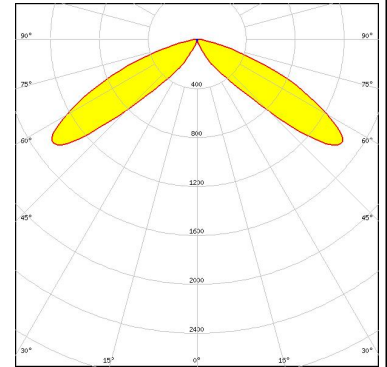

LED LUXEON H50-2  
 FWHM / FWTM 80.0 + 136.0° / 38.0 + 160.0°  
 Efficiency 93 %  
 Peak intensity 1.1 cd/lm  
 LEDs/each optic 1  
 Light colour White  
 Required components:

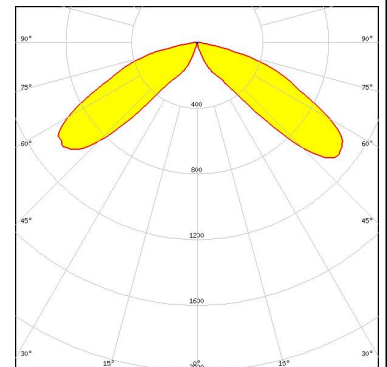

LED NVSxx19B/NVSxx19C  
 FWHM / FWTM 80.0 + 140.0°  
 Efficiency 94 %  
 Peak intensity 1 cd/lm  
 LEDs/each optic 1  
 Light colour White  
 Required components:

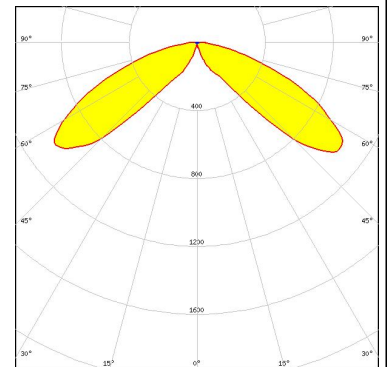

LED LH351B  
 FWHM / FWTM Asymmetric  
 Efficiency 96 %  
 Peak intensity 1.1 cd/lm  
 LEDs/each optic 1  
 Light colour White  
 Required components:

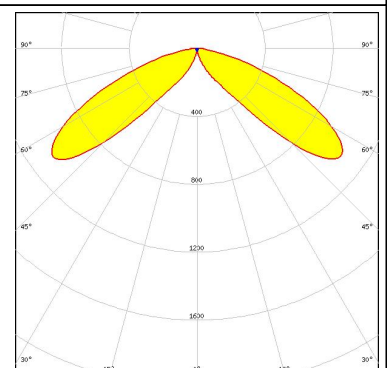

## OPTICAL RESULTS (SIMULATED):

 SEOL SEMICONDUCTOR	
LED	Z5
FWHM / FWTM	86.0 + 141.0°
Efficiency	%
LEDs/each optic	1
Light colour	White
Required components:	
<b>SHARP</b>	
LED	Double Dome (GM2BB)
FWHM / FWTM	86.0 + 141.0°
Efficiency	%
LEDs/each optic	1
Light colour	White
Required components:	



### GENERAL INFORMATION:

NOTE: The typical beam angle will be changed by different color, chip size and chip position tolerance. The typical total beam angle is the full angle measured where the luminous intensity is half of the peak value.

### MATERIALS:

As part of our continuous research and improvement processes, and to ensure the best possible quality and availability of our products, LEDiL reserves the right to change material grades without notice.

### PRODUCT DATA USER AGREEMENT AND DISCLAIMER:

The measured data in the provided downloadable LEDiL Product Datasheets and Mechanical 2D-Drawings is rounded and provided as reference for planning. LEDiL Oy's optical specifications have been verified by conducting performance testing of the products in accordance with the company's quality system. The reported data are averaged results of multiple measurements with typical variation. LEDiL Oy reserves the right to without prior notification make changes and improvements to its products.

LEDiL Oy assumes neither warranty, nor guarantee nor any other liability of any kind for the contents and correctness of the provided data. The provided data has been generated with highest diligence but the provided data may in reality not represent the complete possible variation range of all intrinsic parameters. Therefore, in certain cases a deviation from the provided data could occur.

LEDiL Oy reserves the right to undertake technical changes of its products without further notification which could lead to changes in the provided data. LEDiL Oy assumes no liability of any kind for the possible deviation from any provided data or any other damage resulting from the usage of the provided data.

The user agrees to this disclaimer and user agreement with the download or usage of the provided files.

#### LEDiL Oy

Joensuunkatu 13  
FI-24240 SALO  
Finland

#### LEDiL Inc.

228 West Page Street  
Suite D  
Sycamore IL 60178  
USA

#### Ledil Optics Technology (Shenzhen) Co., Ltd.

# 405 , Block B  
Casic Motor Building  
Shenzhen 518057  
P.R.CHINA

#### Local sales and technical support

[www.ledil.com/  
where\\_to\\_buy](http://www.ledil.com/where_to_buy)

#### Shipping locations

Salo, Finland  
Hong Kong, China

#### Distribution Partners

[www.ledil.com/  
where\\_to\\_buy](http://www.ledil.com/where_to_buy)