

XFP-10GB-CW35-40-C

MSA and TAA 10GBase-CWDM XFP Transceiver (SMF, 1350nm, 40km, LC, DOM)

Features:

- INF-8077i Compliance
- Duplex LC Connector
- Single-mode Fiber
- Commercial Temperature 0 to 70 Celsius
- Hot Pluggable
- Metal with Lower EMI
- Excellent ESD Protection
- RoHS Compliant and Lead Free



Applications:

- 10x Gigabit Ethernet over CWDM
- 8x/10x Fibre Channel
- Access, Metro and Enterprise
- Mobile Fronthaul CPRI/OBSAI

Product Description

This MSA Compliant XFP transceiver provides 10GBase-CWDM throughput up to 40km over single-mode fiber (SMF) using a wavelength of 1350nm via an LC connector. It is built to MSA standards and is uniquely serialized and data-traffic and application tested to ensure that they will integrate into your network seamlessly. Digital optical monitoring (DOM) support is also present to allow access to real-time operating parameters. This transceiver is Trade Agreements Act (TAA) compliant. We stand behind the quality of our products and proudly offer a limited lifetime warranty.

ProLabs' transceivers are RoHS compliant and lead-free.

TAA refers to the Trade Agreements Act (19 U.S.C. & 2501-2581), which is intended to foster fair and open international trade. TAA requires that the U.S. Government may acquire only "U.S. – made or designated country end products."



Regulatory Compliance

- ESD to the Electrical PINs: compatible with MIL-STD-883G Method 3015.7
- ESD to the LC Receptacle: compatible with IEC 61000-4-3
- EMI/EMC compatible with FCC Part 15 Subpart B Rules, EN55022:2010
- Laser Eye Safety compatible with FDA 21CFR, EN60950-1& EN (IEC) 60825-1,2
- RoHS compliant with EU RoHS 2.0 directive 2015/863/EU

CWDM Wavelength

Band	Channels	Wavelength		
		Min.	Typ.	Max.
O-Band	27	1264	1270	1277.5
	29	1284	1290	1297.5
	31	1304	1310	1317.5
	33	1324	1330	1337.5
	35	1344	1350	1357.5
E-Band Extended	37	1364	1370	1377.5
	39	1384	1390	1397.5
	41	1404	1410	1417.5
	43	1424	1430	1437.5
	45	1444	1450	1457.5

Absolute Maximum Ratings

Parameter	Symbol	Min	Max	Unit
Storage Temperature	TS	-40	+85	°C
Maximum Supply Voltage	VCC	-0.5	3.6	V
Operating Relative Humidity			95	%
Operating Case Temperature	Tc	0	+70	°C

*Exceeding any one of these values may destroy the device immediately.

Electrical Characteristics

Parameter	Symbol	Min.	Typ.	Max.	Unit	Notes
Power Supply Voltage	Vcc	3.15	3.3	3.45	V	
Power Supply Current	Icc			750	mA	
Transmitter						
Input differential Impedance	Rin		100			
Differential data input	Vin,pp	120		820	mV	1
Transmit Disable Voltage	VD	2.0		Vcc	V	
Transmit Enable Voltage	VEN	GND		GND +0.8	V	
Transmit Disable Assert Time				10	us	
Receiver						
Differential data output swing	Vout,pp	340	650	850	mV	1
RX Rise time (20-80%)	tr			38	ps	
RX Fall time (20-80%)	tf			38	ps	
LOS Fault	VLOS fault	Vcc – 0.5		VccHOST	V	2
LOS Normal	VLOS norm	GND		GND+0.5		2

Notes:

1. After internal AC coupling
2. Loss of signal is open collector to be pulled up to with a 4.7k-10kohm resistor to 3.15-3.6V. Logic 0 indicates normal operation; logic 1 indicates no signal detected.

Optical Characteristics

Parameter	Symbol	Min.	Typ.	Max.	Unit	Notes
Power Budget	PB		14		dB	
Data Rate			10.3125		Gbps	
Transmitter						
Center Wavelength	λ_C	λ_C-6	λ_C	$\lambda_C-7.5$	nm	
Spectral Width (-20dB)	$\Delta\lambda$			1	nm	
Side Mode Suppression Ratio	SMSR	30			dB	
Average Output Power	Pout	-1		4	dBm	3
Extinction Ratio	ER	3.5			dB	
Pout@TX Disable Asserted	Pout			-30	dBm	
Receiver						
Center Wavelength	λ_C	1260		1600	nm	
Receiver Sensitivity	Pmin			-15	dBm	4
Receiver Overload	Pmax	0.5			dBm	
LOS De-Assert	LOSD			-17.8	dBm	
LOS Assert	LOSA	-29.8			dBm	
LOS Hysteresis		1			dB	

Notes:

1. Output power is coupled into a 9/125 μ m SMF.
2. Average received power; BER less than 1E-12 and PRBS 231-1 test pattern.

Pin Descriptions

Pin	Symbol	Function	Notes
1	GND	Module Ground	1
2	V _{EE5}	Optional -5.2 Power Supply - Not Required	
3	Mod_Desel	Module De-select; When held low allows module to respond to 2-wire serial interface commands	
4	Interrupt	Interrupt; Indicates presence of an important condition which can be read over the 2-wire serial interface.	2
5	TX_DIS	Transmitter Disable; Transmitter laser source turned off	
6	VCC5	+5V Power Supply – Not required	
7	GND	Module Ground	1
8	VCC3	+3.3V Power Supply	
9	VCC3	+3.3V Power Supply	
10	SCL	Serial 2-wire Interface clock.	2
11	SDA	Serial 2-wire Interface Data Line	2
12	Mod_Abs	Module Absent: Indicated module is not present. Grounded in the module.	2
13	Mod_NR	Module Not Ready	2
14	RX_LOS	Receiver Loss of Signal Indicator	2
15	GND	Module Ground	1
16	GND	Module Ground	1
17	RD-	Receiver Inverted Data Output	
18	RD+	Receiver Non-Inverted Data Output	
19	GND	Module Ground	1
20	VCC2	+1.8V Power Supply (Not required).	
21	P_DOWN/RST	Power down; When high, places the module in the low power stand-by mode and on the falling edge of P_Down initiates a module reset Reset; The falling edge initiates a complete reset of the module including the 2-wire serial interface, equivalent to a power cycle.	
22	VCC2	+1.8V Power Supply (Not required)	
23	GND	Module Ground	1
24	REFCLK+	Reference Clock Non-Inverted Input, AC coupled on the host board - Not Required	3
25	REFCLK-	Reference Clock Inverted Input, AC coupled on the host board – Not Required	3
26	GND	Module Ground	1
27	GND	Module Ground	1
28	TD-	Transmitter Inverted Data Input	
29	TD+	Transmitter Non-Inverted Data Input	
30	GND	Module Ground	1

Notes:

- 1. Module circuit ground is isolated from module chassis ground within the module.
- 2. Open collector; should be pulled up with 4.7k-10k ohms on host board to a voltage between 3.15V and 3.6V.
- 3. Reference Clock input is not required.

Electrical Pin-out Details

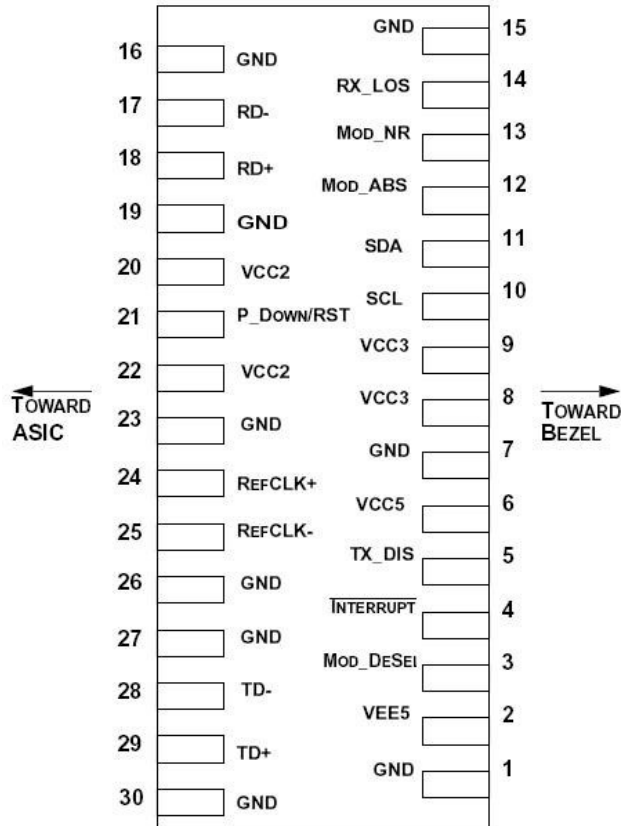

Recommended Host Board Power Supply Circuit

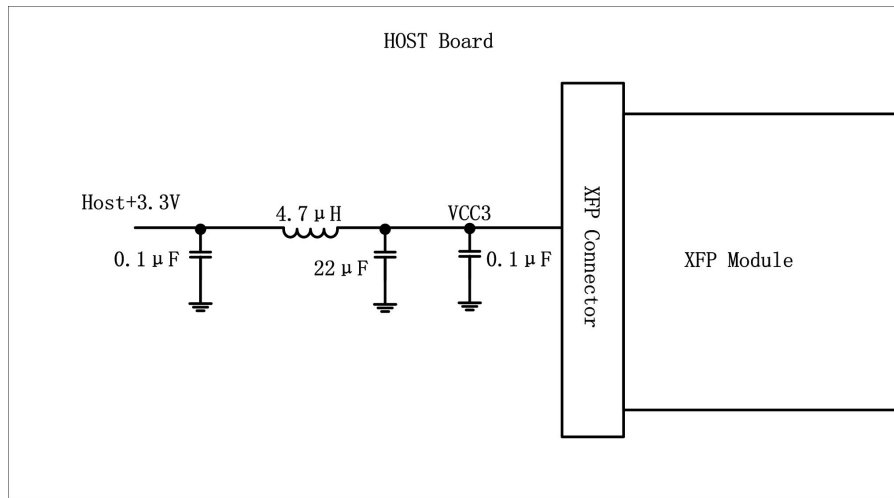

Recommend High-speed Interface Circuit

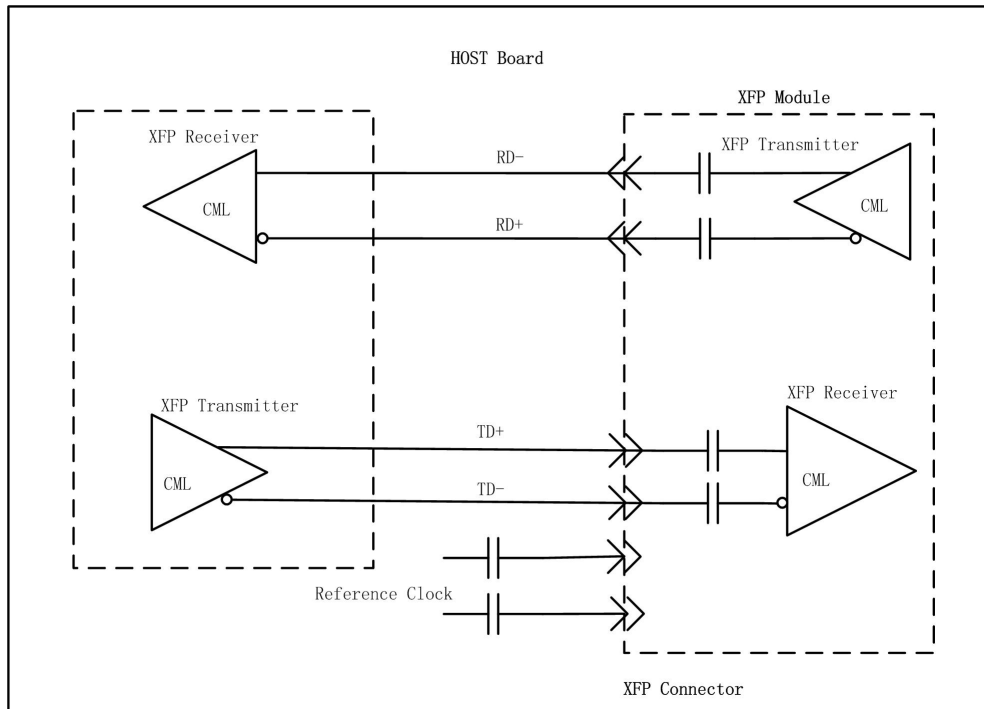

Mechanical Specifications

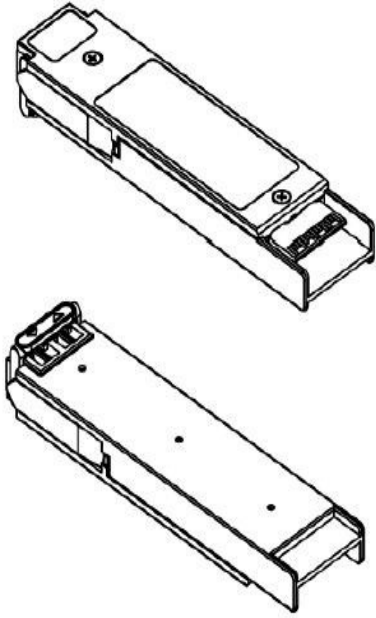
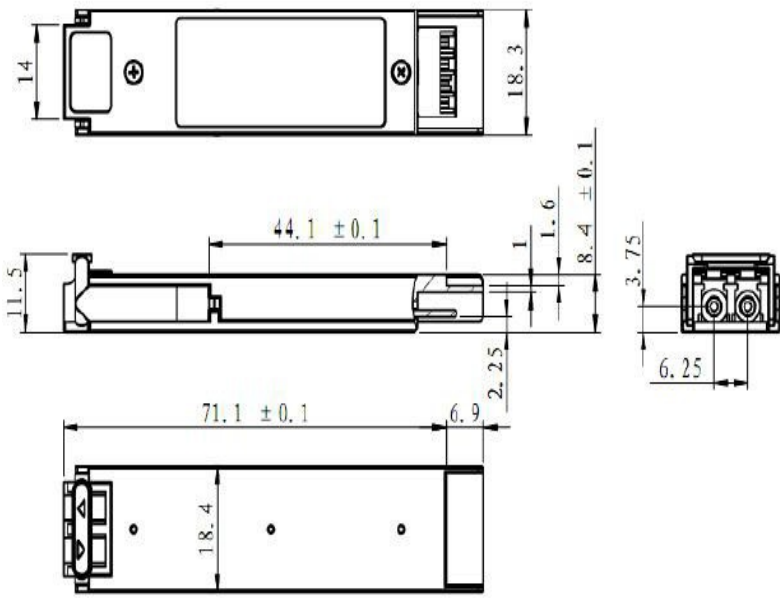

About ProLabs

Our experience comes as standard; for over 15 years ProLabs has delivered optical connectivity solutions that give our customers freedom and choice through our ability to provide seamless interoperability. At the heart of our company is the ability to provide state-of-the-art optical transport and connectivity solutions that are compatible with over 90 optical switching and transport platforms.

Complete Portfolio of Network Solutions

ProLabs is focused on innovations in optical transport and connectivity. The combination of our knowledge of optics and networking equipment enables ProLabs to be your single source for optical transport and connectivity solutions from 100Mb to 400G while providing innovative solutions that increase network efficiency. We provide the optical connectivity expertise that is compatible with and enhances your switching and transport equipment.

Trusted Partner

Customer service is our number one value. ProLabs has invested in people, labs and manufacturing capacity to ensure that you get immediate answers to your questions and compatible product when needed. With Engineering and Manufacturing offices in the U.K. and U.S. augmented by field offices throughout the U.S., U.K. and Asia, ProLabs is able to be our customers best advocate 24 hours a day.

Contact Information

ProLabs US

Email: sales@prolabs.com

Telephone: 952-852-0252

ProLabs UK

Email: salessupport@prolabs.com

Telephone: +44 1285 719 600