

Mechanical Dimensions: Inches [mm]

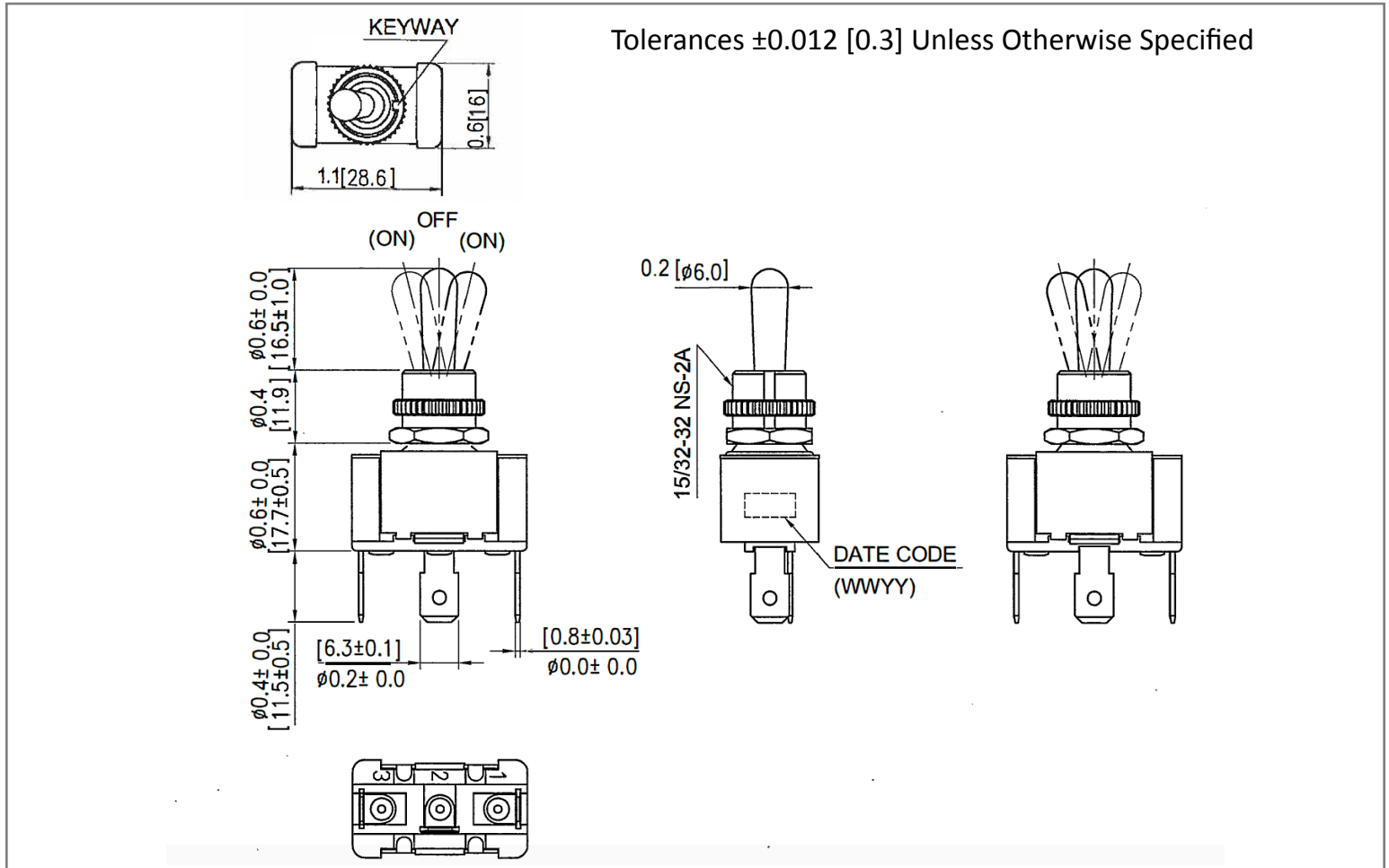

Mounting Hole

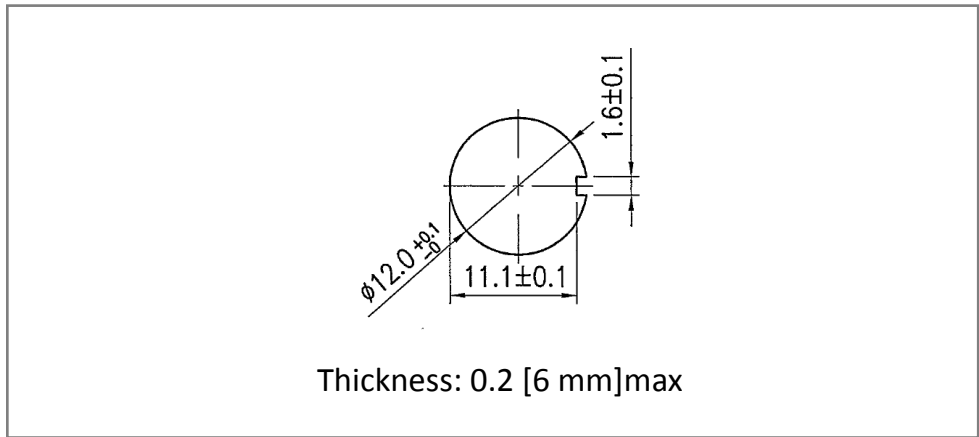

Circuit Diagram

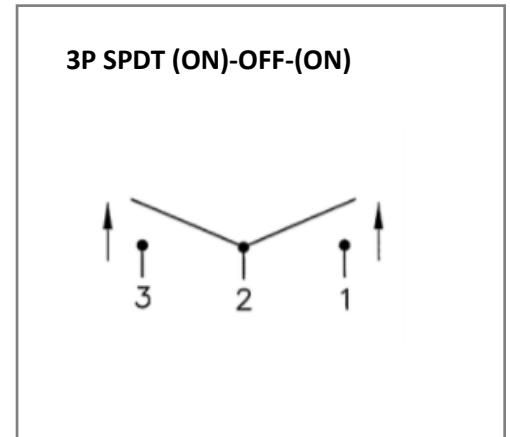

Electrical Specifications

Rating	21A 14V DC
Contact Resistance	50m ohm Max
Insulation Resistance	DC 500V 100M ohm Min
Dielectric Strength	AC 1500V 1 minute
Operation Temperature	-20°C ~ 85°C

Material Specifications

Operation Force	1500gf \pm 300 gf
	1 hex nut assy
	1 knurl nut assy

Rev	Date of issue	Revision Notes	Designed	Approved
A	02-13-2019	Initial Drawing	RC	OH