



LOOMIA

PROTOTYPING PACKS & PARTS

Pinout Guide

Beta Version - 6.2020

Pad Guide

Single Backlit User Interface Component

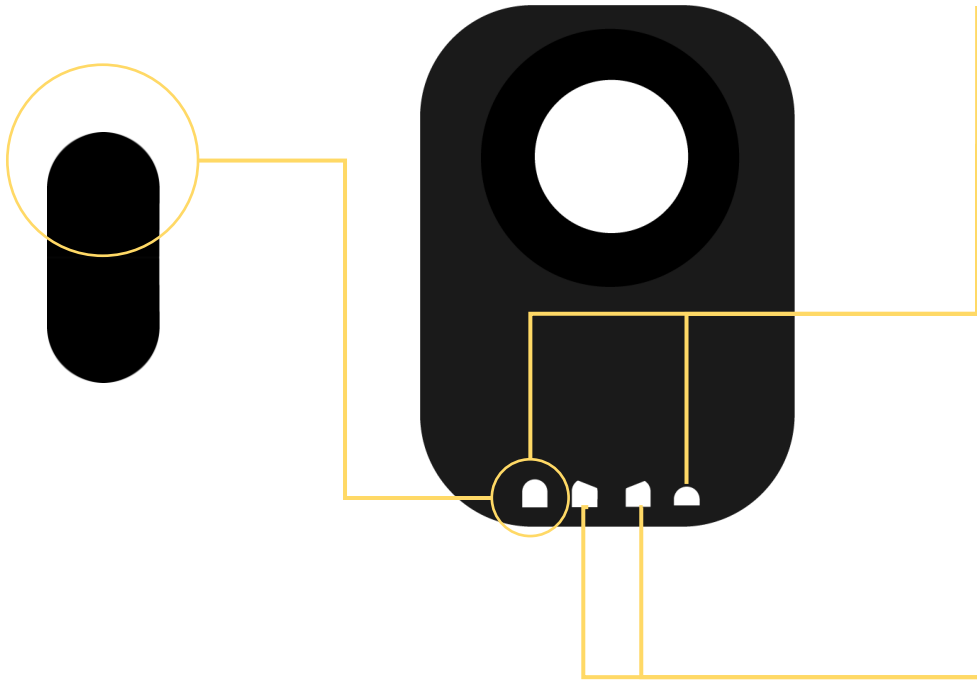

- Power and Ground for Heater and LED



- Row and Column for Pressure Sensor



- Top and Bottom for User Interface



Each part has pads that are shaped to help with assembly. All buses and power connections make a pill when soldered together (shown above). Other parts, make different versions of the pill (shown right) depending on the functionality of each lead.

User Interface

- Backlit

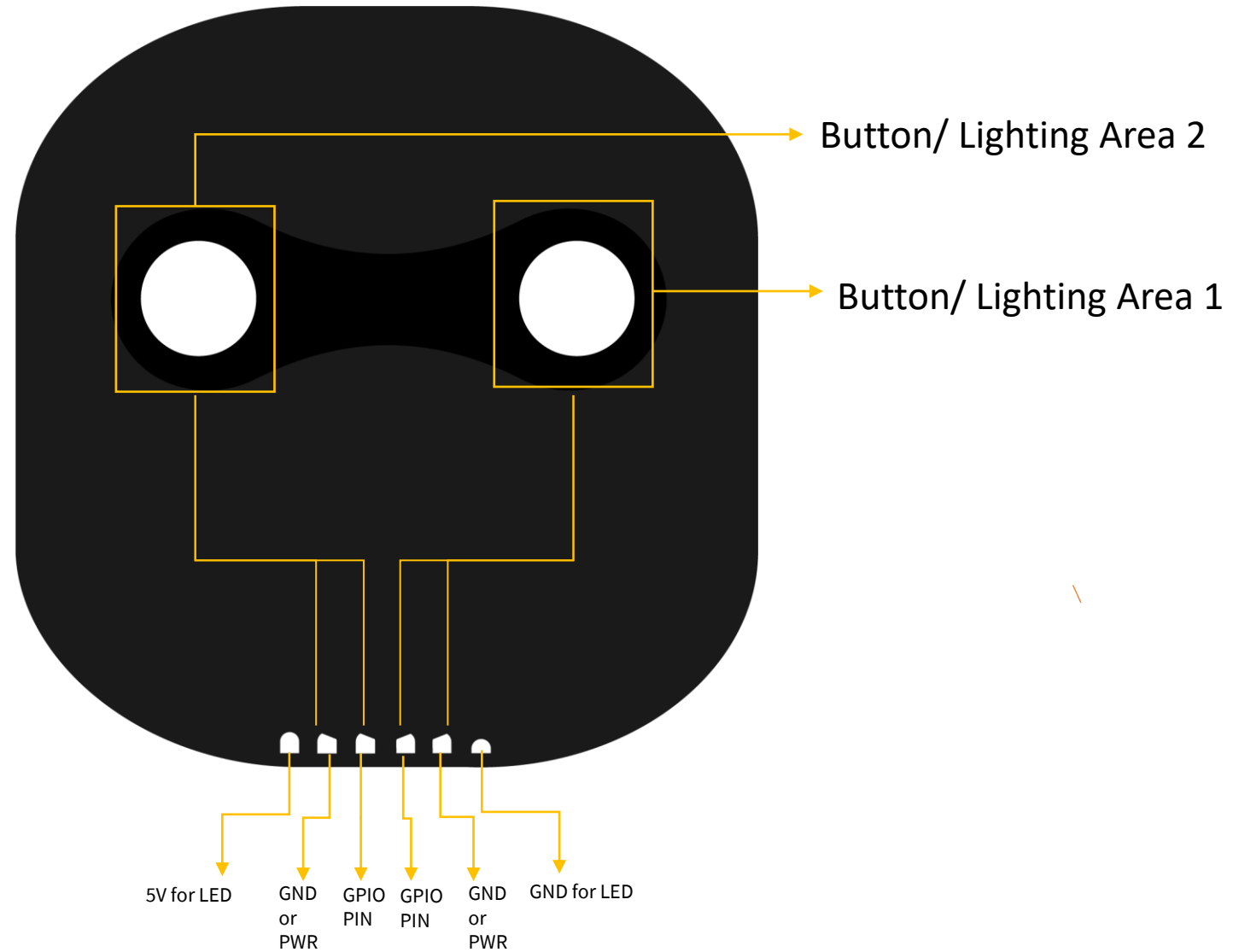
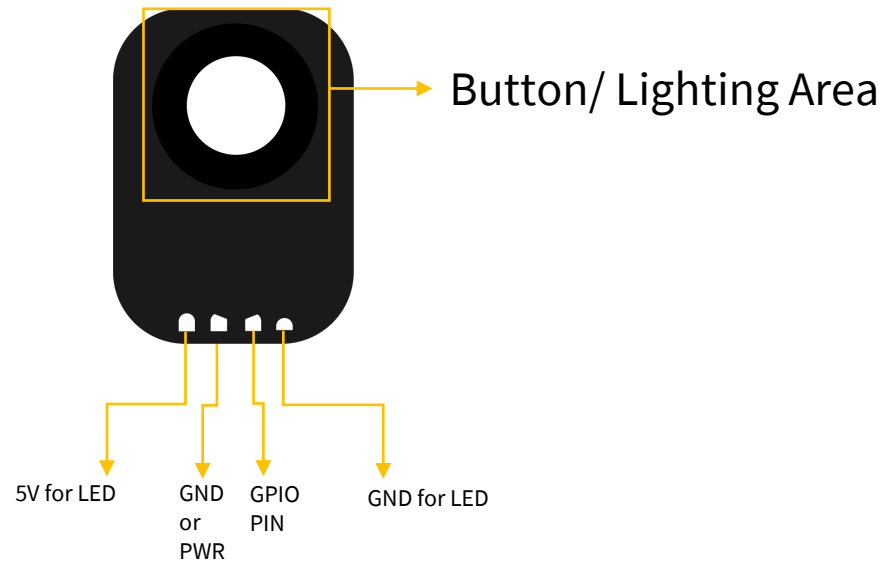

User Interface

- Pressure

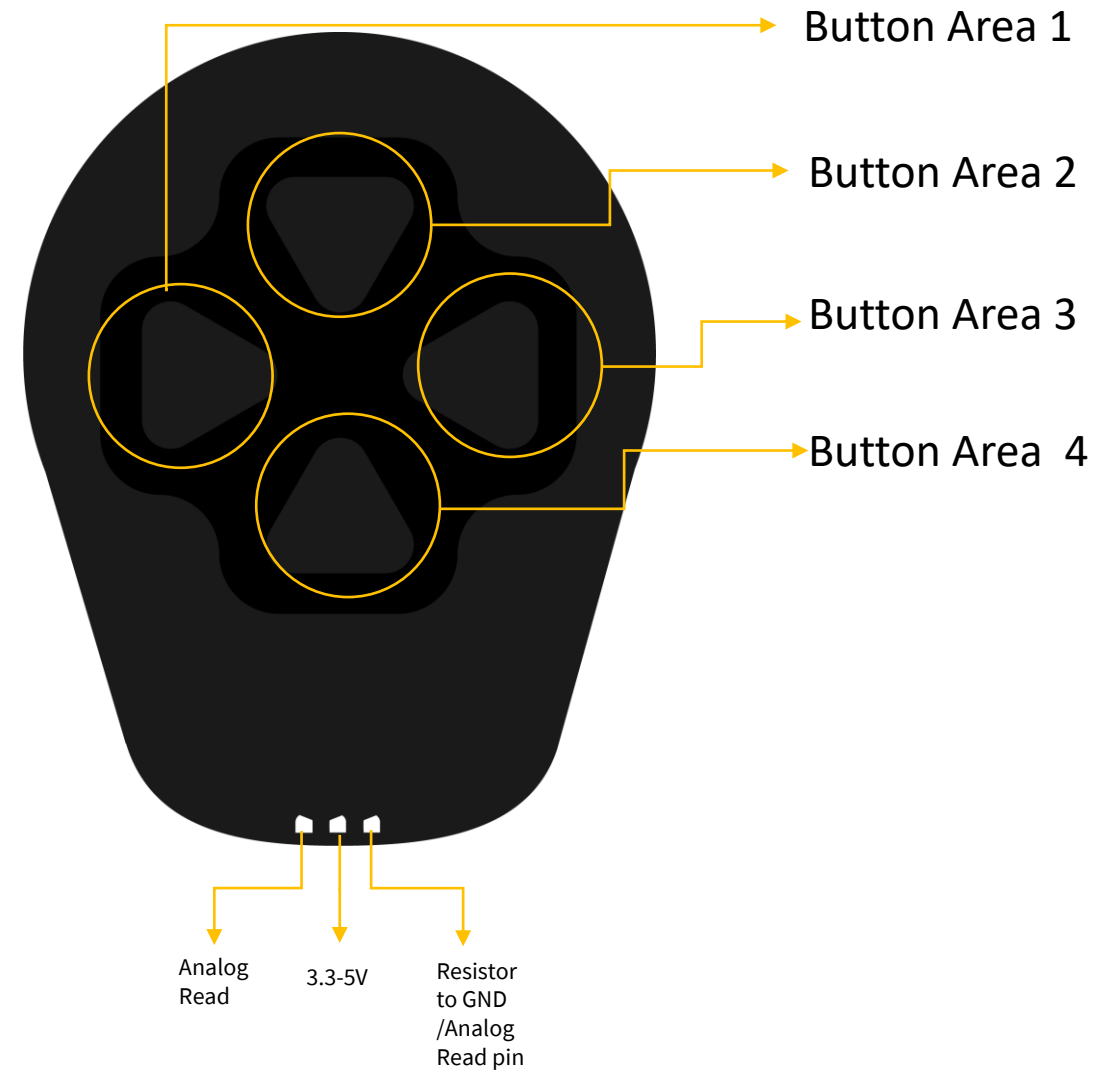
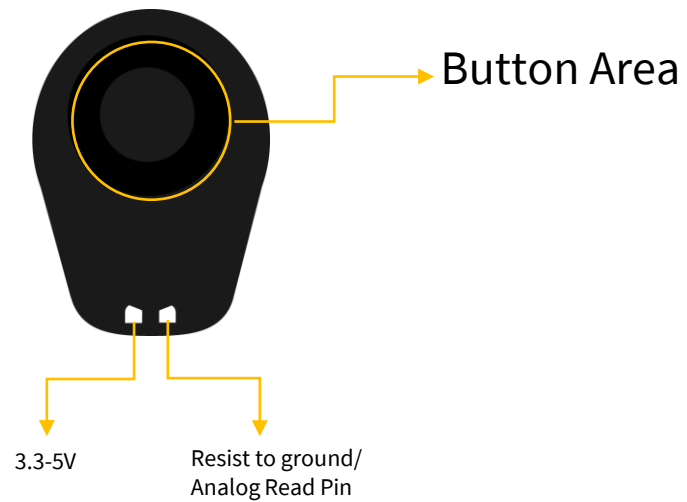

Heater

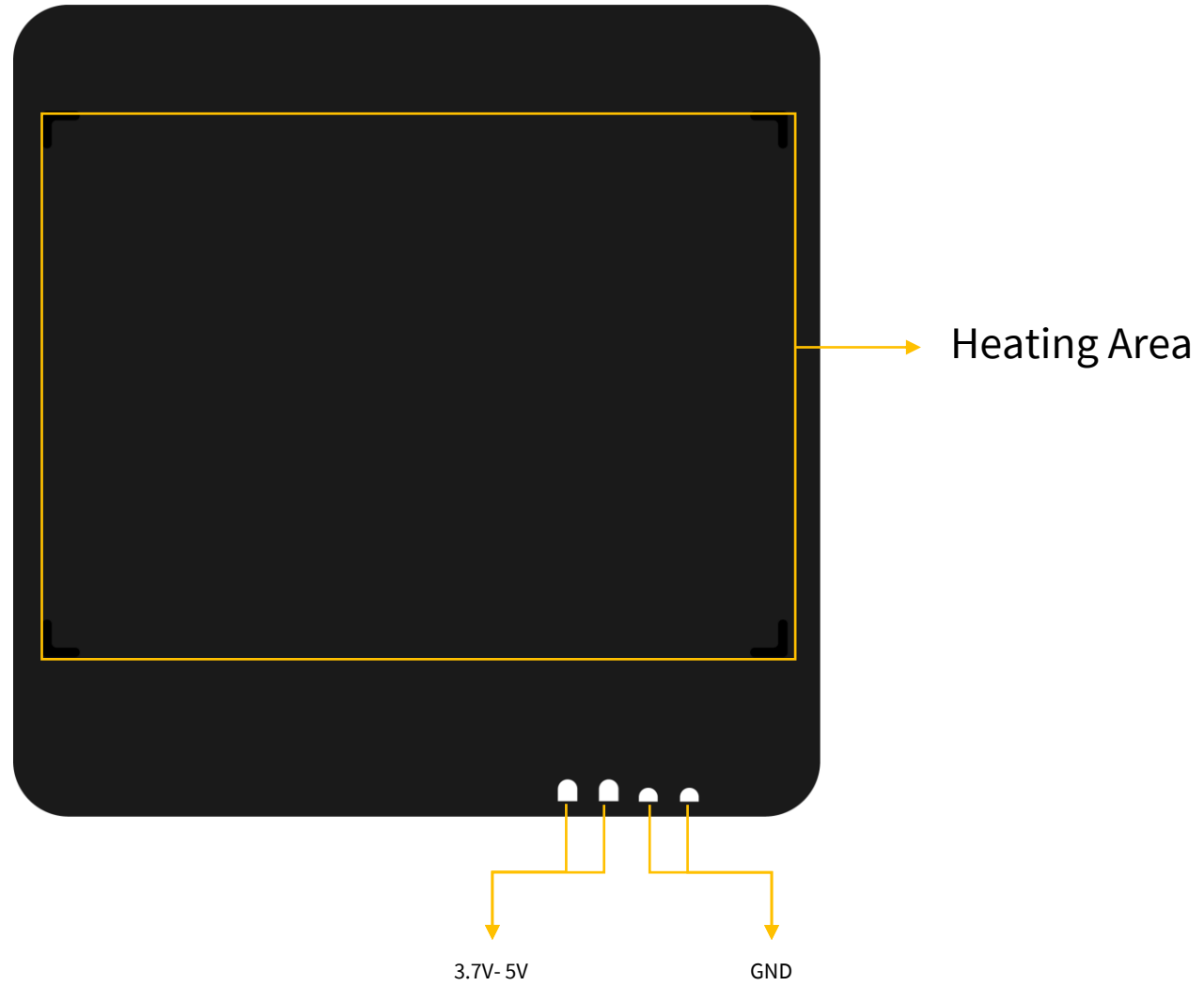

Pressure Sensor

- Simple

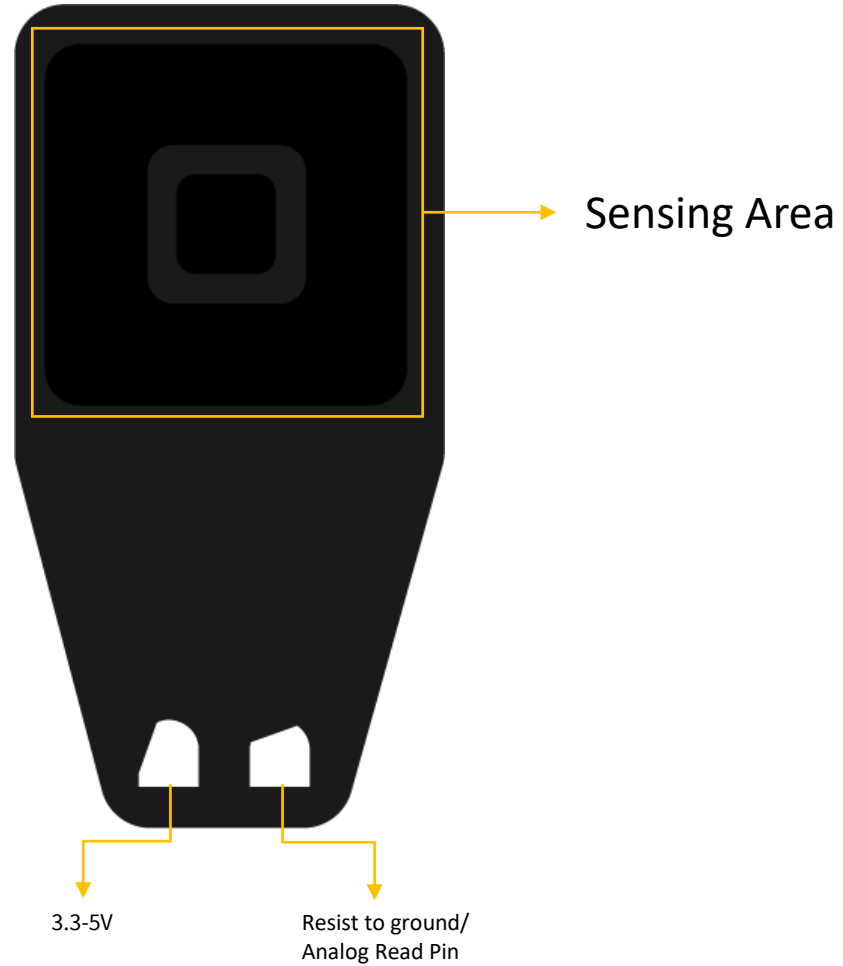

Pressure Sensor

- Matrix

