

N-channel 600 V, 0.78 Ω typ., 6 A MDmesh™ DM2 Power MOSFET in a DPAK package

Datasheet - production data

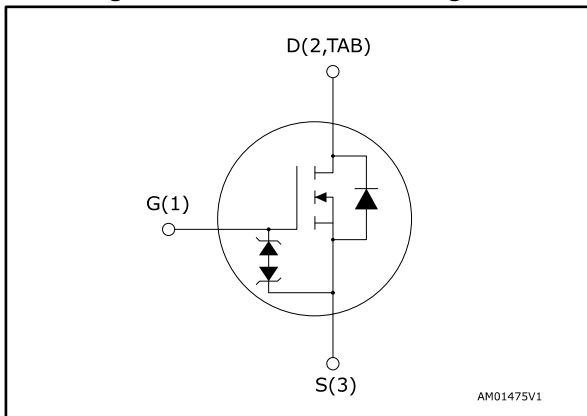

Figure 1: Internal schematic diagram



Features

| Order code | V _{DS} | R _{DS(on)} max. | I _D | P _{TOT} |
|------------|-----------------|--------------------------|----------------|------------------|
| STD7N60DM2 | 600 V | 0.90 Ω | 6 A | 60 W |

- Fast-recovery body diode
- Extremely low gate charge and input capacitance
- Low on-resistance
- 100% avalanche tested
- Extremely high dv/dt ruggedness
- Zener-protected

Applications

- Switching applications

Description

This high voltage N-channel Power MOSFET is part of the MDmesh™ DM2 fast recovery diode series. It offers very low recovery charge (Q_{rr}) and time (t_{rr}) combined with low $R_{DS(on)}$, rendering it suitable for the most demanding high efficiency converters and ideal for bridge topologies and ZVS phase-shift converters.

Table 1: Device summary

| Order code | Marking | Package | Packing |
|------------|---------|---------|---------------|
| STD7N60DM2 | 7N60DM2 | DPAK | Tape and reel |

Contents

| | | |
|----------|---|-----------|
| 1 | Electrical ratings | 3 |
| 2 | Electrical characteristics | 4 |
| | 2.1 Electrical characteristics (curves)..... | 6 |
| 3 | Test circuits | 8 |
| 4 | Package information | 9 |
| | 4.1 DPAK (TO-252) type A package information..... | 9 |
| | 4.2 DPAK (TO-252) packing information..... | 12 |
| 5 | Revision history | 14 |

1 Electrical ratings

Table 2: Absolute maximum ratings

| Symbol | Parameter | Value | Unit |
|----------------|--|------------|------------------|
| V_{GS} | Gate-source voltage | ± 25 | V |
| I_D | Drain current (continuous) at $T_{case} = 25\text{ }^\circ\text{C}$ | 6 | A |
| | Drain current (continuous) at $T_{case} = 100\text{ }^\circ\text{C}$ | 3.8 | |
| $I_{DM}^{(1)}$ | Drain current (pulsed) | 24 | A |
| P_{TOT} | Total dissipation at $T_{case} = 25\text{ }^\circ\text{C}$ | 60 | W |
| $dv/dt^{(2)}$ | Peak diode recovery voltage slope | 50 | V/ns |
| $dv/dt^{(3)}$ | MOSFET dv/dt ruggedness | 50 | |
| T_{stg} | Storage temperature range | -55 to 150 | $^\circ\text{C}$ |
| T_j | Operating junction temperature range | | |

Notes:

- (1) Pulse width is limited by safe operating area.
 (2) $I_{SD} \leq 6\text{ A}$, $di/dt=900\text{ A}/\mu\text{s}$; $V_{DS\text{ peak}} < V_{(BR)DSS}$, $V_{DD} = 480\text{ V}$.
 (3) $V_{DS} \leq 480\text{ V}$.

Table 3: Thermal data

| Symbol | Parameter | Value | Unit |
|---------------------|----------------------------------|-------|---------------------------|
| $R_{thj-case}$ | Thermal resistance junction-case | 2.08 | $^\circ\text{C}/\text{W}$ |
| $R_{thj-pcb}^{(1)}$ | Thermal resistance junction-pcb | 50 | |

Notes:

- (1) When mounted on a 1-inch² FR-4, 2 Oz copper board.

Table 4: Avalanche characteristics

| Symbol | Parameter | Value | Unit |
|----------------|---|-------|------|
| $I_{AR}^{(1)}$ | Avalanche current, repetitive or not repetitive | 1.5 | A |
| $E_{AS}^{(2)}$ | Single pulse avalanche energy | 160 | mJ |

Notes:

- (1) Pulse width limited by T_{jmax} .
 (2) Starting $T_j = 25\text{ }^\circ\text{C}$, $I_D = I_{AR}$, $V_{DD} = 50\text{ V}$.

2 Electrical characteristics

($T_{\text{case}} = 25\text{ °C}$ unless otherwise specified)

Table 5: Static

| Symbol | Parameter | Test conditions | Min. | Typ. | Max. | Unit |
|-----------------------------|-----------------------------------|---|------|------|---------|---------------|
| $V_{(\text{BR})\text{DSS}}$ | Drain-source breakdown voltage | $V_{\text{GS}} = 0\text{ V}$, $I_{\text{D}} = 1\text{ mA}$ | 600 | | | V |
| I_{DSS} | Zero gate voltage drain current | $V_{\text{GS}} = 0\text{ V}$, $V_{\text{DS}} = 600\text{ V}$ | | | 1 | μA |
| | | $V_{\text{GS}} = 0\text{ V}$, $V_{\text{DS}} = 600\text{ V}$, $T_{\text{case}} = 125\text{ °C}$ ⁽¹⁾ | | | 100 | |
| I_{GSS} | Gate-body leakage current | $V_{\text{DS}} = 0\text{ V}$, $V_{\text{GS}} = \pm 25\text{ V}$ | | | ± 5 | μA |
| $V_{\text{GS(th)}}$ | Gate threshold voltage | $V_{\text{DS}} = V_{\text{GS}}$, $I_{\text{D}} = 250\text{ }\mu\text{A}$ | 3.25 | 4 | 4.75 | V |
| $R_{\text{DS(on)}}$ | Static drain-source on-resistance | $V_{\text{GS}} = 10\text{ V}$, $I_{\text{D}} = 3\text{ A}$ | | 0.78 | 0.90 | Ω |

Notes:

⁽¹⁾ Defined by design, not subject to production test.

Table 6: Dynamic

| Symbol | Parameter | Test conditions | Min. | Typ. | Max. | Unit |
|----------------------------|-------------------------------|--|------|------|------|-------------|
| C_{ISS} | Input capacitance | $V_{\text{DS}} = 100\text{ V}$, $f = 1\text{ MHz}$, $V_{\text{GS}} = 0\text{ V}$ | - | 324 | - | pF |
| C_{OSS} | Output capacitance | | - | 18 | - | |
| C_{RSS} | Reverse transfer capacitance | | - | 2 | - | |
| $C_{\text{OSS eq.}}^{(1)}$ | Equivalent output capacitance | $V_{\text{DS}} = 0\text{ to }480\text{ V}$, $V_{\text{GS}} = 0\text{ V}$ | - | 25 | - | pF |
| R_{G} | Intrinsic gate resistance | $f = 1\text{ MHz}$, $I_{\text{D}} = 0\text{ A}$ | - | 6 | - | Ω |
| Q_{g} | Total gate charge | $V_{\text{DD}} = 480\text{ V}$, $I_{\text{D}} = 6\text{ A}$, $V_{\text{GS}} = 0\text{ to }10\text{ V}$ (see Figure 15: "Test circuit for gate charge behavior") | - | 7.5 | - | nC |
| Q_{gs} | Gate-source charge | | - | 2.2 | - | |
| Q_{gd} | Gate-drain charge | | - | 3.2 | - | |

Notes:

⁽¹⁾ $C_{\text{OSS eq.}}$ is defined as a constant equivalent capacitance giving the same charging time as C_{OSS} when V_{DS} increases from 0 to 80% V_{DSS} .

Table 7: Switching times

| Symbol | Parameter | Test conditions | Min. | Typ. | Max. | Unit |
|---------------------|---------------------|--|------|------|------|-------------|
| $t_{\text{d(on)}}$ | Turn-on delay time | $V_{\text{DD}} = 300\text{ V}$, $I_{\text{D}} = 3\text{ A}$ $R_{\text{G}} = 4.7\text{ }\Omega$, $V_{\text{GS}} = 10\text{ V}$ (see Figure 14: "Test circuit for resistive load switching times" and Figure 19: "Switching time waveform") | - | 10 | - | ns |
| t_{r} | Rise time | | - | 6 | - | |
| $t_{\text{d(off)}}$ | Turn-off delay time | | - | 12.6 | - | |
| t_{f} | Fall time | | - | 22.6 | - | |

Table 8: Source-drain diode

| Symbol | Parameter | Test conditions | Min. | Typ. | Max. | Unit |
|-----------------|-------------------------------|--|------|------|------|------|
| I_{SD} | Source-drain current | | - | | 6 | A |
| $I_{SDM}^{(1)}$ | Source-drain current (pulsed) | | - | | 24 | A |
| $V_{SD}^{(2)}$ | Forward on voltage | $V_{GS} = 0\text{ V}$, $I_{SD} = 6\text{ A}$ | - | | 1.6 | V |
| t_{rr} | Reverse recovery time | $I_{SD} = 6\text{ A}$, $di/dt = 100\text{ A}/\mu\text{s}$, $V_{DD} = 60\text{ V}$ (see Figure 16: "Test circuit for inductive load switching and diode recovery times") | - | 69 | | ns |
| Q_{rr} | Reverse recovery charge | | - | 164 | | nC |
| I_{RRM} | Reverse recovery current | | - | 4.8 | | A |
| t_{rr} | Reverse recovery time | $I_{SD} = 6\text{ A}$, $di/dt = 100\text{ A}/\mu\text{s}$, $V_{DD} = 60\text{ V}$, $T_j = 150\text{ °C}$ (see Figure 16: "Test circuit for inductive load switching and diode recovery times") | - | 144 | | ns |
| Q_{rr} | Reverse recovery charge | | - | 492 | | nC |
| I_{RRM} | Reverse recovery current | | - | 6.8 | | A |

Notes:

- (1) Pulse width is limited by safe operating area.
(2) Pulse test: pulse duration = 300 μs , duty cycle 1.5%.

2.1 Electrical characteristics (curves)

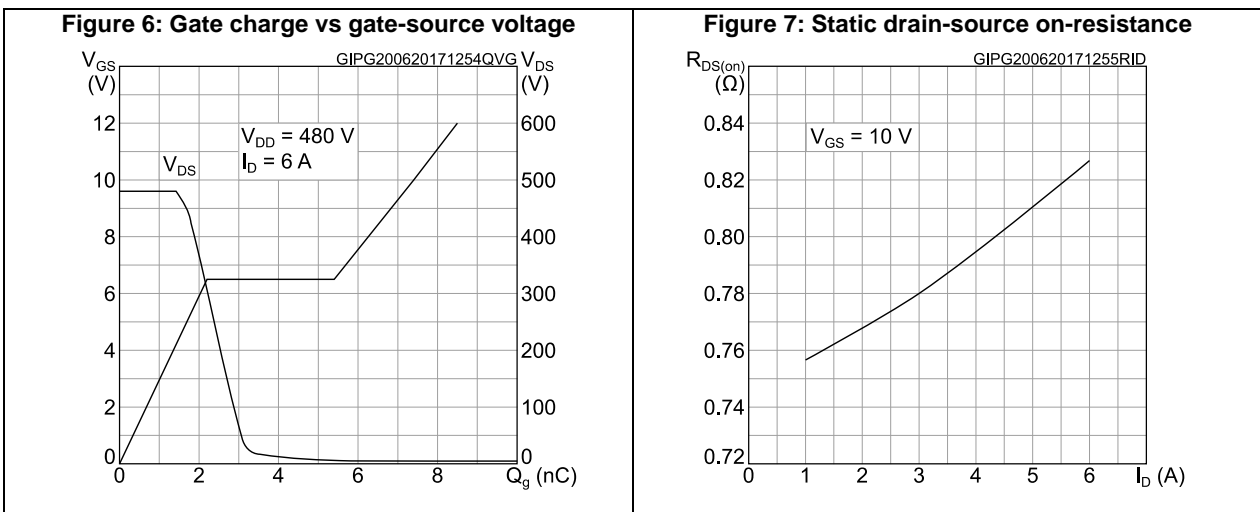
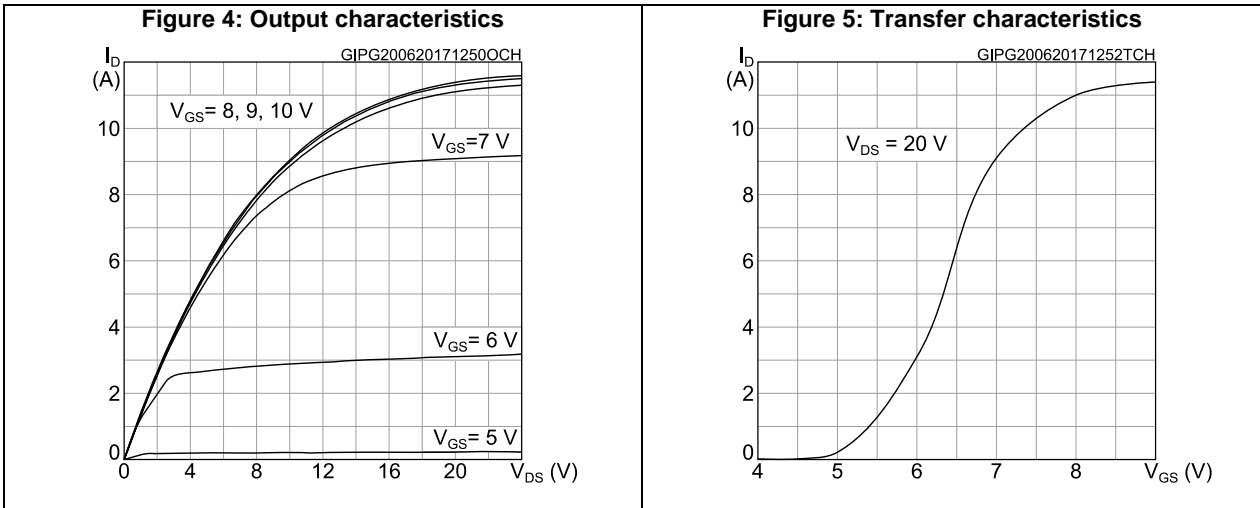
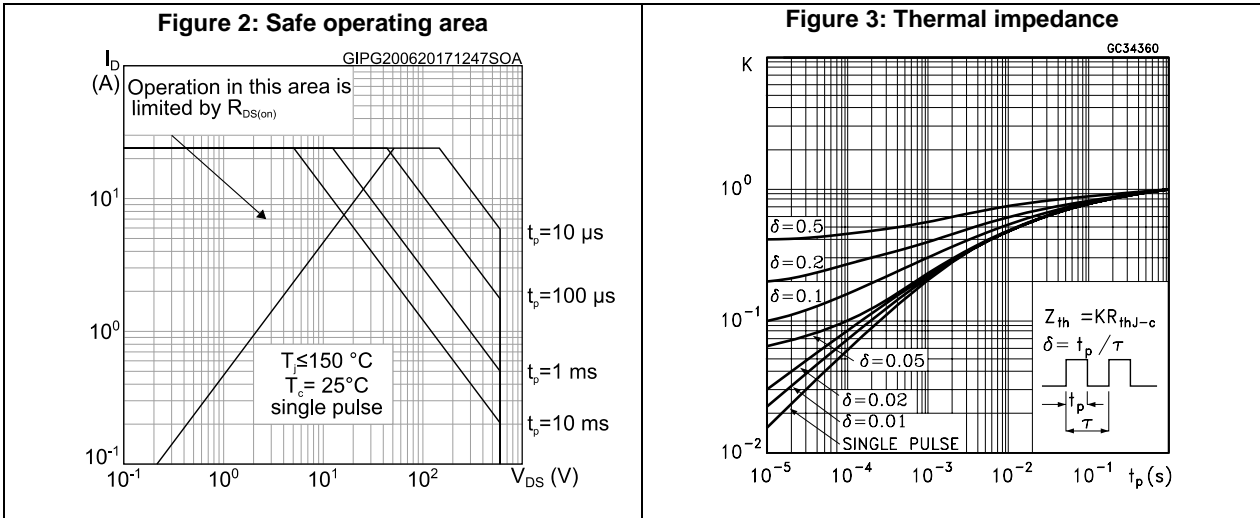

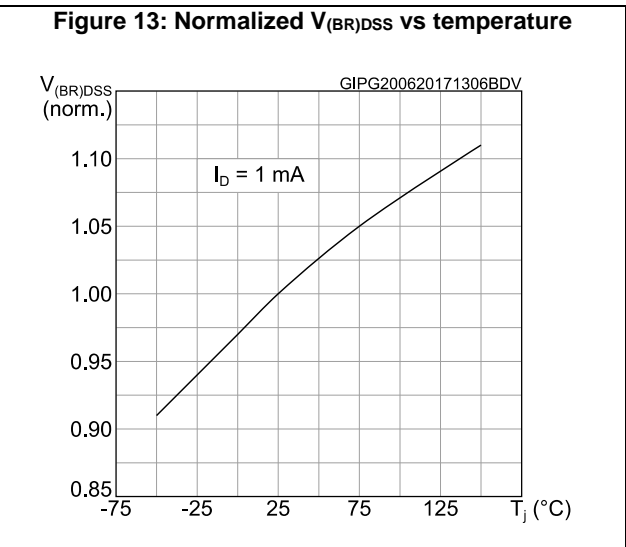
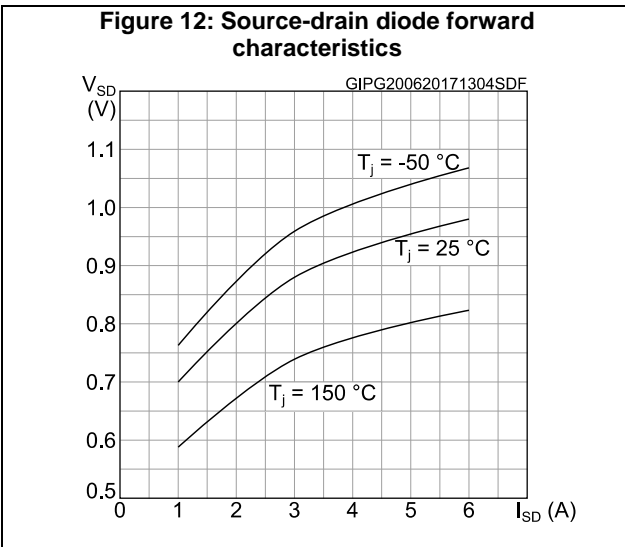
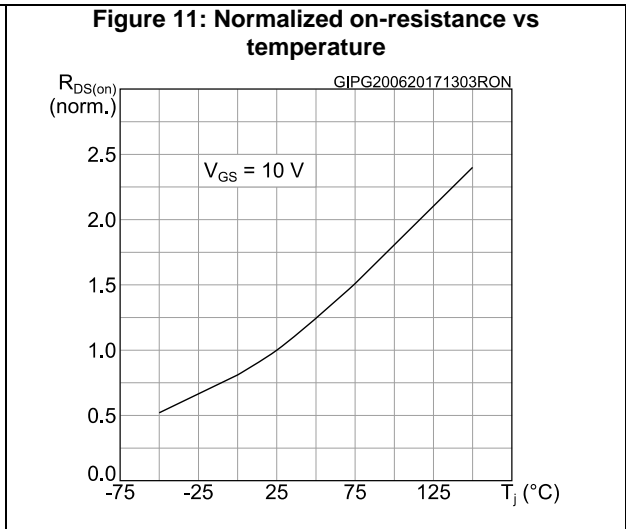
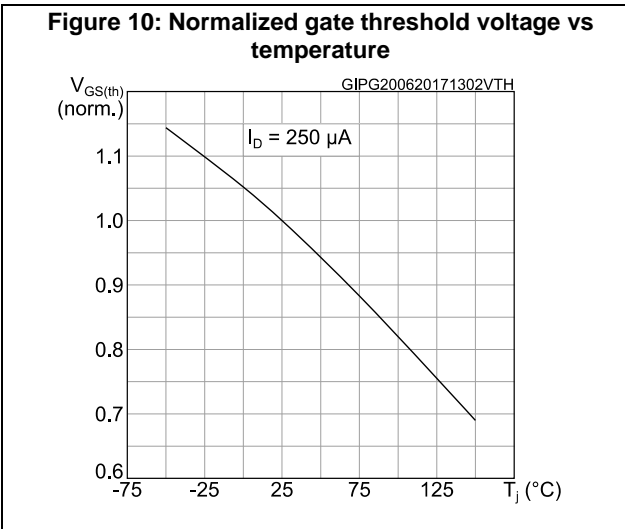
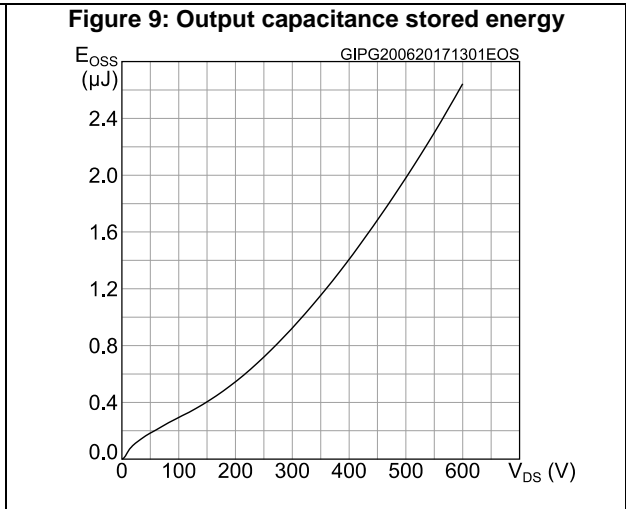
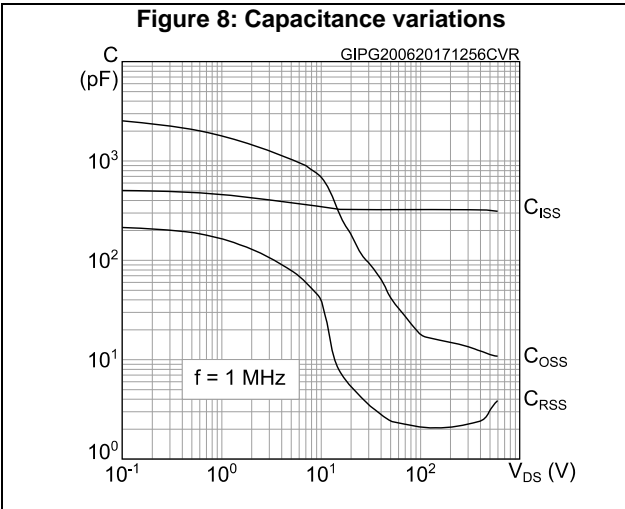

3 Test circuits

Figure 14: Test circuit for resistive load switching times



AM01468v1

Figure 15: Test circuit for gate charge behavior



AM01469v1

Figure 16: Test circuit for inductive load switching and diode recovery times



AM01470v1

Figure 17: Unclamped inductive load test circuit



AM01471v1

Figure 18: Unclamped inductive waveform

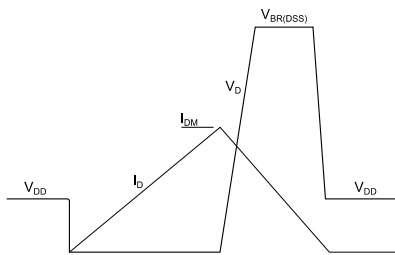

AM01472v1

Figure 19: Switching time waveform

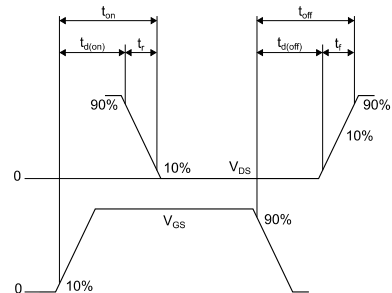

AM01473v1

4 Package information

In order to meet environmental requirements, ST offers these devices in different grades of ECOPACK® packages, depending on their level of environmental compliance. ECOPACK® specifications, grade definitions and product status are available at: www.st.com. ECOPACK® is an ST trademark.

4.1 DPAK (TO-252) type A package information

Figure 20: DPAK (TO-252) type A package outline

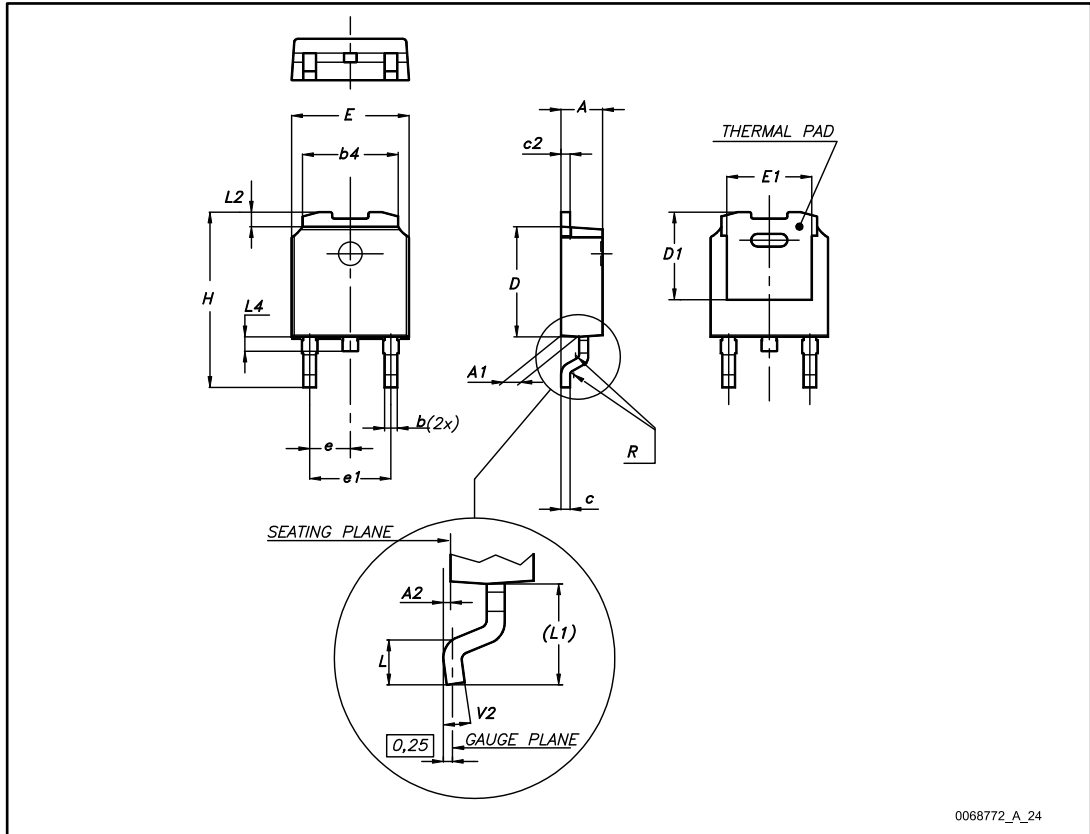
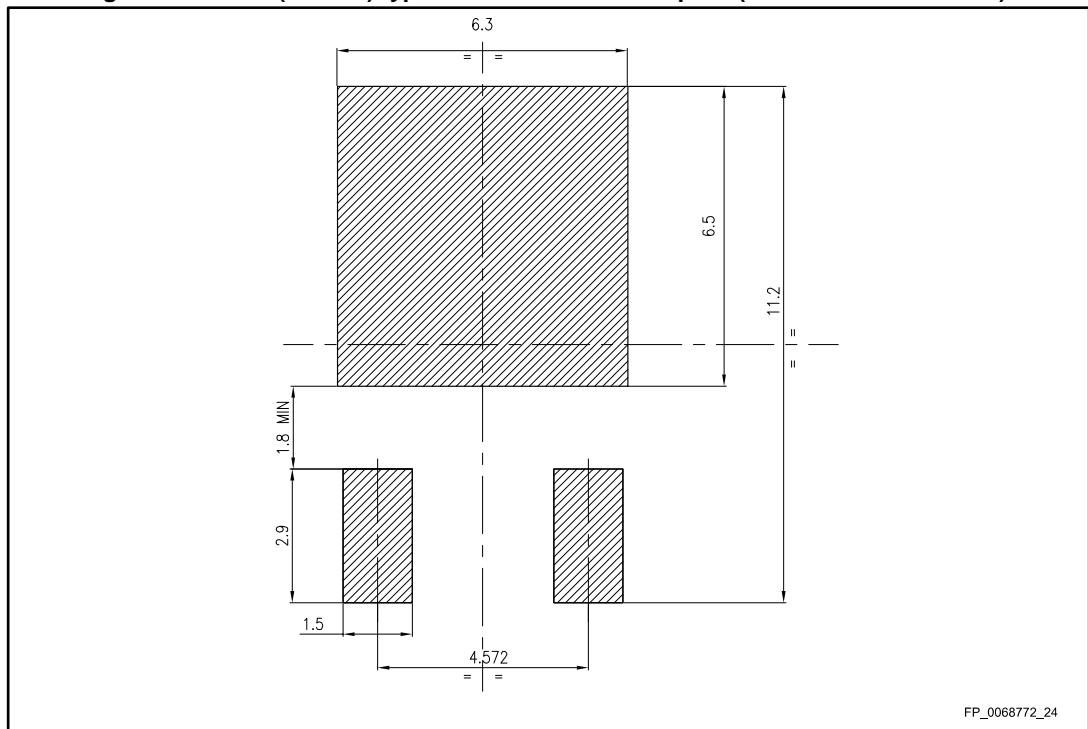

Table 9: DPAK (TO-252) type A mechanical data

| Dim. | mm | | |
|------|------|------|-------|
| | Min. | Typ. | Max. |
| A | 2.20 | | 2.40 |
| A1 | 0.90 | | 1.10 |
| A2 | 0.03 | | 0.23 |
| b | 0.64 | | 0.90 |
| b4 | 5.20 | | 5.40 |
| c | 0.45 | | 0.60 |
| c2 | 0.48 | | 0.60 |
| D | 6.00 | | 6.20 |
| D1 | 4.95 | 5.10 | 5.25 |
| E | 6.40 | | 6.60 |
| E1 | 4.60 | 4.70 | 4.80 |
| e | 2.16 | 2.28 | 2.40 |
| e1 | 4.40 | | 4.60 |
| H | 9.35 | | 10.10 |
| L | 1.00 | | 1.50 |
| (L1) | 2.60 | 2.80 | 3.00 |
| L2 | 0.65 | 0.80 | 0.95 |
| L4 | 0.60 | | 1.00 |
| R | | 0.20 | |
| V2 | 0° | | 8° |

Figure 21: DPAK (TO-252) type A recommended footprint (dimensions are in mm)



4.2 DPAK (TO-252) packing information

Figure 22: DPAK (TO-252) tape outline

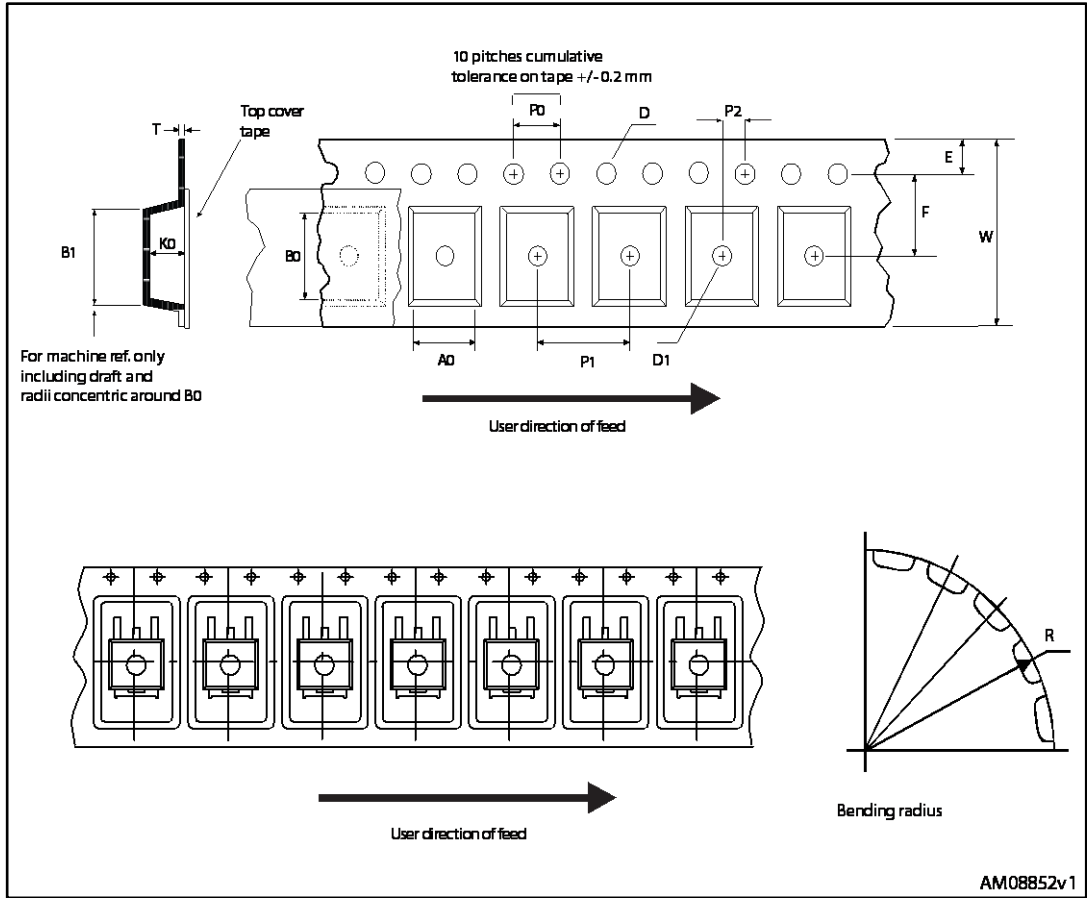
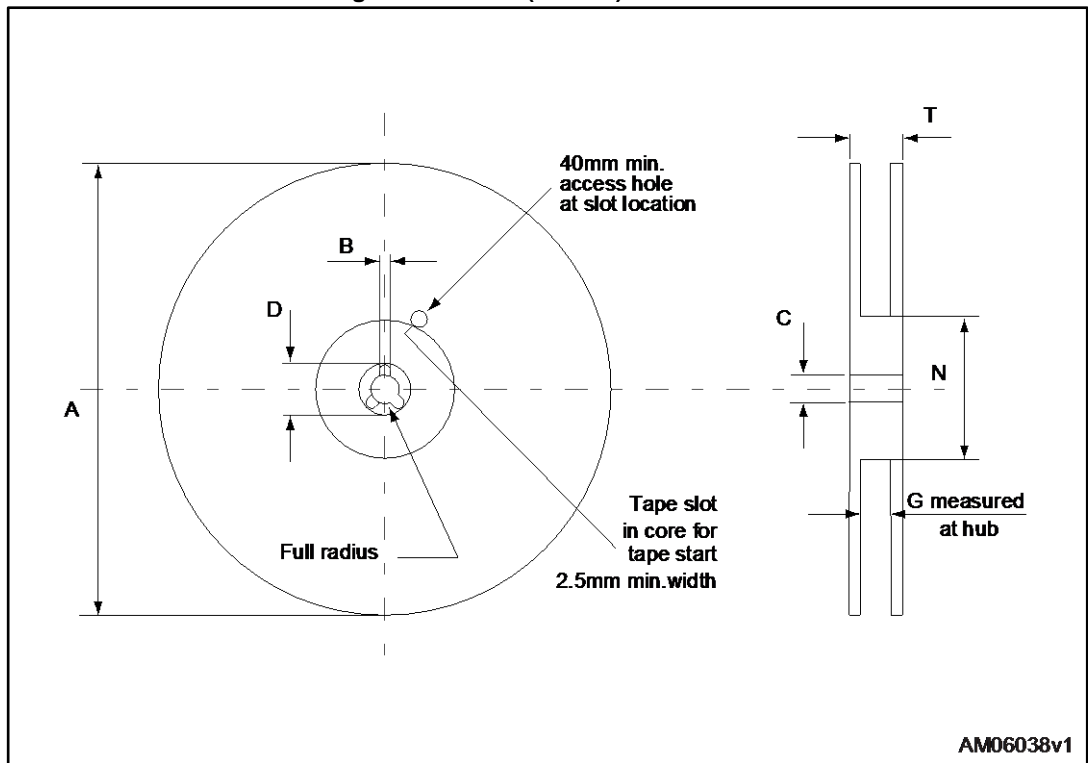

Figure 23: DPAK (TO-252) reel outline



AM06038v1

Table 10: DPAK (TO-252) tape and reel mechanical data

| Tape | | | Reel | | |
|------|------|------|-----------|------|------|
| Dim. | mm | | Dim. | mm | |
| | Min. | Max. | | Min. | Max. |
| A0 | 6.8 | 7 | A | | 330 |
| B0 | 10.4 | 10.6 | B | 1.5 | |
| B1 | | 12.1 | C | 12.8 | 13.2 |
| D | 1.5 | 1.6 | D | 20.2 | |
| D1 | 1.5 | | G | 16.4 | 18.4 |
| E | 1.65 | 1.85 | N | 50 | |
| F | 7.4 | 7.6 | T | | 22.4 |
| K0 | 2.55 | 2.75 | | | |
| P0 | 3.9 | 4.1 | Base qty. | | 2500 |
| P1 | 7.9 | 8.1 | Bulk qty. | | 2500 |
| P2 | 1.9 | 2.1 | | | |
| R | 40 | | | | |
| T | 0.25 | 0.35 | | | |
| W | 15.7 | 16.3 | | | |

5 Revision history

Table 11: Document revision history

| Date | Revision | Changes |
|-------------|----------|----------------|
| 20-Jun-2017 | 1 | First release. |

IMPORTANT NOTICE – PLEASE READ CAREFULLY

STMicroelectronics NV and its subsidiaries ("ST") reserve the right to make changes, corrections, enhancements, modifications, and improvements to ST products and/or to this document at any time without notice. Purchasers should obtain the latest relevant information on ST products before placing orders. ST products are sold pursuant to ST's terms and conditions of sale in place at the time of order acknowledgement.

Purchasers are solely responsible for the choice, selection, and use of ST products and ST assumes no liability for application assistance or the design of Purchasers' products.

No license, express or implied, to any intellectual property right is granted by ST herein.

Resale of ST products with provisions different from the information set forth herein shall void any warranty granted by ST for such product.

ST and the ST logo are trademarks of ST. All other product or service names are the property of their respective owners.

Information in this document supersedes and replaces information previously supplied in any prior versions of this document.

© 2017 STMicroelectronics – All rights reserved