

500-kHz Half-Bridge DC/DC Controller with Integrated Secondary Synchronous Rectification Drivers

DESCRIPTION

Si9122E is a half-bridge controller IC ideally suited to fixed telecom applications where high efficiency is required at low output voltages (e.g. < 3.3 V). Designed to operate within the fixed telecom voltage range of 36 V to 75 V, the IC is capable of controlling and driving both the low and high-side switching devices of a half bridge circuit and also controlling the switching devices on the secondary side of the bridge. Due to the very low on-resistance of the secondary MOSFETs, a significant increase in conversion efficiency can be achieved as compared with conventional Schottky diodes. Control of the secondary devices is by means of a pulse transformer and a pair of inverters. Such a system has efficiencies well in excess of 90 % even for low output voltages.

On-chip control of the dead time delays between the primary and secondary synchronous signals keep efficiencies high and prevent shorting of the power transformer. An external resistor sets the oscillator frequency from 200 kHz to 500 kHz.

Si9122E has advanced current monitoring and control circuitry which allow the user to set the maximum current in the primary circuit. Such a feature acts as protection against output shorting and also provides constant current into large capacitive loads during start-up or when paralleling power supplies. Current sensing is by means of a sense resistor on the low-side primary device.

FEATURES

- 92 % primary/secondary duty cycle
- 135 °C over temperature protection
- Compatible with ETSI 300 132-2
- 28 V to 75 V input voltage range
- Integrated ± 1 A half bridge primary drivers
- Secondary synchronous rectifier control signals with programmable deadtime delay
- Voltage mode control
- Voltage feedforward compensation
- High voltage pre-regulator operates during start-up
- Current sensing on low-side primary device
- Frequency foldback eliminates constant current tail
- Advanced maximum current control during start-up and shorted load
- Low input voltage detection
- Programmable soft-start function



RoHS
COMPLIANT

APPLICATIONS

- Network cards
- Power supply modules
- Distributed power systems
- Intermediate bus converter
- Brick converter

FUNCTIONAL BLOCK DIAGRAM AND PIN CONFIGURATION

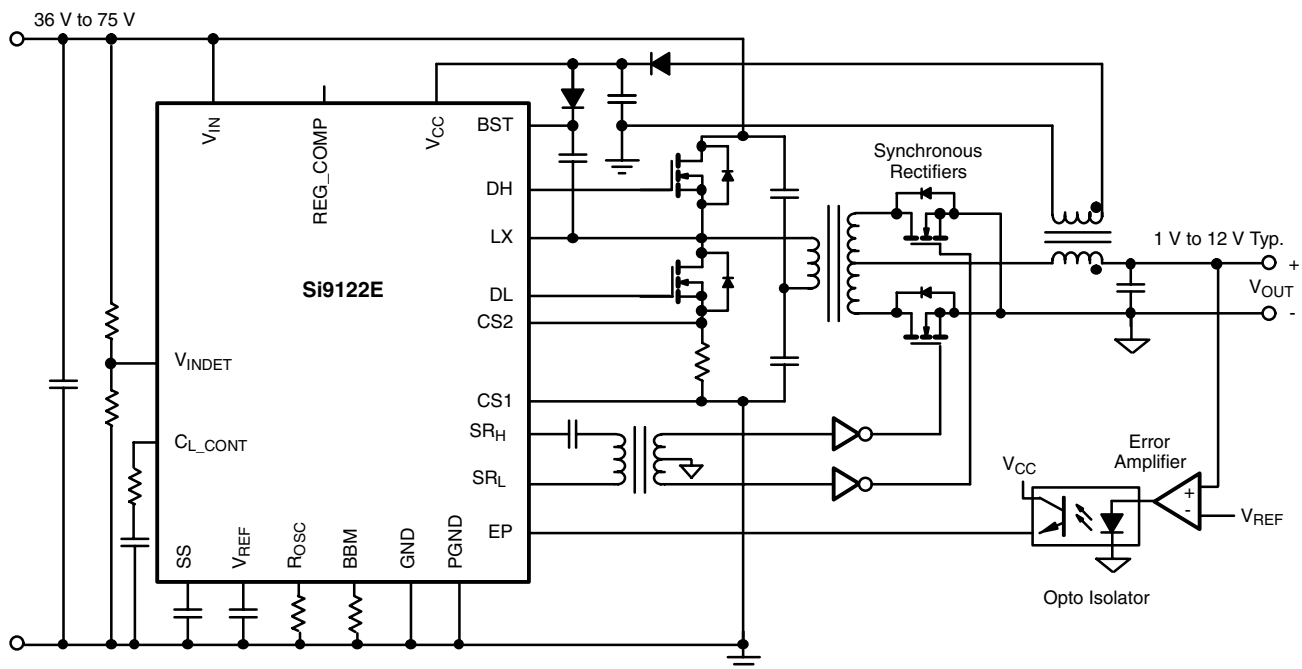

Figure 1.

TECHNICAL DESCRIPTION

Si9122E is a voltage mode controller for the half-bridge topology. With 100 V depletion mode MOSFET, the Si9122E is capable of powering directly from the high voltage bus to V_{CC} through an external PNP pass transistor, or may be powered through an external regulator directly through the V_{CC} pin. With PWM control, Si9122E provides peak efficiency throughout the entire line and load range. In order to simplify the design of efficient secondary synchronous rectification circuitry, the Si9122E provides intelligent gate drive signals to control the secondary MOSFETs. With independent gate drive signals from the controller, transformer design is no longer limited by the gate to source rating of the secondary-side MOSFETs. Si9122E provides constant V_{GS} voltage, independent of the line voltage to minimize the gate charge loss as well as conduction loss.

To prevent shoot-through current or transformer shorting, adjustable Break-Before-Make (BBM) time is incorporated into the IC and is programmed by an external precision resistor.

Si9122E is assembled in lead (Pb)-free TSSOP-20 and MLP65-20 packages. To satisfy stringent ambient temperature requirements, Si9122E is rated to handle the industrial temperature range of $-40\text{ }^{\circ}\text{C}$ to $85\text{ }^{\circ}\text{C}$. When a situation arises which results in a rapid increase in primary (or secondary) current such as output shorted or start-up with a large output capacitor, control of the PWM generator is handed over to the current loop. Monitoring of the load current is by means of an external current sense resistor in the source of the primary low-side switch. With the lower OTP set at $135\text{ }^{\circ}\text{C}$, the DNF20 package improves the thermal headroom.

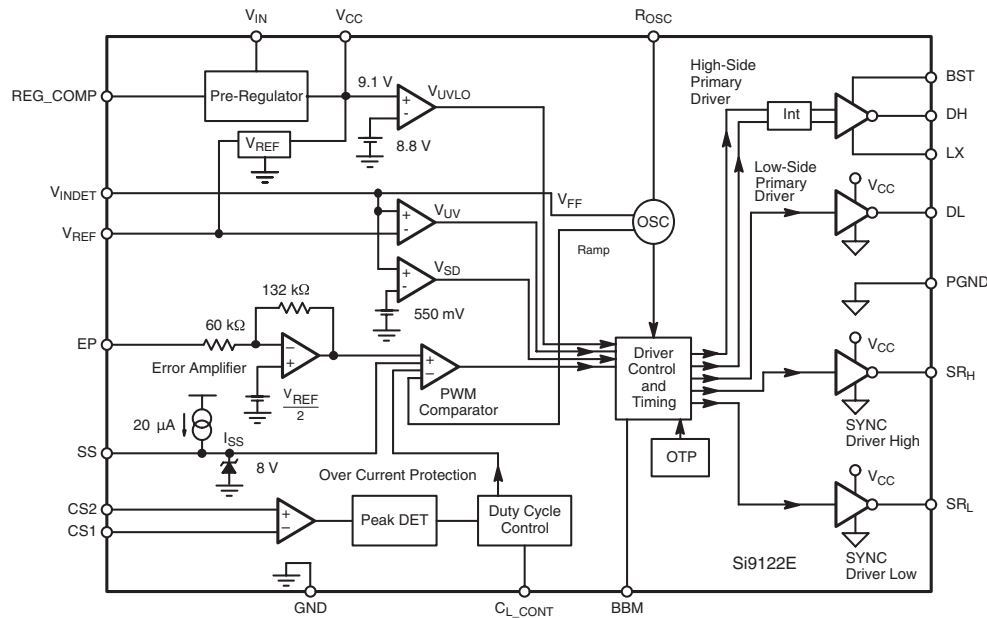

Figure 2.

ABSOLUTE MAXIMUM RATINGS All voltages referenced to GND = 0 V			
Parameter		Limit	Unit
V_{IN} (Continuous)		80	V
V_{IN} (100 ms)		100	
V_{CC}		14.5	
V_{BST}	Continuous	95	
	100 ms	113.2	
V_{LX}		100	
$V_{BST} - V_{LX}$		15	
V_{REF} R_{OSC}		- 0.3 to $V_{CC} + 0.3$	
Logic Inputs		- 0.3 to $V_{CC} + 0.3$	
Analog Inputs		- 0.3 to $V_{CC} + 0.3$	
HV Pre-Regulator Input Current	Continuous	5	mA



ABSOLUTE MAXIMUM RATINGS All voltages referenced to GND = 0 V			
Parameter		Limit	Unit
Storage Temperature		- 65 to 150	°C
Operating Junction Temperature		150	
Power Dissipation ^a	TSSOP-20 ^b	850	mW
	MLP65-20 ^c	2500	
Thermal Impedance (θ_{JA})	TSSOP-20	75	°C/W
	MLP65-20	38	

Notes:

- a. Device mounted on JEDEC compliant 1S2P test board.
- b. Derate 14 mW/°C above 25 °C.
- c. Derate 26 mW/°C above 25 °C.

Stresses beyond those listed under "Absolute Maximum Ratings" may cause permanent damage to the device. These are stress ratings only, and functional operation of the device at these or any other conditions beyond those indicated in the operational sections of the specifications is not implied. Exposure to absolute maximum rating conditions for extended periods may affect device reliability.

RECOMMENDED OPERATING RANGE All voltages referenced to GND = 0 V			
Parameter		Limit	Unit
V_{IN}		36 to 75	V
V_{CC}		10.5 to 13.2	
CV_{CC}		≥ 4.7	μF
f_{OSC}		200 to 500	kHz
R_{OSC}		30 to 72	kΩ
R_{BBM}		22 to 50	
C_{REF}		0.1	μF
C_{BOOST}		0.1	
Analog Inputs		0 to $V_{CC} - 2$	V
Digital Inputs		0 to V_{CC}	
Reference Voltage Output Current		0.1 to 2.5	mA

SPECIFICATIONS^a						
Parameter	Symbol	Test Conditions Unless Otherwise Specified $f_{NOM} = 500$ kHz, $V_{IN} = 75$ V $V_{INDET} = 7.5$ V; 10.5 V ≤ V_{CC} ≤ 13.2 V	Limits - 40 to 85 °C			Unit
			Min. ^b	Typ. ^c	Max. ^b	
Reference (3.3 V)						
Output Voltage	V_{REF}	$V_{CC} = 12$ V, 25 °C Load = 0 mA	3.2	3.3	3.4	V
Short Circuit Current	I_{SREF}	$V_{REF} = 0$ V			- 50	mA
Load Regulation	dVr/dir	$I_{REF} = 0$ to - 2.5 mA		- 30	- 75	mV
Power Supply Rejection	PSRR	at 100 Hz		60		dB
Oscillator						
Accuracy (1 % R_{OSC})		$R_{OSC} = 30$ kΩ, $f_{NOM} = 500$ kHz	- 20		20	%
Max Frequency ^g	F_{MAX}	$R_{OSC} = 22.6$ kΩ	400	500	600	kHz
Foldback Frequency ^d	F_{FOBK}	$f_{NOM} = 500$ kHz, $V_{CS2} - V_{CS1} > 150$ mV		100		
Error Amplifier						
Input Bias Current	I_{BIAS}	$V_{EP} = 0$ V	- 40		- 15	μA
Gain	A_V			- 2.2		V/V
Bandwidth	BW			5		MHz
Power Supply Rejection	PSRR	at 110 Hz		60		dB
Slew State	SR			0.5		V/μs

SPECIFICATIONS ^a								
Parameter	Symbol	Test Conditions Unless Otherwise Specified $f_{\text{NOM}} = 500 \text{ kHz}$, $V_{\text{IN}} = 75 \text{ V}$ $V_{\text{INDET}} = 7.5 \text{ V}$; $10.5 \text{ V} \leq V_{\text{CC}} \leq 13.2 \text{ V}$		Limits - 40 to 85 °C			Unit	
				Min. ^b	Typ. ^c	Max. ^b		
Current Sense Amplifier								
Input Voltage CM Range	V_{CM}	$V_{\text{CS1}} - \text{GND}$, $V_{\text{CS2}} - \text{GND}$			± 150		mV	
Current Sense Amplifier								
Input Amplifier Gain	A_{VOL}				17.5		dB	
Input Amplifier Bandwidth	BW				5		MHz	
Input Amplifier Offset Voltage	V_{OS}				± 5		mV	
$C_{\text{L_CONT}}$ Current	$I_{\text{CL_CONT}}$	$dV_{\text{CS}} = 0$			120		μA	
		$dV_{\text{CS}} = 100 \text{ mV}$			0			
		$dV_{\text{CS}} = 100 \text{ mV}$			> 2		mA	
Lower Current Limit Threshold	V_{TLCL}	$I_{\text{PD}} = I_{\text{PU}} - I_{\text{CL_CONT}} = 0$			100		mV	
Upper Current Limit Threshold	V_{THCL}	$I_{\text{PD}} > 2 \text{ mA}$			150			
Hysteresis		$I_{\text{PU}} < 500 \mu\text{A}$			- 50			
$C_{\text{L_CONT}}$ Clamp Level	$C_{\text{L_CONT}}$	$I_{\text{PU}} = 500 \mu\text{A}$		0.6		1.5	V	
PWM Operation								
Duty Cycle	D_{MAX}	$f_{\text{OSC}} = 500 \text{ kHz}$, $25 \text{ }^\circ\text{C}$ $V_{\text{INDET}} = 4.8 \text{ V}$, $V_{\text{IN}} = 48 \text{ V}$	$V_{\text{EP}} = 0 \text{ V}$	Primary	88	91	94	%
				Secondary	90	93	95	%
	D_{MIN}		$V_{\text{EP}} = 1.75 \text{ V}$				< 17	
		$V_{\text{CS2}} - V_{\text{CS1}} > 150 \text{ mV}$				3		
Pre-Regulator								
Input Voltage	$+ V_{\text{IN}}$	$I_{\text{IN}} = 10 \mu\text{A}$		36		75	V	
Input Leakage Current	I_{LKG}	$V_{\text{IN}} = 75 \text{ V}$, $V_{\text{CC}} > V_{\text{REG}}$				10	μA	
Regulator Bias Current	I_{REG1}	$V_{\text{IN}} = 75 \text{ V}$, $V_{\text{INDET}} < V_{\text{SD}}$			86	200		
	I_{REG2}	$V_{\text{IN}} = 75 \text{ V}$, $V_{\text{INDET}} > V_{\text{REF}}$			8	14	mA	
Regulator_Comp	I_{SOURCE}	$V_{\text{CC}} = 12 \text{ V}$		- 29	- 19	- 9	μA	
	I_{SINK}			50	82	110		
Pre-Regulator drive Capability	I_{START}	$V_{\text{CC}} < V_{\text{REG}}$		20			mA	
V_{CC} Pre-Regulator Turn Off Threshold Voltage	V_{REG1}	$V_{\text{INDET}} > V_{\text{REF}}$	$T_{\text{A}} = 25 \text{ }^\circ\text{C}$	7.4	9.1	10.4	V	
	V_{REG2}			$V_{\text{INDET}} = 0 \text{ V}$				9.2
Undervoltage Lockout	V_{UVLO}	V_{CC} Rising	$T_{\text{A}} = 25 \text{ }^\circ\text{C}$	7.15	8.8	9.8		
				8.1	8.8	9.3		
V_{ULVO} Hysteresis ^f	V_{UVLOHYS}				0.5			
Soft-Start								
Soft-Start Current Output	I_{SS}	Start-Up Condition		12	20	28	μA	
Soft-Start Completion Voltage	$V_{\text{SS_COMP}}$	Normal Operation		7.35	8.05	8.85	V	
Shutdown								
V_{INDET} Shutdown	V_{SD}	V_{INDET} Rising		350	550	720	mV	
V_{SD} Hysteresis		V_{INDET} Falling			200			
V_{INDET} Input Threshold Protection								
$V_{\text{INDET}} - V_{\text{IN}}$ Under Voltage	V_{UV}	V_{INDET} Rising		3.13	3.3	3.46	V	
V_{UV} Hysteresis		V_{INDET} Falling		0.23	0.3	0.35		
Over Temperature Voltages								
Activating Temperature	OTP_on	T_{J} Increasing			135		$^\circ\text{C}$	
De-Activating Temperature	OTP_off	T_{J} Decreasing			113			



SPECIFICATIONS^a						
Parameter	Symbol	Test Conditions Unless Otherwise Specified $f_{NOM} = 500 \text{ kHz}$, $V_{IN} = 75 \text{ V}$ $V_{INDET} = 7.5 \text{ V}$; $10.5 \text{ V} \leq V_{CC} \leq 13.2 \text{ V}$	Limits - 40 to 85 °C			Unit
			Min. ^b	Typ. ^c	Max. ^b	
Converter Supply Current (V_{CC})						
Shutdown	I_{CC1}	Shutdown, $V_{INDET} = 0 \text{ V}$	50		350	μA
Converter Supply Current (V_{CC})						
Switching Disabled	I_{CC2}	$V_{INDET} < V_{REF}$	4	8	12	mA
Switching w/o Load	I_{CC3}	$V_{INDET} > V_{REF}$, $f_{NOM} = 500 \text{ kHz}$	5	10	15	
Switching with C_{LOAD}	I_{CC4}	$V_{CC} = 12 \text{ V}$, $C_{DH} = C_{DL} = 3 \text{ nF}$ $C_{SRH} = C_{SRL} = 0.3 \text{ nF}$		21		
Output MOSFET DH Driver (High-Side)						
Output High Voltage	V_{OH}	Sourcing 10 mA	$V_{BST} - 0.3$			V
Output Low Voltage	V_{OL}	Sinking 10 mA			$V_{LX} + 0.3$	
Boost Current	I_{BST}	$V_{LX} = 48 \text{ V}$, $V_{BST} = V_{LX} + V_{CC}$	1.3	1.9	2.7	mA
LX Current	I_{LX}	$V_{LX} = 48 \text{ V}$, $V_{BST} = V_{LX} + V_{CC}$	- 1.3	- 0.7	- 0.4	
Peak Output Source	I_{SOURCE}	$V_{CC} = 10.5 \text{ V}$		- 1.0	- 0.75	A
Peak Output Sink	I_{SINK}		0.75	1.0		
Rise Time	t_r	$C_{DH} = 3 \text{ nF}$		35		ns
Fall Time	t_f			35		
Output MOSFET DL Driver (Low-Side)						
Output High Voltage	V_{OH}	Sourcing 10 mA	$V_{CC} - 0.3$			V
Output Low Voltage	V_{OL}	Sinking 10 mA			0.3	
Peak Output Source	I_{SOURCE}	$V_{CC} = 10.5 \text{ V}$		- 1.0	- 0.75	A
Peak Output Sink	I_{SINK}		0.75	1.0		
Rise Time	t_r	$C_{DH} = 3 \text{ nF}$		35		ns
Fall Time	t_f			35		
Synchronous Rectifier (SR_H, SR_L) Drivers						
Output High Voltage	V_{OH}	Sourcing 10 mA	$V_{CC} - 0.4$			V
Output Low Voltage	V_{OL}	Sinking 10 mA			0.4	
Break-Before-Make Time ^e	t_{BBM1}	$T_A = 25 \text{ }^\circ\text{C}$, $R_{BBM} = 33 \text{ k}\Omega$, $V_{INDET} = 4.8 \text{ V}$, $V_{EP} = 0 \text{ V}$, $V_{IN} = 48 \text{ V}$		48		ns
	t_{BBM2}			9		
	t_{BBM3}	$T_A = 25 \text{ }^\circ\text{C}$, $R_{BBM} = 33 \text{ k}\Omega$, $BST = 60 \text{ V}$, $V_{INDET} = 4.8 \text{ V}$, $V_{EP} = 0 \text{ V}$, $V_{IN} = 48 \text{ V} = LX$		24		
	t_{BBM4}			18		
Peak Output Source	I_{SOURCE}	$V_{CC} = 10.5 \text{ V}$		- 100		mA
Peak Output Sink	I_{SINK}			100		
Rise Time	t_r	$C_{DH} = 3 \text{ nF}$		35		ns
Fall Time	t_f			35		
Voltage Mode						
Error Amplifier	t_{d1DH}	Input to High-Side Switch Off		< 200		ns
	t_{d2DL}	Input to Low-Side Switch Off		< 200		
Current Mode						
Current Amplifier	t_{d3DH}	Input to High-Side Switch Off		< 200		ns
	t_{d4DL}	Input to Low-Side Switch Off		< 200		

Notes:

- a. Refer to PROCESS OPTION FLOWCHART for additional information.
- b. The algebraic convention whereby the most negative value is a minimum and the most positive a maximum (- 40 °C to 85 °C).
- c. Typical values are for DESIGN AID ONLY, not guaranteed nor subject to production testing.
- d. F_{MIN} when V_{CL_CONT} at clamp level. Typical foldback frequency change + 20 %, - 30 % over temperature.
- e. See Figure 3 for Break-Before-Make time definition.
- f. V_{UVLO} tracks V_{REG1} by a diode drop.
- g. Guaranteed by design and characterization, not tested in production.

TIMING DIAGRAM FOR MOS DRIVERS

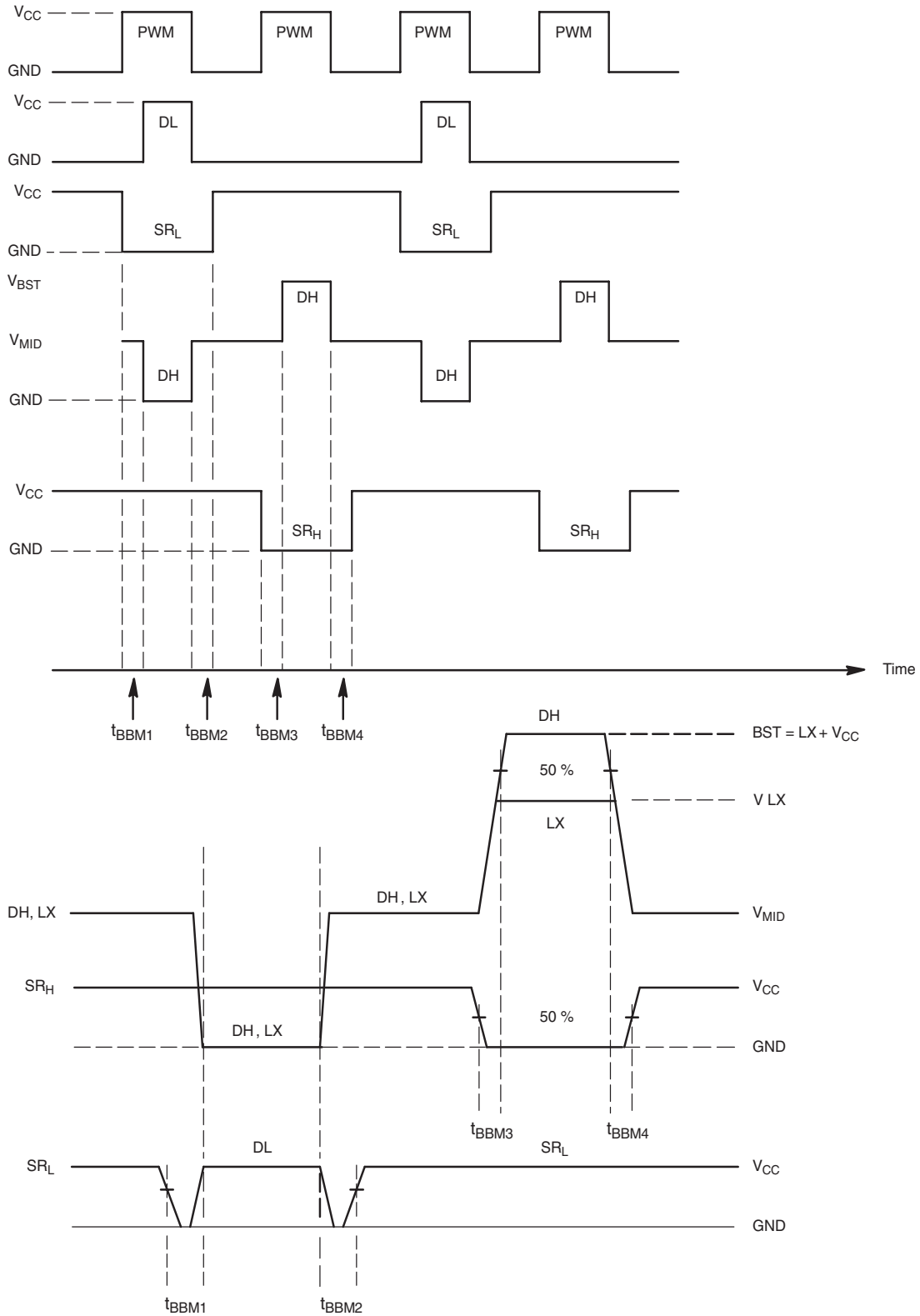
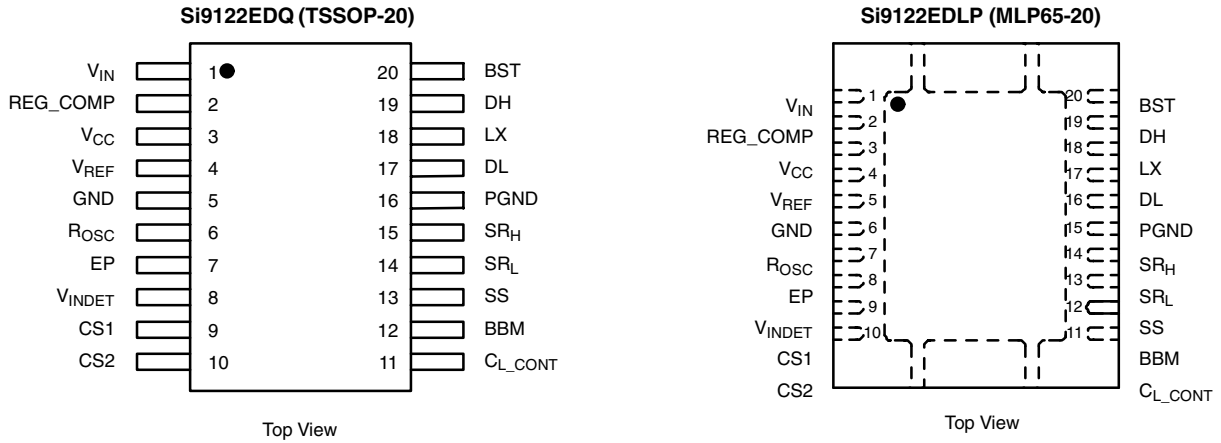

Figure 3.

PIN CONFIGURATION



ORDERING INFORMATION		
Part Number	Temperature Range	Package
Si9122EDQ-T1-E3	- 40 °C to 85 °C	TSSOP-20
Si9122EDLP-T1-E3		MLP65-20

Eval Board	Temperature Range	Board Type
Contact Factory	- 10 °C to 70 °C	Surface Mount and Thru-Hole

PIN DESCRIPTION		
1	V_{IN}	Input supply voltage for the start-up circuit
2	REG_COMP	Control signal for an external pass transistor
3	V_{CC}	Supply voltage for internal circuitry
4	V_{REF}	3.3 V reference
5	GND	Ground
6	R_{OSC}	External resistor connection to oscillator
7	EP	Voltage control input
8	V_{INDET}	V_{IN} under voltage detect and shutdown function input. Shuts down or disables switching when V_{INDET} falls below preset threshold voltages and provides the feed forward voltage.
9	CS1	Current limit amplifier negative input
10	CS2	Current limit amplifier positive input
11	C_{L_CONT}	Current limit compensation
12	BBM	Programmable Break-Before-Make time connection to an external resistor to set time delay
13	SS	Soft-Start control - external capacitor connection
14	SR_L	Signal transformer drive, sequenced with the primary side.
15	SR_H	Signal transformer drive, sequenced with the primary side
16	PGND	Power ground
17	DL	Low-side gate drive signal - primary
18	LX	High-side source and transformer connection node
19	DH	High-side gate drive signal - primary
20	BST	Bootstrap voltage to drive the high-side n-channel MOSFET switch

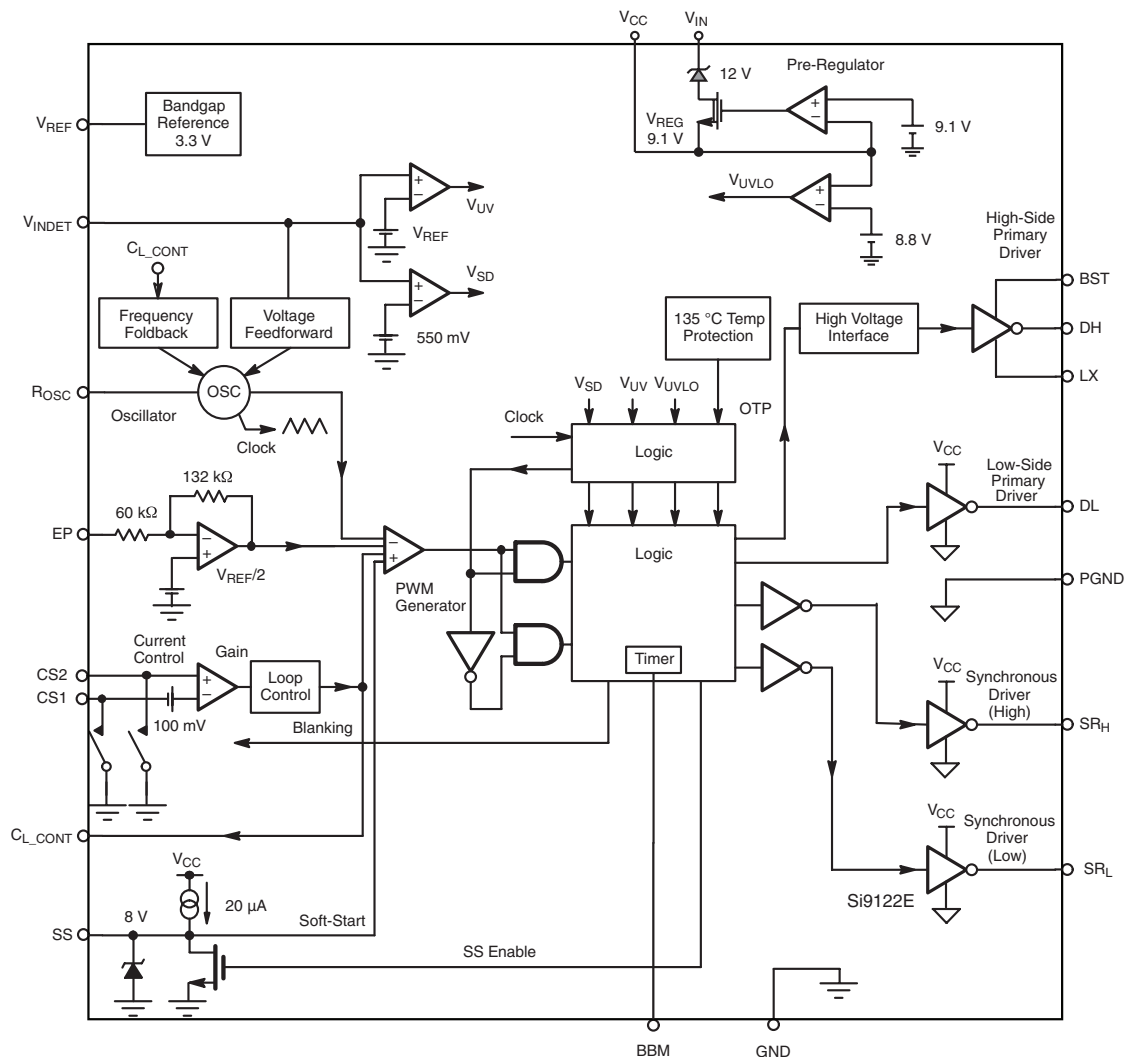

Figure 4. Detailed Si9122E Block Diagram

DETAILED OPTION

Start-Up

When V_{INEXT} rises above 0 V, the internal pre-regulator begins to charge up the V_{CC} capacitor. Current into the external V_{CC} capacitor is limited to typically 40 mA by the internal DMOS device. When V_{CC} exceeds the UVLO voltage of 8.8 V a soft-start cycle of the switch mode supply is initiated. The V_{CC} supply continues to be charged by the pre-regulator until V_{CC} equals V_{REG} . During this period, between V_{UVLO} and V_{REG} , excessive load current will result in V_{CC} falling below V_{UVLO} and stopping switch mode operation. This situation is avoided by the hysteresis between V_{REG} and V_{UVLO} and correct sizing of the V_{CC} capacitor, bootstrap capacitor and the soft-start capacitor. The value of the V_{CC} capacitor should therefore be chosen to be capable of maintaining switch mode operation until the required V_{CC} current can be supplied from the external circuit (e.g via a power transformer winding and zener regulator). Feedback from the output of the switch mode supply charges V_{CC} above V_{REG} and fully disconnects the pre-regulator,

isolating V_{CC} from V_{IN} . V_{CC} is then maintained above V_{REG} for the duration of switch mode operation. In the event of an over voltage condition on V_{CC} , an internal voltage clamp turns on at 14.5 V to shunt excessive current to GND. Care needs to be taken if there is a delay prior to the external circuit feeding back to the V_{CC} supply. To prevent excessive power dissipation within the IC it is advisable to use an external PNP device. A pin has been incorporated on the IC, (REG_COMP) to provide compensation when employing the external device. In this case the V_{IN} pin is connected to the base of the PNP device and controls the current, while the REG_COMP pin determines the frequency compensation of the circuit. The value of the REG_COMP capacitor cannot be too big, otherwise it will slow down the response of the pre-regulator in the case that fault situations occur and pre-regulator needs to be turned on again. To understand the operation, please refer to figure 5.

The soft-start circuit is designed for the dc-dc converter to start-up in an orderly manner and reduce component stresses on the Converter. This feature is programmable by selecting an external C_{SS} . An internal 20 μA current source charges C_{SS} from 0 V to the final clamped voltage of 8 V. In the event of UVLO or shutdown, V_{SS} will be held low ($< 1\text{ V}$) disabling driver switching. To prevent oscillations, a longer soft-start time may be needed for highly capacitive loads and/or high peak output current applications.

Reference

The reference voltage of Si9122E is set at 3.3 V. The reference voltage should be de-coupled externally with 0.1 μF capacitor. The V_{REF} voltage is 0 V in shutdown mode and has 50 mA source capability.

Voltage Mode PWM Operation

Under normal load conditions, the IC operates in voltage mode and generates a fixed frequency pulse width modulated signal to the drivers. Duty cycle is controlled over a wide range to maintain output voltage under line and load variation. Voltage feedforward is also included to take account of variations in supply voltage V_{IN} .

In the half-bridge topology requiring isolation between output and input, the reference voltage and error amplifier must be supplied externally, usually on the secondary side. The error information is thus passed to the power controller through an opto-coupling device. This information is inverted, hence 0 V represents the maximum duty cycle, while 2 V represents minimum duty cycle. The error information enters the IC via pin EP, and is passed to the PWM generator via an inverting amplifier. The relationship between Duty cycle and V_{EP} is shown in the Typical Characteristic Graph, Duty Cycle vs. V_{EP} 25 $^{\circ}\text{C}$, page 12. Voltage feedforward is implemented by taking the attenuated V_{IN} signal at V_{INDET} and directly modulating the duty cycle.

At start-up, i.e., once V_{CC} is greater than V_{UVLO} , switching is initiated under soft-start control which increases primary switch on-times linearly from D_{MIN} to D_{MAX} over the soft-start period. Start-up from a V_{INDET} power down is also initiated under soft-start control.

Half Bridge and Synchronous Rectification Timing Sequence

The PWM signal generated within the Si9122E controls the low and high-side bridge drivers on alternative cycles. A period of inactivity always results after initiation of the soft-start cycle until the soft-start voltage reaches approximately 1.2 V and PWM controlled switching begins. The first bridge driver to switch is always the low-side (DL), as this allows charging of the high-side boost capacitor.

The timing and coordination of the drives to the primary and secondary stages is very important and shown in figure 3. It is essential to avoid the situation where both of the secondary MOSFETs are on when either the high or the low-side switch are active. In this situation the transformer would effectively be presented with a short across the output. To

avoid this, a dedicated break-before-make circuit is included which will generate non-overlapping waveforms for the primary and the secondary drive signals. This is achieved by a programmable timer which delays the on switching of the primary driver relative to the off switching of the related secondary and subsequently delays the on switching of the secondary relative to the off switching of the related primary. Typical variations of BBM times with respect to R_{BBM} and other operating parameters are shown on page 14 and 15.

Primary High- and Low-Side MOSFET Drivers

The drive voltage for the low-side MOSFET switch is provided directly from V_{CC} . The high-side MOSFET however requires the gate voltage to be enhanced above V_{IN} . This is achieved by bootstrapping the V_{CC} voltage onto the LX voltage (the high-side MOSFET source). In order to provide the bootstrapping an external diode and capacitor are required as shown on the application schematic. The capacitor will charge up after the low-side driver has turned on. The switch gatedrive signals DH and DL are shown in figure 3.

Secondary MOSFET Drivers

The secondary side MOSFETs are driven from the Si9122E via a center tapped pulse transformer and inverter drivers. The waveforms from SR_H and SR_L are shown in figure 3. Of importance is the relative voltage between SR_H and SR_L , i.e. that which is presented across the primary of the pulse transformer. When both potentials of SR_L and SR_H are equal then by the action of the inverting drivers both secondary MOSFETs are turned on.

Oscillator

The oscillator is designed to operate at a nominal frequency of 500 kHz. The 500 kHz operating frequency allows the converter to minimize the inductor and capacitor size, improving the power density of the converter. The oscillator and therefore the switching frequency is programmable by attaching a resistor to the R_{OSC} pin. Under overload conditions the oscillator frequency is reduced by the current overload protection to enable a constant current to be maintained into a low impedance circuit.

Current Limit

Current mode control providing constant current operation is achieved by monitoring the differential voltage V_{CS} between the CS1 and CS2 pins, which are connected to a current sense resistor on the primary low-side MOSFET. In the absence of an overcurrent condition, V_{CS} is less than lower current limit threshold V_{TLCL} (typical 100 mV); C_{L_CONT} is pulled up linearly via the 120 μA current source (I_{PU}) and both DL and DH switch at half the oscillator set frequency. When a moderate overcurrent condition occurs ($V_{TLCL} < V_{CS} < V_{THCL}$), the C_{L_CONT} capacitor will be discharged at a rate that is proportional to $V_{CS} - 100\text{ mV}$ by the I_{PD} current source. Both driver outputs are in frequency fold-back mode and the switching frequency becomes roughly 20 % of

REDUCTION OF $t_{BBM2,4}$ AT HIGHER f_{osc}

The start of a switching period is defined as the turning point of the oscillator, marked in Figure 7 as A, with the end of a switching period marked as B. For a half bridge, two switching periods are required for both the primary high-side and low-side drivers to operate as shown in Figure 3. For a given oscillator frequency there is a finite time in which all events from equation (1) have to occur. These are t_{dt} dead-time duration which is a function of V_{EP} , t_{pd1} is the propagation delay from the PWM to SR_L (or SR_H) output going low, t_{BBM1} (or t_{BBM3}) rise delay, DL (or DH) primary driver on-time, t_{pd2} is the propagation delay from PWM to DL (or DH) output going low and t_{BBM2} (or t_{BBM4}) fall delay.

Figure 7 shows the switching cycle for the low side primary driver and associated synchronous driver and equation (1) shows the switching time components.

At 500 kHz and maximum duty t_{pd2} is typically 60 ns.

$$T_{switch} = 1/2t_{dt} + t_{pd1} + t_{SRLOFF} + 1/2t_{dt} - t_{pd2} - t_{BBM2} \quad (1)$$

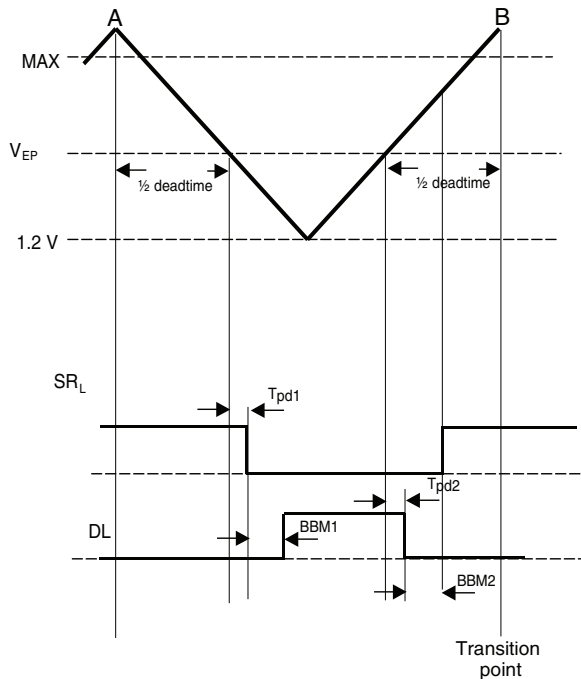

Figure 7. Components of a Low-Side Switching Period

The Si9122E has an improved primary and secondary duty cycles with typical maximum secondary duty at 93.2 %. Hence the dead-time is 6.8 % or 136 ns at 500 kHz. Half of the dead-time is 68 ns and during this time t_{pd2} plus t_{BBM2} has to occur before the next transition point of the oscillator cycle. R_{BBM} contributes 1.2 ns/k Ω to t_{BBM2} ; with 33 k Ω this amounts to 40 ns. If t_{BBM2} is set beyond the transition point, SR_L will be forced high due to logic conditions and a reduction in the set t_{BBM2} will be determined by the half dead-time minus t_{pd2} and will be independent of the R_{BBM} value as shown in figure 8.

Note: this applies to t_{BBM4} as well.

To mitigate the decrease in set t_{BBM2} and t_{BBM4} , the following criteria must be met. The set t_{BBM2} plus its associated t_{pd2} must not exceed 3.4 % of the oscillator period. The typical t_{BBM2} and t_{BBM4} delays are provided in figure 9 to facilitate setting these delays for a given frequency with R_{BBM} of 33 k Ω .

$$t_{BBM2} + t_{pd2} < 3.4 \% \text{ of oscillator period} \quad (2)$$

$$t_{BBM4} + t_{pd4} < 3.4 \% \text{ of oscillator period} \quad (3)$$

It is critical to avoid the condition where the sum of t_{BBM2} (set) and t_{pd2} is greater than 6.8 % of oscillator period whereby the correct sequence of logic signals cannot be guaranteed.

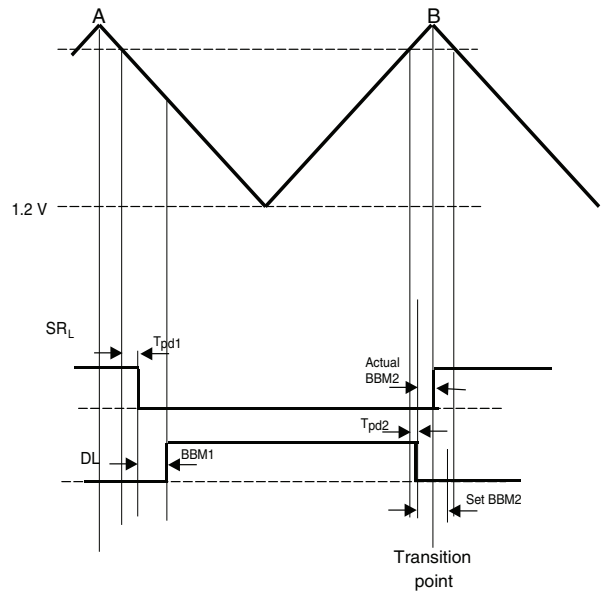

Figure 8. Components of a Low-Side Switching Period with Maximum Duty and Limited t_{BBM2}

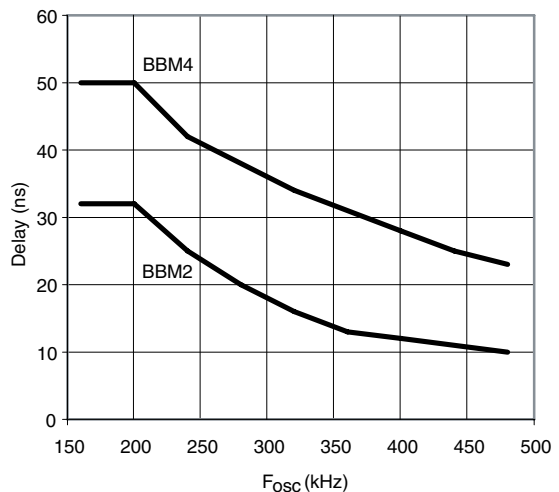
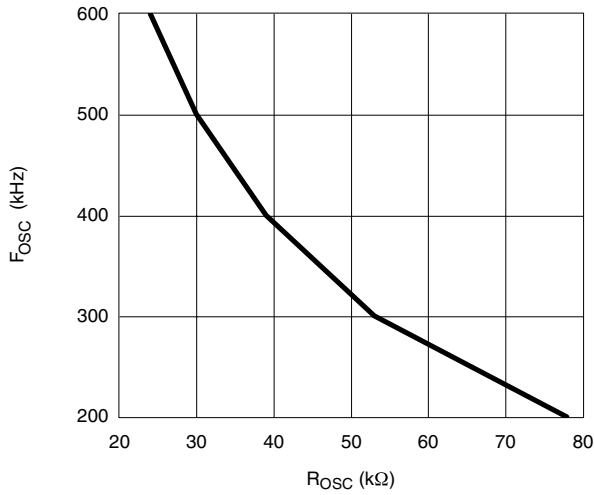
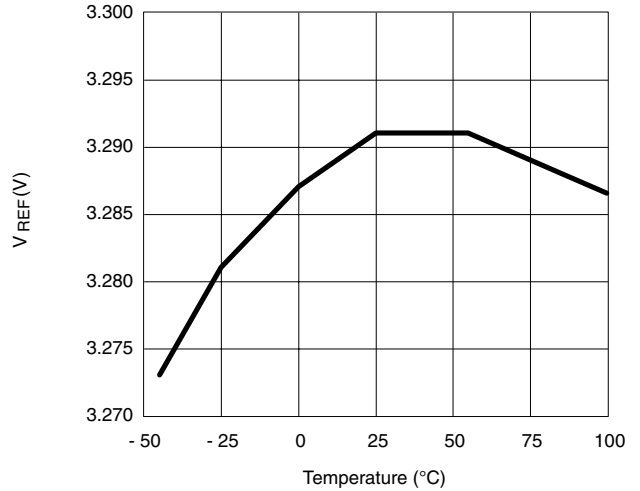

Figure 9. Reduction in t_{BBM2} and t_{BBM4}
Si9122E t_{BBM} vs. F_{osc} ; $V_{IN} = 50$ V, $V_{CC} = 10$ V, $BST = 60$ V, $LX = 50$ V, $V_{EP} = 0$ V

TYPICAL CHARACTERISTICS



Fosc vs. Rosc at V_{CC} = 12 V



V_{REF} vs. Temperature, V_{CC} = 12 V

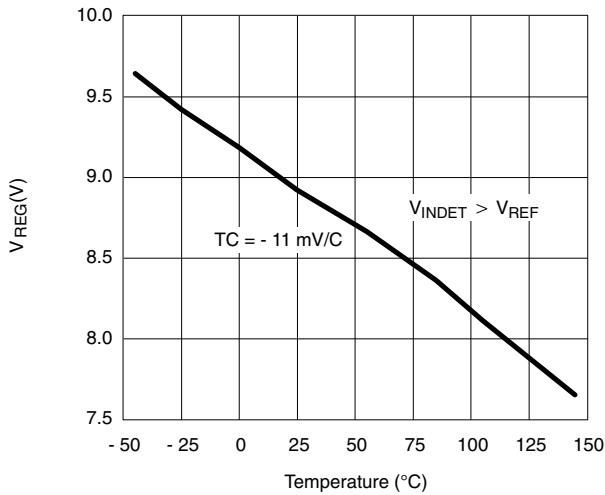

V_{REG} vs. Temperature, V_{IN} = 48 V

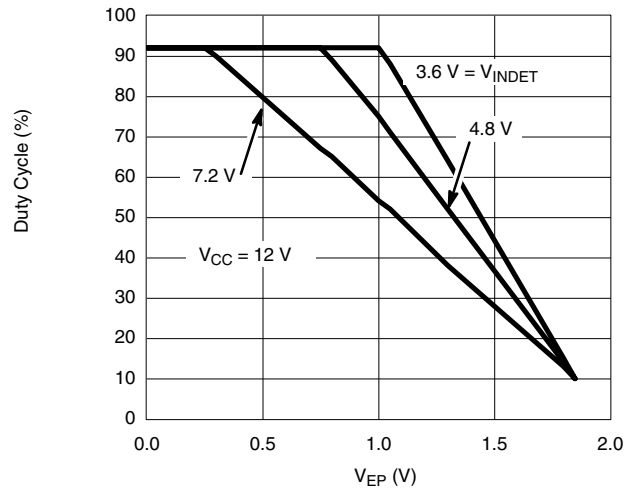

SR_L, SR_H Duty Cycle vs. V_{EP}

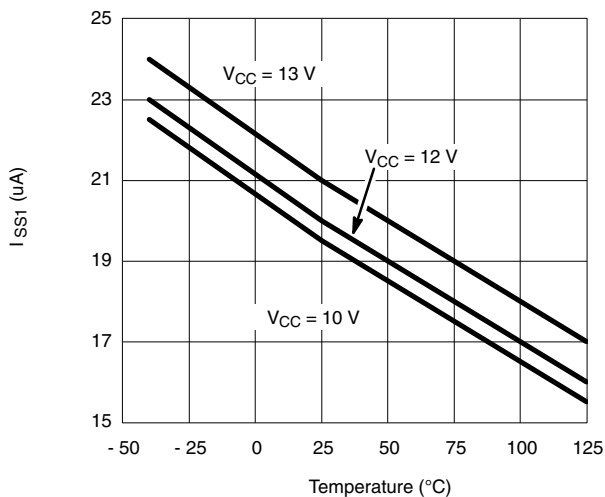

I_{SS} vs. Temperature

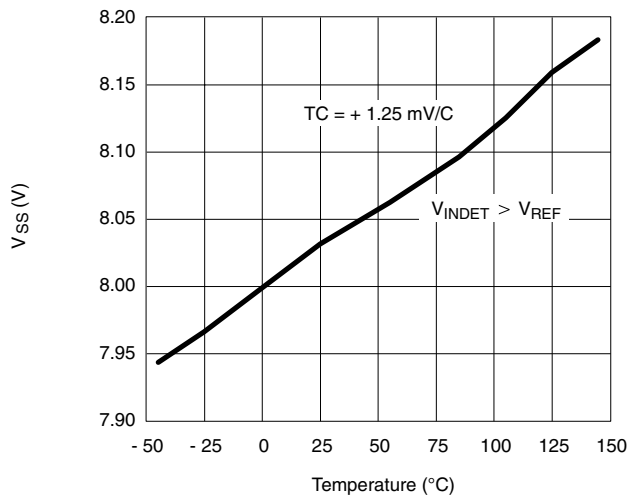

V_{SS} vs. Temperature, V = 12 V

TYPICAL CHARACTERISTICS

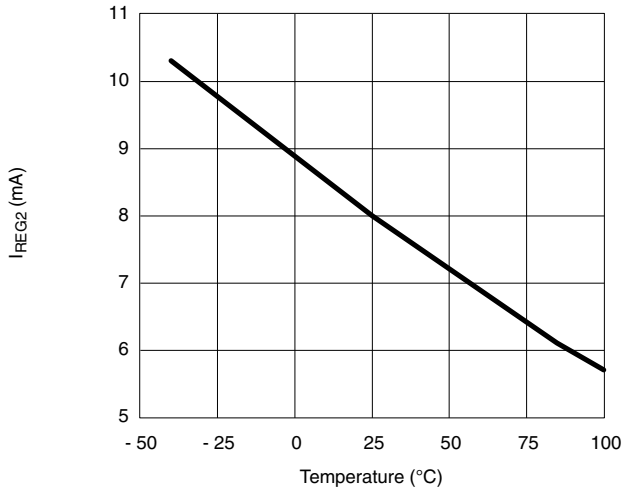

I_{REG2} vs. Temperature, V_{CC} = 12 V

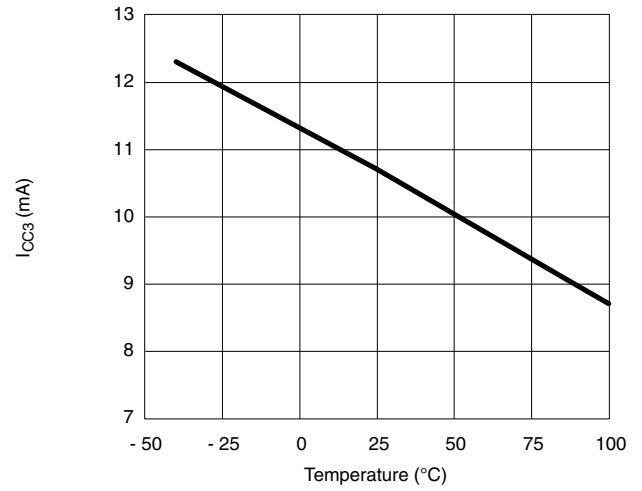

I_{CC3} vs. Temperature, V_{CC} = 12 V

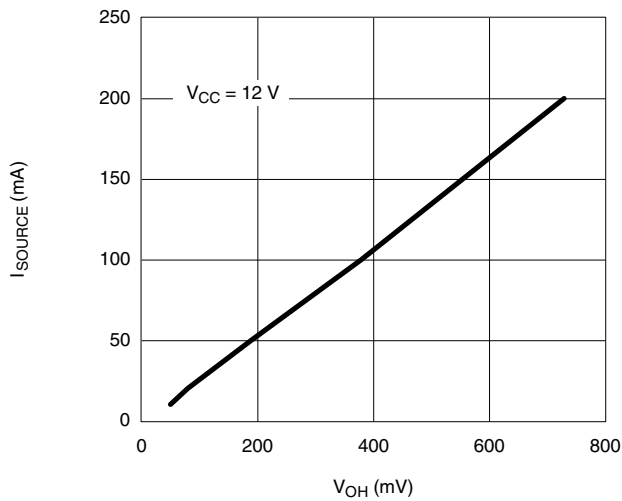

DH, DL I_{SOURCE} vs. V_{OH}

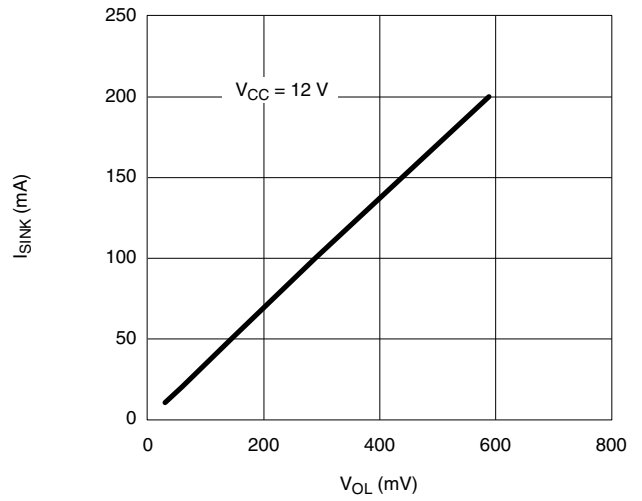

DH, DL I_{SINK} vs. V_{OL}

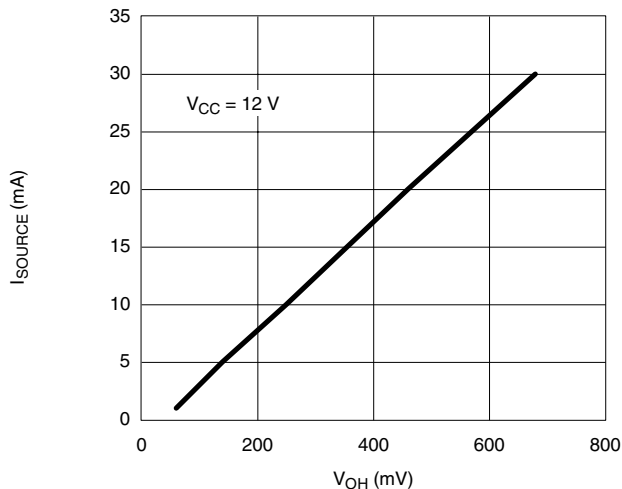

SR_L, SR_H I_{SOURCE} vs. V_{OH}

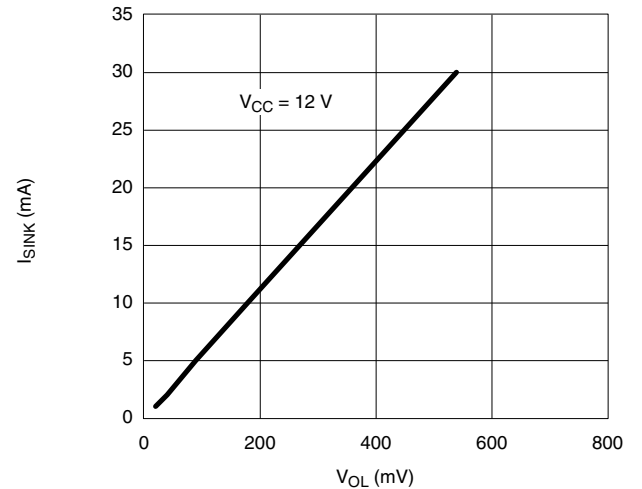

SR_L, SR_H I_{SINK} vs. V_{OL}

TYPICAL CHARACTERISTICS

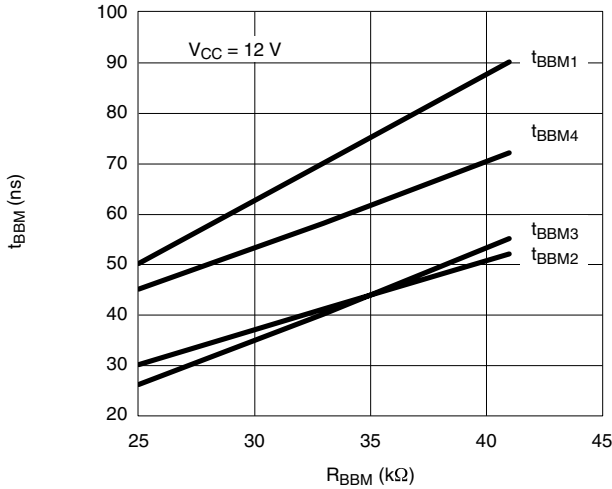

t_{BBM} vs. R_{BBM} , $V_{EP} = 0$ V, $V_{LX} = 48$ V, $BST = 60$ V, $V_{INDET} = 4.8$ V, $f_{OSC} < 200$ kHz

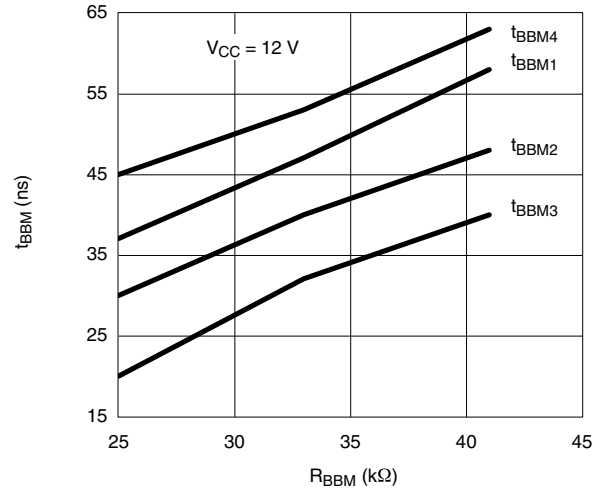

t_{BBM} vs. R_{BBM} , $V_{EP} = 1.65$ V, $V_{LX} = 48$ V, $BST = 60$ V, $V_{INDET} = 4.8$ V

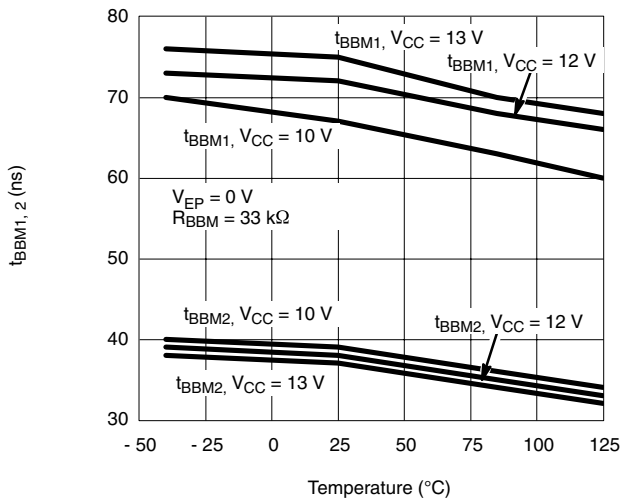

$t_{BBM1,2}$ vs. Temperature, $V_{EP} = 0$ V, $f_{OSC} < 200$ kHz

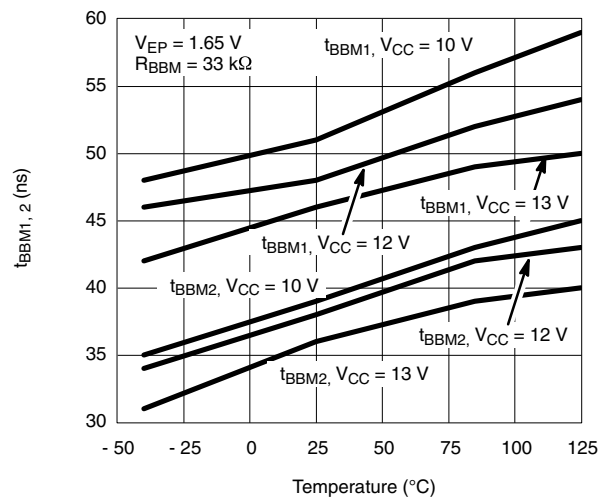

$t_{BBM1,2}$ vs. Temperature, $V_{EP} = 1.65$ V

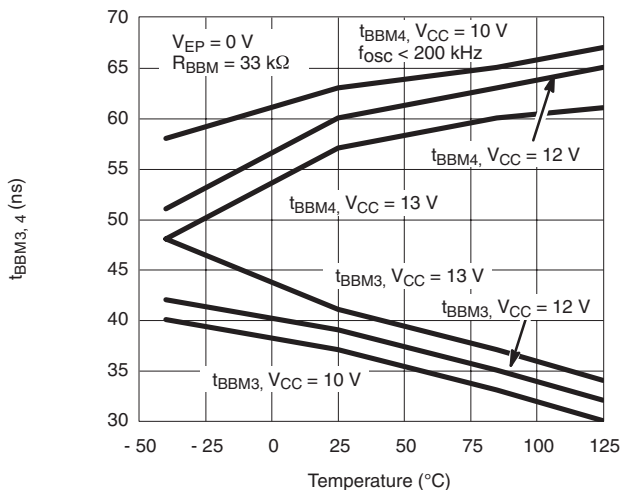

$t_{BBM3,4}$ vs. Temperature, $V_{EP} = 0$ V, $f_{OSC} < 200$ kHz

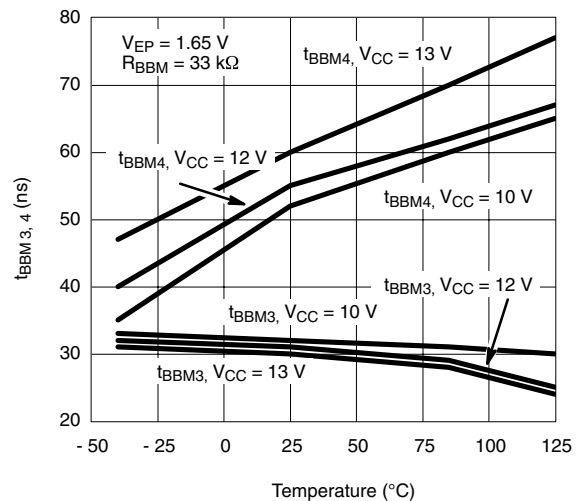

$t_{BBM3,4}$ vs. Temperature, $V_{EP} = 1.65$ V

TYPICAL CHARACTERISTICS

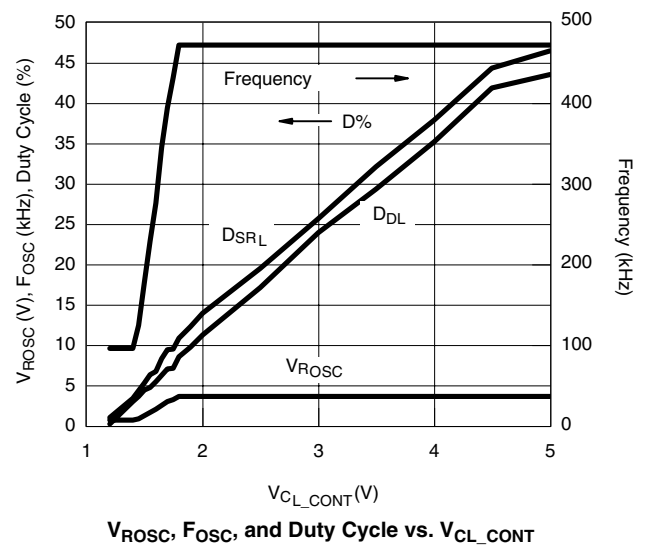
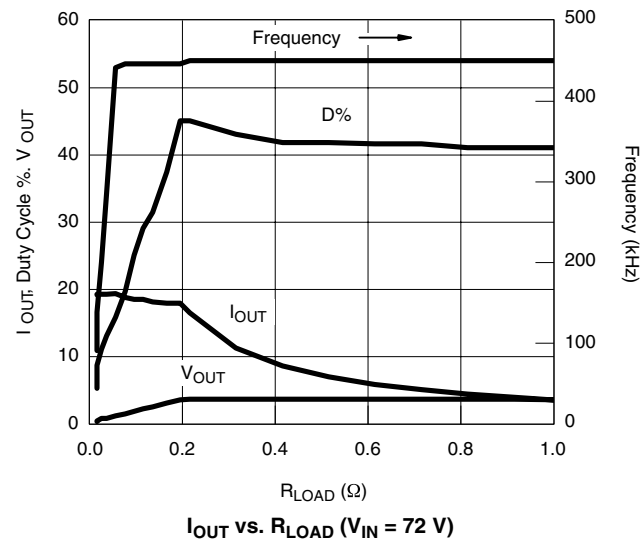
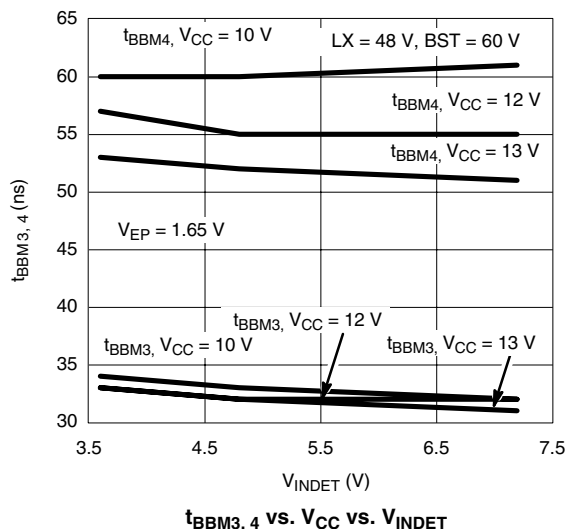
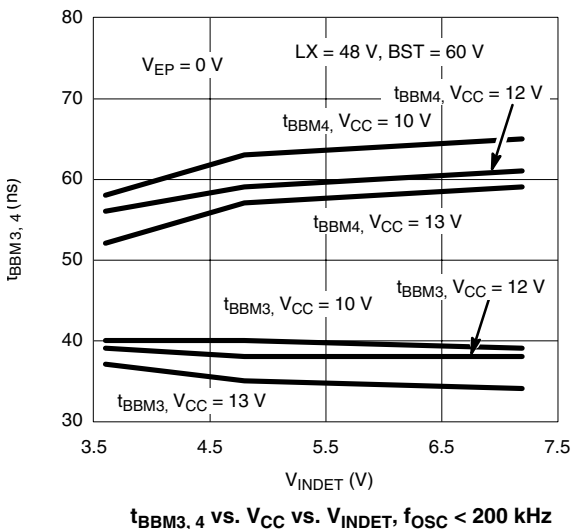
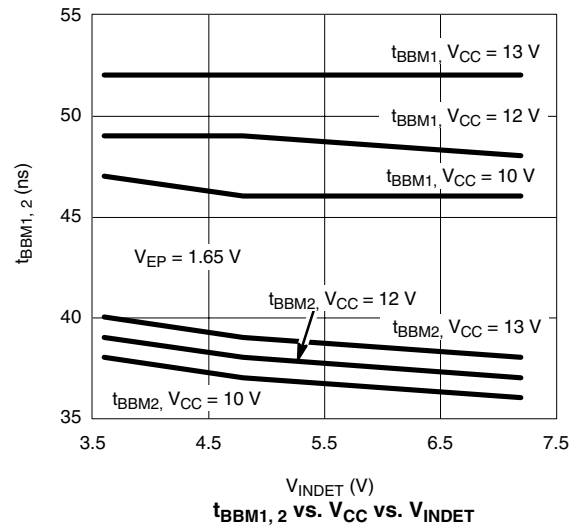
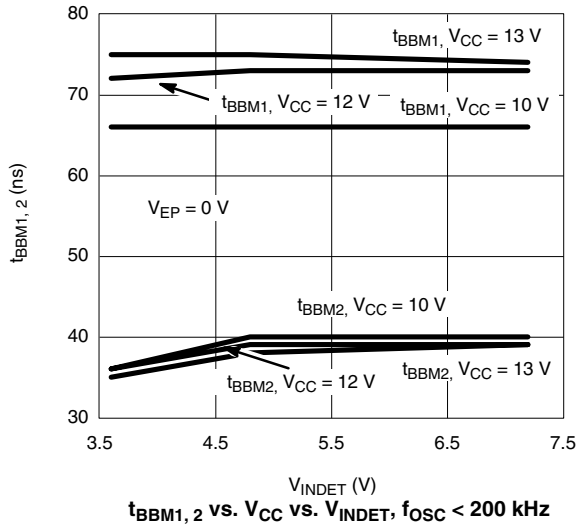

TYPICAL WAVEFORMS

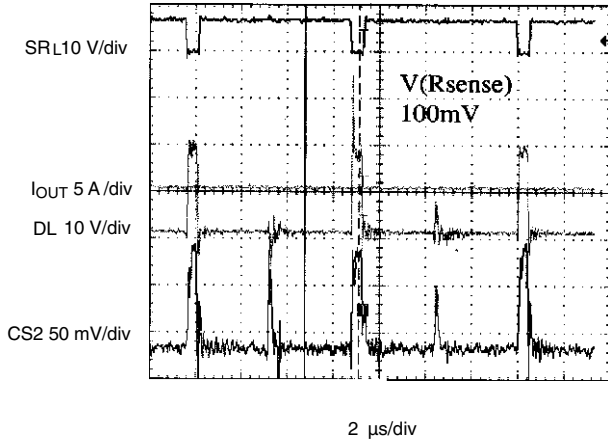

Figure 10. Foldback Mode, $R_L = 0.02 \Omega$

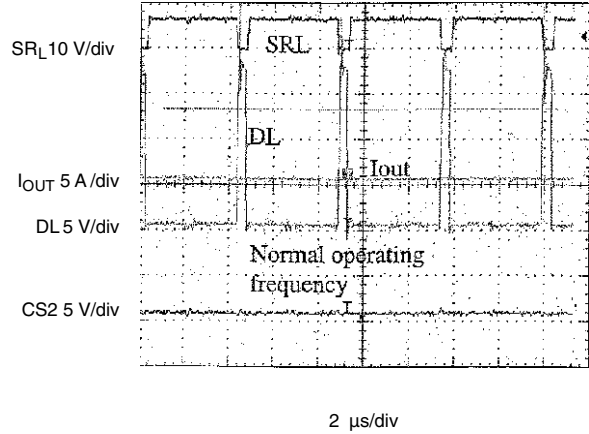

Figure 11. Normal Mode, $R_L = 0.1 \Omega$

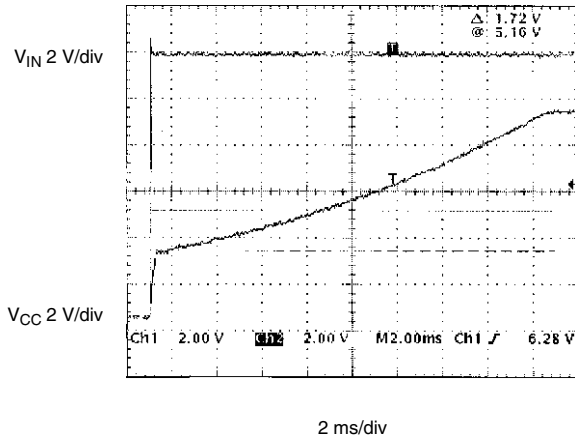

Figure 12. V_{CC} Ramp-Up

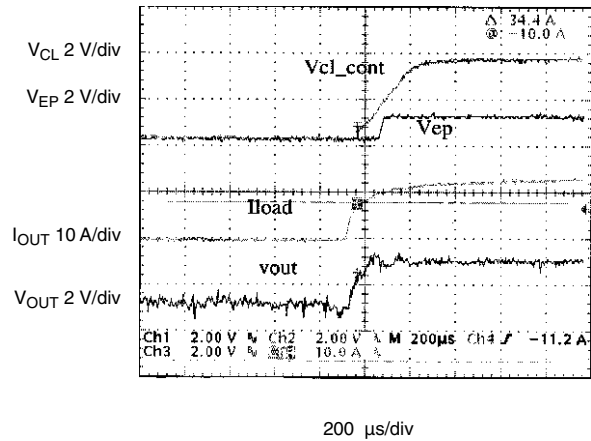

Figure 13. Overload Recovery

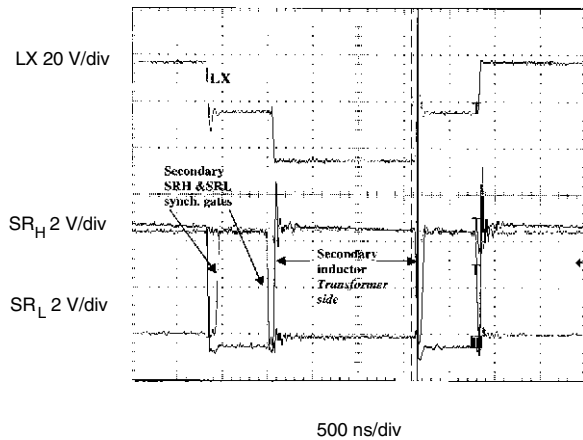

Figure 14. Effective BBM - Measured On Secondary

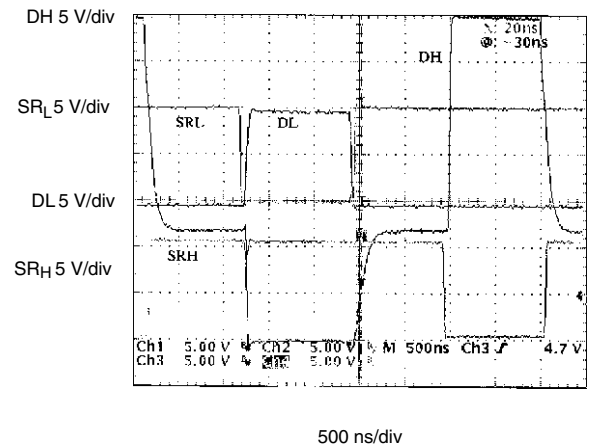
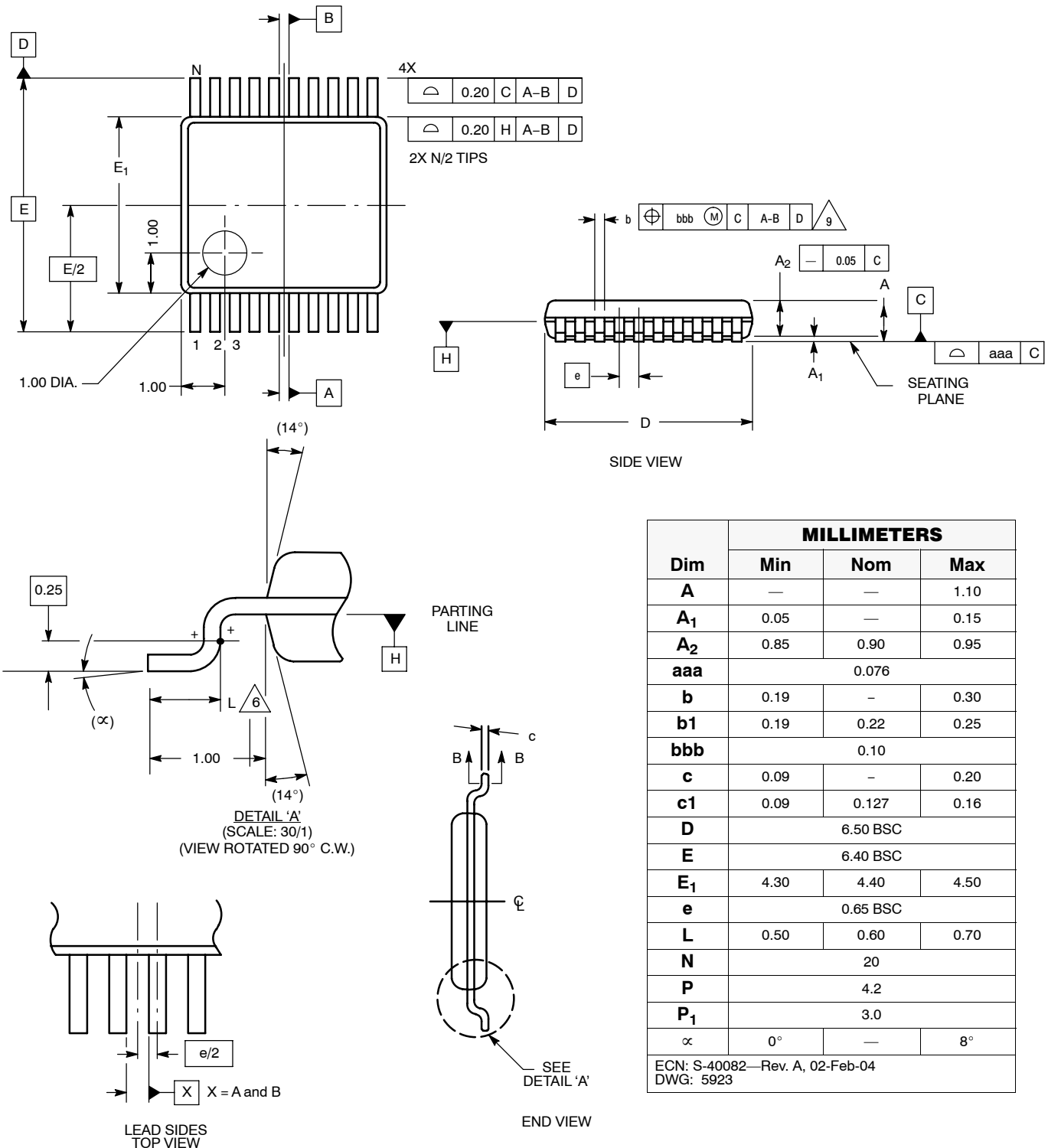

Figure 15. Drive Waveforms

Vishay Siliconix maintains worldwide manufacturing capability. Products may be manufactured at one of several qualified locations. Reliability data for Silicon Technology and Package Reliability represent a composite of all qualified locations. For related documents such as package/tape drawings, part marking, and reliability data, see <http://www.vishay.com/ppg?73866>.

TSSOP: 20-LEAD (POWER IC ONLY)



Dim	MILLIMETERS		
	Min	Nom	Max
A	—	—	1.10
A₁	0.05	—	0.15
A₂	0.85	0.90	0.95
aaa	0.076		
b	0.19	—	0.30
b₁	0.19	0.22	0.25
bbb	0.10		
c	0.09	—	0.20
c₁	0.09	0.127	0.16
D	6.50 BSC		
E	6.40 BSC		
E₁	4.30	4.40	4.50
e	0.65 BSC		
L	0.50	0.60	0.70
N	20		
P	4.2		
P₁	3.0		
α	0°	—	8°
ECN: S-40082—Rev. A, 02-Feb-04 DWG: 5923			



PowerPAK® MLP65-18/20 (POWER IC ONLY)

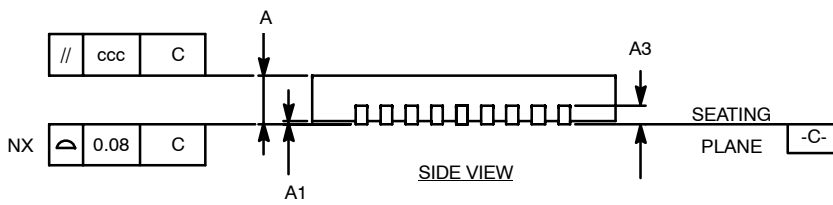
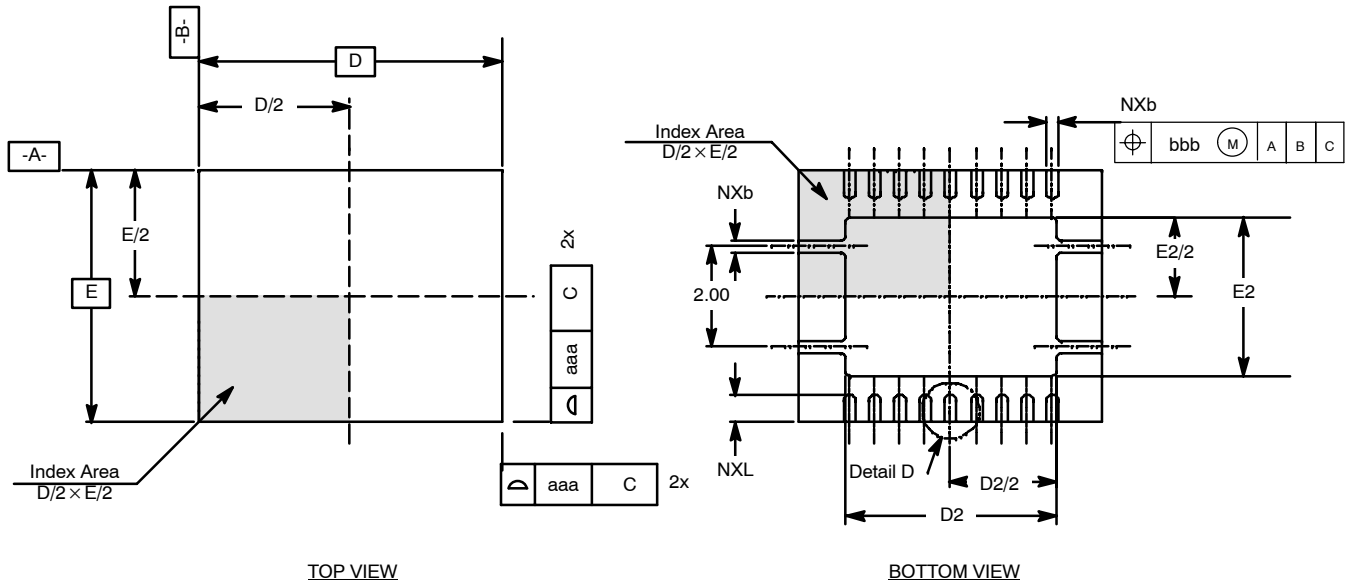



PowerPAK MLP65-18/20 (POWER IC ONLY)

N = 18/20 PITCH: 0.5 mm, BODY SIZE: 6.00 x 5.00

Dim	MILLIMETERS*			INCHES			Notes
	Min	Nom	Max	Min	Nom	Max	
A	0.80	0.90	1.00	0.031	0.035	0.039	1, 2
A1	0.00	0.02	0.05	0.000	0.001	0.002	1, 2
A2	0.00	0.65	1.00	0.000	0.003	0.004	1, 2
A3	0.20 REF			0.008 REF			
aaa	-	0.15	-	-	0.006	-	
b	0.18	0.25	0.30	0.007	0.010	0.012	8
bbb	-	0.10	-	-	0.004	-	
C'	-	0.225	-	-	0.009	-	4, 10
ccc	-	0.10	-	-	0.004	-	
D	6.00 BSC			0.236 BSC			1, 2
D2	4.00	4.15	4.25	0.157	1.63	0.167	1, 2
E	5.00 BSC			0.197 BSC			1, 2
E2	3.00	3.15	3.25	0.118	0.124	0.128	1, 2
e	-	0.50	-	-	0.020	-	
L	0.45	0.55	0.65	0.018	0.022	0.026	1, 2
N	18, 20			18, 20			1, 2
ND(18)	9			9			1, 2
NE(18)	0			0			1, 2
ND(20)	10			10			1, 2
NE(20)	0			0			1, 2

* Use millimeters as the primary measurement.

ECN: S-41946—Rev. A, 18-Oct-04
DWG: 5939

NOTES:

1. Dimensioning and tolerancing conform to ASME Y14.5M-1994.
2. All dimensions are in millimeters. All angles are in degrees.
3. N is the total number of terminals.
4. The terminal #1 identifier and terminal numbering convention shall conform to JEDEC publication 95 SSP-022. Details of terminal #1 identifier are optional, but must be located within the zone indicated. A dot can be marked on the top side by pin 1 to indicate orientation.
5. ND and NE refer to the number of terminals on the D and E side respectively.
6. Depopulation is possible in a symmetrical fashion.
7. NJR refers to NON JEDEC REGISTERED.
8. Dimension "b" applies to metalized terminal and is measured between 0.15 mm and 0.30 mm from the terminal tip. If the terminal has optional radius on the other end of the terminal, the dimension "b" should not be measured in that radius area.
9. Coplanarity applies to the exposed heat slug as well as the terminal.
10. The 45° chamfer dimension C' is located by pin 1 on the bottom side of the package.



Disclaimer

ALL PRODUCT, PRODUCT SPECIFICATIONS AND DATA ARE SUBJECT TO CHANGE WITHOUT NOTICE TO IMPROVE RELIABILITY, FUNCTION OR DESIGN OR OTHERWISE.

Vishay Intertechnology, Inc., its affiliates, agents, and employees, and all persons acting on its or their behalf (collectively, "Vishay"), disclaim any and all liability for any errors, inaccuracies or incompleteness contained in any datasheet or in any other disclosure relating to any product.

Vishay makes no warranty, representation or guarantee regarding the suitability of the products for any particular purpose or the continuing production of any product. To the maximum extent permitted by applicable law, Vishay disclaims (i) any and all liability arising out of the application or use of any product, (ii) any and all liability, including without limitation special, consequential or incidental damages, and (iii) any and all implied warranties, including warranties of fitness for particular purpose, non-infringement and merchantability.

Statements regarding the suitability of products for certain types of applications are based on Vishay's knowledge of typical requirements that are often placed on Vishay products in generic applications. Such statements are not binding statements about the suitability of products for a particular application. It is the customer's responsibility to validate that a particular product with the properties described in the product specification is suitable for use in a particular application. Parameters provided in datasheets and / or specifications may vary in different applications and performance may vary over time. All operating parameters, including typical parameters, must be validated for each customer application by the customer's technical experts. Product specifications do not expand or otherwise modify Vishay's terms and conditions of purchase, including but not limited to the warranty expressed therein.

Hyperlinks included in this datasheet may direct users to third-party websites. These links are provided as a convenience and for informational purposes only. Inclusion of these hyperlinks does not constitute an endorsement or an approval by Vishay of any of the products, services or opinions of the corporation, organization or individual associated with the third-party website. Vishay disclaims any and all liability and bears no responsibility for the accuracy, legality or content of the third-party website or for that of subsequent links.

Except as expressly indicated in writing, Vishay products are not designed for use in medical, life-saving, or life-sustaining applications or for any other application in which the failure of the Vishay product could result in personal injury or death. Customers using or selling Vishay products not expressly indicated for use in such applications do so at their own risk. Please contact authorized Vishay personnel to obtain written terms and conditions regarding products designed for such applications.

No license, express or implied, by estoppel or otherwise, to any intellectual property rights is granted by this document or by any conduct of Vishay. Product names and markings noted herein may be trademarks of their respective owners.