

# PTC Thermistors, Inrush Current Limiter and Energy Load-Dump

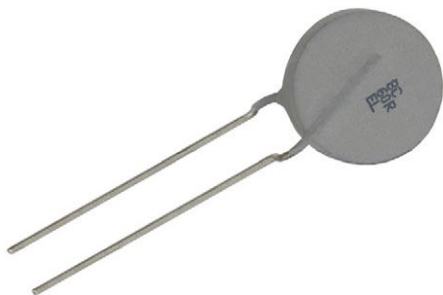

## ADDITIONAL RESOURCES



QUICK REFERENCE DATA		
PARAMETER	VALUE	UNIT
Resistance at 25 °C ( $R_{25}$ ) <sup>(1)</sup>	60 to 1000	$\Omega$
Switching temperature	130 to 140	°C
Maximum inrush current	40	A
Maximum AC voltage <sup>(1)</sup>	350 to 700	$V_{RMS}$
Maximum DC voltage <sup>(1)</sup>	500 to 1000	$V_{DC}$
Operating temperature range	-40 to 105	°C
Storage temperature range	-40 to 165	°C
Dissipation factor	14 to 19.5	mW/K
Thermal time constant (still air cooling)	105 to 120	s
Weight	3.5 to 5.7	g

### Note

- <sup>(1)</sup> Other resistance values and maximum operating voltages available on request.  
Matched resistance values available on request

## FEATURES

- High energy absorption levels up to 240 J
- High number of inrush-power cycles: > 100 000 cycles
- Highly resistant against non-switching peak-powers of up to 25 kW
- Can handle high direct voltage up to 1000 V
- Self protecting in case of overload with no risk of over-heating
- AEC-Q200 qualified
- Rugged construction
- Material categorization: for definitions of compliance please see [www.vishay.com/doc?99912](http://www.vishay.com/doc?99912)

**RoHS**  
COMPLIANT

## APPLICATIONS

Inrush current limiting and load-dump resistor in:

- Smoothing and DC-link capacitor banks
- Power inverters
- Discharge - charge circuits

PTCEL thermistors of similar resistance and size may be used in series and parallel combinations to obtain higher energy absorption levels. PTCEL thermistors may not be used in series connections to obtain higher voltage levels.

## DESCRIPTION

These directly heated ceramic-based doped barium titanate thermistors have a positive temperature coefficient and are primarily intended for inrush current limiting and overload protection. They consist of a ceramic pellet soldered between two tinned CCS wires and coated with a UL 94 V-0 compliant high temperature silicone lacquer. The body is marked with the logo, cold resistance value, EL on one side and date code on the opposite side.

## PACKAGING

PTC thermistors are available in 100 pieces (PTCEL13) or 50 pieces (PTCEL17) layered bulk packed or tape on reel option 500 pieces on request.

ELECTRICAL DATA AND ORDERING INFORMATION											
PART NUMBER	$R_{25}$ ( $\Omega$ )	$R_{25}$ TOL. (%)	$V_{MAX.}$ ( $V_{RMS}$ )	$V_{LINK MAX.}$ ( $V_{DC}$ )	$R_{MIN.}$ < 1.5 $V_{DC}$ ( $\Omega$ )	$I_{HOLD}$ AT 25°C (mA)	$C_{th}$ (J/K)	$E_{MAX.}$ 1 CYCLE AT 25°C (J)	$\tau_{th}$ (s)	DISSIPATION FACTOR (mW/K)	WEIGHT (g)
PTCEL13R600LBE	60	30	350	500	32	120	1.45	150	105	14.0	3.5
PTCEL13R121MBE	120	30	440	625	64	85	1.45	150	105	14.0	3.5
PTCEL13R251NBE	250	30	480	680	130	60	1.45	150	105	14.0	3.5
PTCEL13R501RBE	500	30	560	800	260	42	1.45	150	105	14.0	3.5
PTCEL13R102SBE	1000	30	600	850	520	30	1.45	150	105	14.0	3.5
PTCEL17R600MBE	60	30	440	625	32	140	2.3	240	120	19.5	5.7
PTCEL17R121NBE	120	30	460	650	64	100	2.3	240	120	19.5	5.7
PTCEL17R251SBE	250	30	600	850	130	70	2.3	240	120	19.5	5.7
PTCEL17R501TBE	500	30	700	1000	260	50	2.3	230	120	19.5	5.7

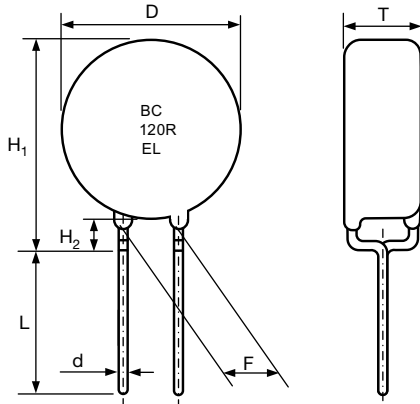
**OUTLINE AND DIMENSIONS**

**COMPONENT DIMENSIONS** in millimeters

	PTCEL13	PTCEL17
D	13.5 max.	17 max.
H1	17 max.	21 max.
H2	3 ± 1	3 ± 1
d	0.6 ± 0.06	0.8 ± 0.08
L	20 min.	20 min.
F (1)	5 ± 0.8	5 ± 0.8
T	7.0 max.	7.5 max.

**Note**

(1) F pitch = 7.5 mm available on request

**REQUIRED NUMBER OF PTC THERMISTORS TO LIMIT CURRENT AND ABSORB ENERGY**

By using several PTC's in a series / parallel network, the maximum current limitation and absorbed energy levels can be further optimized. For homogeneous current and energy distribution it is recommended to combine only PTCEL of the same size and matched resistance value. Energy absorption per PTC in a network depends on current distribution in the network and as such on the individual PTC resistance value. PTCEL thermistors might be used in a series connection to further lower the inrush current, but not to increase the maximum allowed voltage levels. Following formula may be used to calculate the minimum number of PTCEL thermistors of the same size and matched resistance value that are required in a DC link or other capacitor bank application to properly charge or discharge a given amount of energy without follow current:

$$N \geq \frac{K \times C \times V^2}{2 \times C_{th} \times (T_{sw} - T_{amb})}$$

**Notes**

- N is the number of PTCEL required in the network
- C is the total capacitor value to charge or discharge in F
- V is the maximum DC voltage on the capacitor C
- $C_{th}$  is the thermal capacity of one PTC in [J/K] (see table)
- $T_{sw}$  is the minimum switching temperature of the PTCEL (130 °C)
- $T_{amb}$  is the maximum ambient temperature at which the PTC needs to operate
- K is the factor that determines the charging operation mode  
 K = 1 for DC charging or discharging  
 K = 0.96 for 3-phase rectified charging  
 K = 0.76 for single phase rectified charging

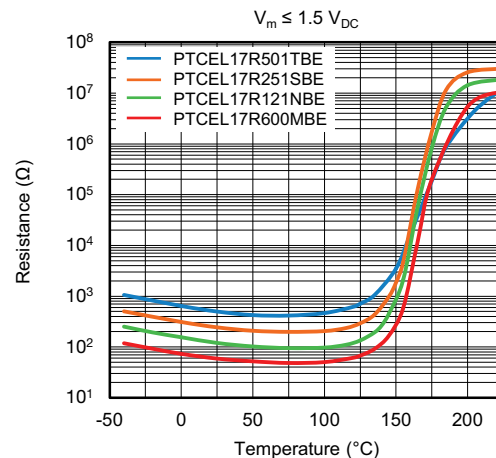
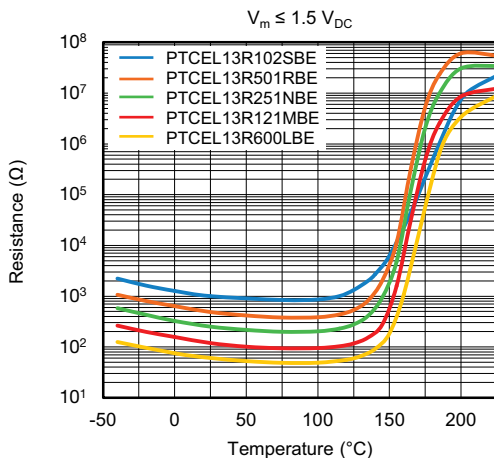
**RESISTANCE VS. TEMPERATURE**



MINIMUM PTC RESISTANCE UNDER PULSED VOLTAGE

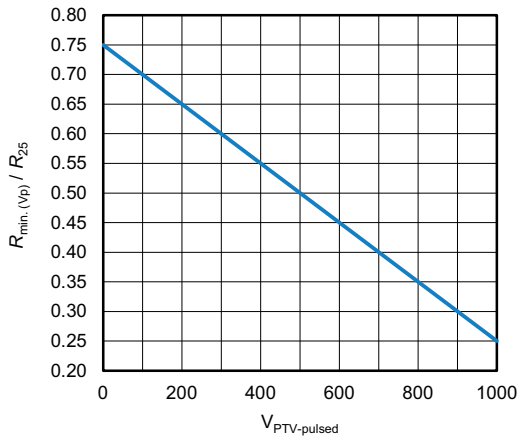

$V_{MAX.}$  DERATING VS.  $T_{AMB}$

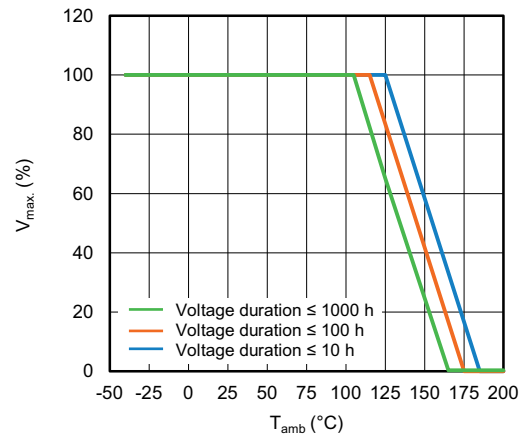

RESIDUAL CURRENT VS. VOLTAGE

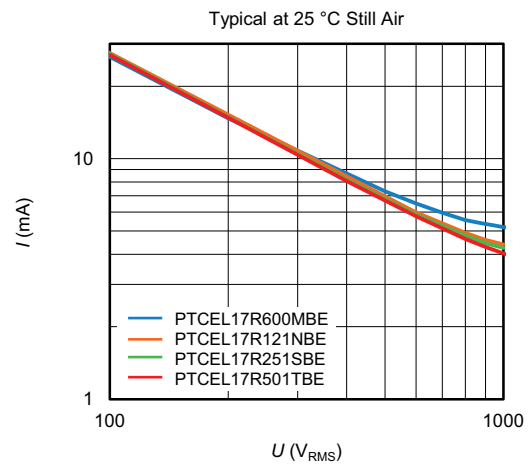
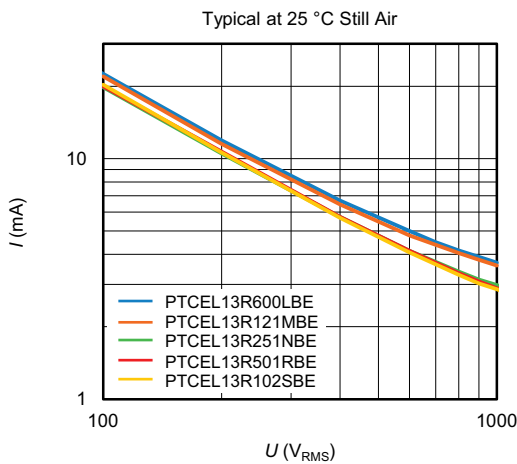

CONSECUTIVE ENERGY LOAD-DUMPS AT DIFFERENT  $T_{AMB}$  FOR PTCEL13

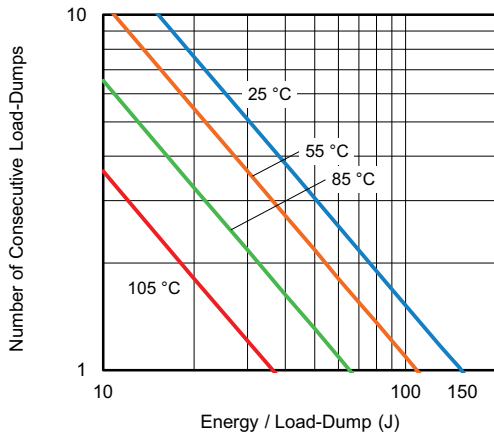

CONSECUTIVE ENERGY / LOAD-DUMPS AT DIFFERENT  $T_{AMB}$  FOR PTCEL17

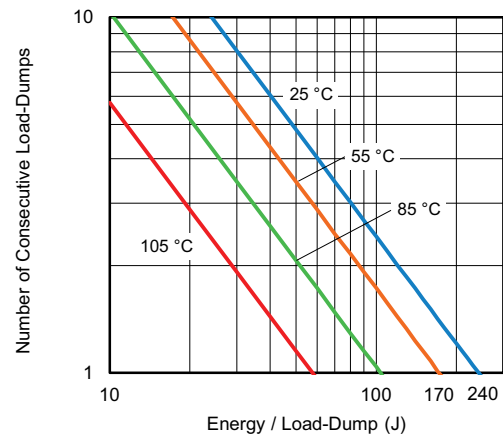



## Disclaimer

ALL PRODUCT, PRODUCT SPECIFICATIONS AND DATA ARE SUBJECT TO CHANGE WITHOUT NOTICE TO IMPROVE RELIABILITY, FUNCTION OR DESIGN OR OTHERWISE.

Vishay Intertechnology, Inc., its affiliates, agents, and employees, and all persons acting on its or their behalf (collectively, "Vishay"), disclaim any and all liability for any errors, inaccuracies or incompleteness contained in any datasheet or in any other disclosure relating to any product.

Vishay makes no warranty, representation or guarantee regarding the suitability of the products for any particular purpose or the continuing production of any product. To the maximum extent permitted by applicable law, Vishay disclaims (i) any and all liability arising out of the application or use of any product, (ii) any and all liability, including without limitation special, consequential or incidental damages, and (iii) any and all implied warranties, including warranties of fitness for particular purpose, non-infringement and merchantability.

Statements regarding the suitability of products for certain types of applications are based on Vishay's knowledge of typical requirements that are often placed on Vishay products in generic applications. Such statements are not binding statements about the suitability of products for a particular application. It is the customer's responsibility to validate that a particular product with the properties described in the product specification is suitable for use in a particular application. Parameters provided in datasheets and / or specifications may vary in different applications and performance may vary over time. All operating parameters, including typical parameters, must be validated for each customer application by the customer's technical experts. Product specifications do not expand or otherwise modify Vishay's terms and conditions of purchase, including but not limited to the warranty expressed therein.

Hyperlinks included in this datasheet may direct users to third-party websites. These links are provided as a convenience and for informational purposes only. Inclusion of these hyperlinks does not constitute an endorsement or an approval by Vishay of any of the products, services or opinions of the corporation, organization or individual associated with the third-party website. Vishay disclaims any and all liability and bears no responsibility for the accuracy, legality or content of the third-party website or for that of subsequent links.

Except as expressly indicated in writing, Vishay products are not designed for use in medical, life-saving, or life-sustaining applications or for any other application in which the failure of the Vishay product could result in personal injury or death. Customers using or selling Vishay products not expressly indicated for use in such applications do so at their own risk. Please contact authorized Vishay personnel to obtain written terms and conditions regarding products designed for such applications.

No license, express or implied, by estoppel or otherwise, to any intellectual property rights is granted by this document or by any conduct of Vishay. Product names and markings noted herein may be trademarks of their respective owners.