

Description

The DIODES DPS1135 is part of a family of power switches optimized for USB power delivery and other hot-swap applications. Through the analog interface, an exception status is reported, and several functions can be programmed: current limit, overvoltage protection, and output voltage ramping up. The fast role-swap function, which complies with the requirements defined in the USB Power Delivery Specification Release 3.0, V1.0a, is implemented. It is compatible to many popular USB Type-C® applications.

This device is designed to operate between 4V and 24V. It offers fast short-circuit response time to ensure system robustness. The integrated port-discharge function allows the voltage levels at the input and output ports to be discharged to meet the requirements of the USB Power Delivery Specification. Comprehensive fault detection and recovery mechanisms are provisioned to enable applications, which are subjected to heavy capacitive loads and the risk of short circuit. These mechanisms include: reverse voltage and current blocking, input overvoltage protection, output overcurrent, short-circuit protection, and over temperature shut-down. In addition, the rise time of output voltage can be adjusted to minimize in-rush current and to ensure system stability. Before any exception condition is notified via the low-active FAULTB signal, a deglitch of 7ms is applied to prevent false triggering.

The DPS1135 is housed in the low-profile and space-saving V-QFN4040-17 package, which is manufactured with environmentally friendly material.

Features

- Wide Operating Voltage Range: 4V to 24V
- One-Channel Power Switch with Integrated Adjustable Current & Voltage Limits
- Ability to Discharge the Input and Output Ports either Individually or Simultaneously via Two External Control Pins
- Fast Short-Circuit Response Time at 2μs
- Comprehensive Built-In Fault Detection and Recovery Mechanisms like Input Under Voltage Lock-Out, Reverse Voltage and Current Blocking, Thermal Shutdown, Overcurrent and Short-Circuit Protection
- $R_{DS(ON)}$ of Embedded MOSFET at 30mΩ
- Adjustable DV/DT Control at Start-Up
- Fault Reporting (FAULTB) with Blanking Time at 7ms Typical
- Fast Role Swap Supported
- **Totally Lead-Free & Fully RoHS Compliant (Notes 1 & 2)**
- **Halogen and Antimony Free. "Green" Device (Note 3)**
- **For automotive applications requiring specific change control (i.e. parts qualified to AEC-Q100/101/104/200, PPAP capable, and manufactured in IATF 16949 certified facilities), please [contact us](https://www.diodes.com/quality/product-definitions/) or your local Diodes representative.**

Notes: 1. No purposely added lead. Fully EU Directive 2002/95/EC (RoHS), 2011/65/EU (RoHS 2) & 2015/863/EU (RoHS 3) compliant.
 2. See <https://www.diodes.com/quality/lead-free/> for more information about Diodes Incorporated's definitions of Halogen- and Antimony-free, "Green" and Lead-free.
 3. Halogen- and Antimony-free "Green" products are defined as those which contain <900ppm bromine, <900ppm chlorine (<1500ppm total Br + Cl) and <1000ppm antimony compounds.

Pin Assignments

(Top View)

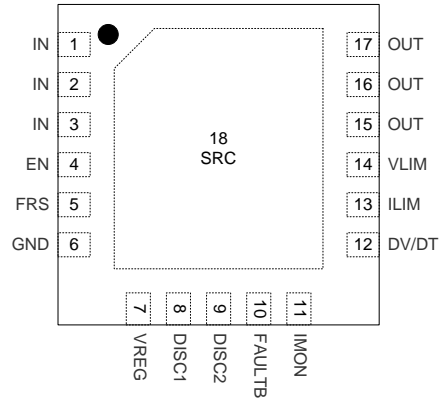

V-QFN4040-17

Applications

- Notebooks, desktops, AIO PCs, servers, and tablets
- Docking stations, universals and multimedia hubs
- FPTVs, PC monitors
- Set-Top boxes, residential gateways, storage devices
- Power protections in industrials and automotive applications

Typical Application Circuit

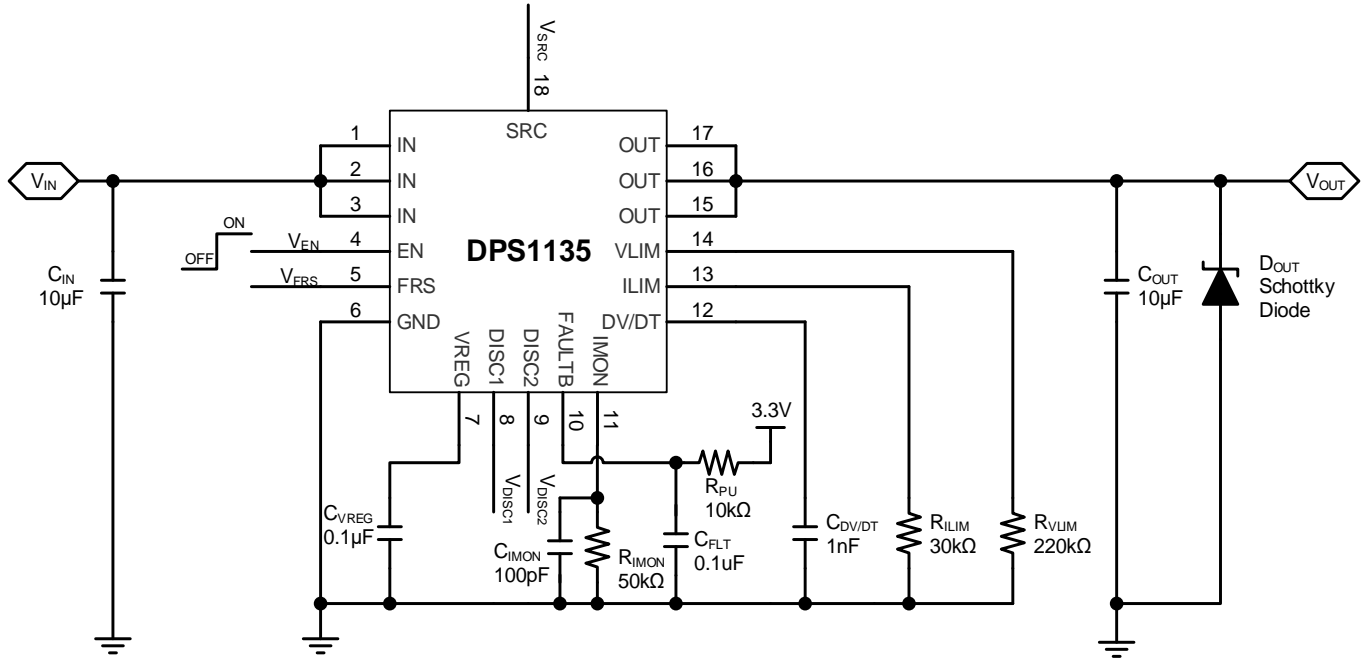

Figure 1. Typical Application Circuit for The DPS1135 Power Switch

Pin Descriptions

Pin Number	Pin Name	Type	Function
1, 2, 3	IN	P	Power Supply and Input Port.
4	EN	I	Enable Input; Active High. 0 = Device Off 1 = Device On This pin must not be left floating.
5	FRS	I	Fast Role Swap Control. This pin enables the Fast Role Swap sequence defined in the USB Power Delivery Specification Release 3.0, V1.0a.
6	GND	GND	Device Ground.
7	VREG	I/O	Voltage Regulator. A 0.1µF is recommended between this pin and GND.
8	DISC1	I	IN Port Discharge Control. 1 = Port Voltage to be Discharged 0 = Disabled
9	DISC2	I	OUT Port Discharge Control. 1 = Port Voltage to be Discharged 0 = Disabled
10	FAULTB	O	Fault Status Indicator. An external pull-up resistor is required. A 0.1µF capacitor is recommended between this pin and GND. This active-low pin is tied to GND when not used.
11	IMON	O	Current Monitor. A 100pF capacitor and a resistor connected in parallel between this pin and GND creates a positive average voltage proportional to the current flowing through the device. This pin can be left floating if current monitoring is not required.
12	DV/DT	I/O	Ramp-up Control. A capacitor between this pin and GND sets the ramp-up rate.
13	ILIM	I/O	Current Limit Setting. A resistor between this pin and GND sets the overcurrent limit of the OUT port.
14	VLIM	I/O	Voltage Limit Setting. A resistor between this pin and GND sets the overvoltage limit of the IN port.
15, 16, 17	OUT	O	Output Port.
18 (Exposed Pad)	SRC	I/O	Common Source. The exposed pad of the V-QFN4040-17 package must not be connected to any signal.

Functional Block Diagram

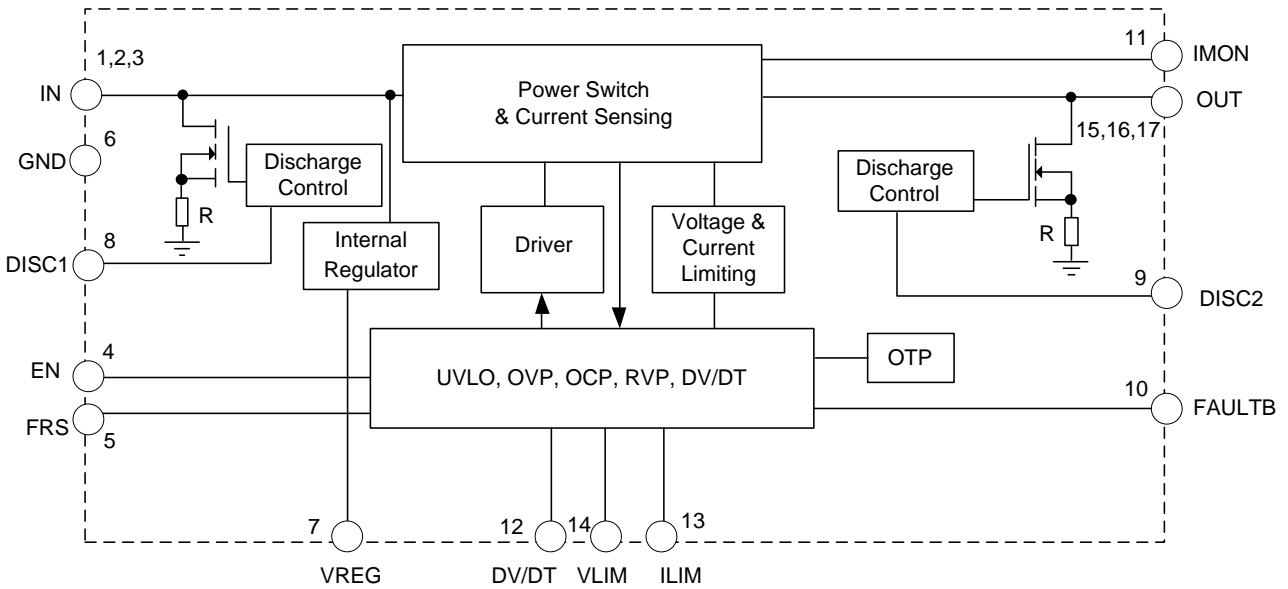

Figure 2. Internal Functional Blocks of The DPS1135

Absolute Maximum Ratings (@ $T_A = +25^\circ\text{C}$, unless otherwise specified.) (Note 4)

Symbol	Parameter	Rating	Unit
V_{IN}, V_{OUT}	Voltage Range of Power IN and OUT Pins	-0.3 to 30	V
V_{EN}	Voltage Range of EN Pin	-0.3 to 30	V
$V_{I/O}$	Voltage Range of Other Pins (FRS, VREG, DISC1, DISC2, FAULTB, IMON, DV/DT, ILIM, VLIM)	-0.3 to 6	V
I_{OUT}	Load Current Range	6.5	A
$I_{OUTPULSE}$	Load Current Range ($R_{ILIM} = 6.8\text{k}\Omega$, 1s Pulse, Duty Cycle = 1%)	14	A
T_J	Operating Junction Temperature	-40 to +125	$^\circ\text{C}$
T_L	Lead Temperature	+260	$^\circ\text{C}$
T_{ST}	Storage Temperature	-65 to +150	$^\circ\text{C}$
ESD	Human Body Model (HBM), JESD22-A114	2	kV
	Charge Device Model (CDM)	1	

Note: 4. These are stress ratings only. Operation outside the absolute maximum ratings can cause device failure. Operation at the absolute maximum rating for extended periods may reduce device reliability.

Thermal Characteristics (@ $T_A = +25^\circ\text{C}$, unless otherwise specified.) (Note 5)

Symbol	Parameter	Rating	Unit
P_D	Power Dissipation	1.7	W
$R_{\theta JA}$	Thermal Resistance, Junction-to-Ambient	58.5	$^\circ\text{C}/\text{W}$
$R_{\theta JC}$	Thermal Resistance, Junction-to-Case	12.3	$^\circ\text{C}/\text{W}$

Note: 5. Device mounted on FR-4 substrate PCB, 2oz copper, with 1" x 1" copper pad layout.

Recommended Operating Conditions (@ $T_A = +25^\circ\text{C}$, unless otherwise specified.)

Symbol	Parameter	Min	Max	Unit
V_{IN}	Input Supply Voltage	4	24	V
V_{OUT}	Output Voltage	0	24	V
I_{OUT}	Output Load Current	0	5	A
C_{IN}	Input Capacitance	10	—	μF
C_{OUT}	Output Capacitance	1	100	μF
V_{EN}	Input Voltage on EN Pin	0	28	V
$V_{FRS}, V_{DISC1}, V_{DISC2}$	Input Voltage on FRS, DISC1, DISC2 Pins	0	5.5	V
R_{VLIM}	VLIM Resistance	51	270	$\text{k}\Omega$
R_{ILIM}	ILIM Resistance	15	200	$\text{k}\Omega$

Electrical Characteristics (@ $T_A = +25^\circ\text{C}$, $V_{IN} = 4\text{V}$ to 24V , $C_{IN} = C_{OUT} = 10\mu\text{F}$, $V_{EN} = 3.3\text{V}$, $V_{FRS} = 0\text{V}$, $C_{DV}/DT = 1\text{nF}$, $R_{VLIM} = 240\text{k}\Omega$, $R_{ILIM} = 27\text{k}\Omega$, unless otherwise specified.)

Symbol	Parameter	Conditions	Min	Typ.	Max	Unit
Bias Supply						
V_{REG}	Regulated Voltage	$V_{IN} = 5\text{V}$	—	4.9	—	V
		$V_{IN} = 12\text{V}$	—	5.1	—	
		$V_{IN} = 24\text{V}$	—	5.2	—	
V_{UVLO}	V_{IN} Under Voltage Lock-Out Threshold	V_{IN} Rising	3.2	3.6	4.0	V
V_{UVHY}	V_{IN} Under Voltage Lock-Out Threshold Hysteresis	V_{IN} Falling	—	250	—	mV
I_{SHDN}	Shut-Down Current (Disabled)	$V_{IN} = 5\text{V}, V_{EN} = 0\text{V}$	—	—	5	μA
		$V_{IN} = 12\text{V}, V_{EN} = 0\text{V}$	—	—	15	
		$V_{IN} = 24\text{V}, V_{EN} = 0\text{V}$	—	—	25	
I_Q	Quiescent Current (Enabled)	$V_{IN} = 5\text{V}, \text{No Load}$	—	1.5	1.9	mA
		$V_{IN} = 12\text{V}, \text{No Load}$	—	1.7	2.1	
		$V_{IN} = 24\text{V}, \text{No Load}$	—	2.2	2.6	
MOSFET						
$R_{DS(ON)}$	Switch ON Resistance	$V_{IN} = 5\text{V}$	—	29	36	m Ω
		$V_{IN} = 12\text{V}$	—	29	36	
		$V_{IN} = 24\text{V}$	—	30	36	
I_{LKGSRC}	OUT Leakage Current in OFF State, Sourcing	$V_{EN} = 0\text{V}, V_{OUT} = 0\text{V}$	—	—	1	μA
I_{LKGSNK}	OUT Leakage Current in OFF State, Sinking	$V_{IN} = 3.3\text{V}, V_{EN} = 0\text{V}, V_{OUT} = 5\text{V}$	—	—	15	μA
		$V_{IN} = 3.3\text{V}, V_{EN} = 0\text{V}, V_{OUT} = 12\text{V}$	—	—	25	
		$V_{IN} = 3.3\text{V}, V_{EN} = 0\text{V}, V_{OUT} = 24\text{V}$	—	—	40	
Enable Control						
V_{ENL}	EN Threshold Voltage Low	V_{EN} Falling	—	—	0.4	V
V_{ENH}	EN Threshold Voltage High	V_{EN} Rising	1.4	—	—	
I_{EN}	EN Input Leakage Current	$V_{IN} = 5\text{V}, V_{EN} = 5\text{V}$	—	—	5	μA
Output Ramping Control						
I_{DV}/DT	DV/DT Sourcing Current	$V_{DV}/DT = 0\text{V}$	—	1	—	μA
G_{DV}/DT	DV/DT to OUT Gain	$\Delta V_{OUT} / \Delta V_{DV}/DT$, Guaranteed by Design	—	12	—	V/V

Electrical Characteristics (continued) (@ $T_A = +25^\circ\text{C}$, $V_{IN} = 4\text{V to } 24\text{V}$, $C_{IN} = C_{OUT} = 10\mu\text{F}$, $V_{EN} = 3.3\text{V}$, $V_{FRS} = 0\text{V}$, $C_{DV}/DT = 1\text{nF}$, $R_{VLIM} = 240\text{k}\Omega$, $R_{ILIM} = 27\text{k}\Omega$, unless otherwise specified.)

Symbol	Parameter	Conditions	Min	Typ	Max	Unit
Output Timing						
td_ON	Output Turn-On Delay Time	$V_{IN} = 5\text{V}$, $C_{OUT} = 1\mu\text{F}$, $V_{EN} = 0\text{V to } 3.3\text{V}$	—	0.2	—	ms
		$V_{IN} = 12\text{V}$, $C_{OUT} = 1\mu\text{F}$, $V_{EN} = 0\text{V to } 3.3\text{V}$	—	0.2	—	
		$V_{IN} = 24\text{V}$, $C_{OUT} = 1\mu\text{F}$, $V_{EN} = 0\text{V to } 3.3\text{V}$	—	0.2	—	
tr	Output Turn-On Rise Time	$V_{IN} = 5\text{V}$, $C_{OUT} = 1\mu\text{F}$, $V_{EN} = 0\text{V to } 3.3\text{V}$	—	0.3	—	ms
		$V_{IN} = 12\text{V}$, $C_{OUT} = 1\mu\text{F}$, $V_{EN} = 0\text{V to } 3.3\text{V}$	—	0.8	—	
		$V_{IN} = 24\text{V}$, $C_{OUT} = 1\mu\text{F}$, $V_{EN} = 0\text{V to } 3.3\text{V}$	—	1.6	—	
td_OFF	Output Turn-Off Delay Time	$V_{IN} = 5\text{V}$, $C_{OUT} = 1\mu\text{F}$, $V_{EN} = 3.3\text{V to } 0\text{V}$	—	1	—	μs
		$V_{IN} = 12\text{V}$, $C_{OUT} = 1\mu\text{F}$, $V_{EN} = 3.3\text{V to } 0\text{V}$	—	2	—	
		$V_{IN} = 24\text{V}$, $C_{OUT} = 1\mu\text{F}$, $V_{EN} = 3.3\text{V to } 0\text{V}$	—	4	—	
tf	Output Turn-Off Fall Time	$V_{IN} = 5\text{V}$, $C_{OUT} = 1\mu\text{F}$, $V_{EN} = 3.3\text{V to } 0\text{V}$	—	10	—	μs
		$V_{IN} = 12\text{V}$, $C_{OUT} = 1\mu\text{F}$, $V_{EN} = 3.3\text{V to } 0\text{V}$	—	25	—	
		$V_{IN} = 24\text{V}$, $C_{OUT} = 1\mu\text{F}$, $V_{EN} = 3.3\text{V to } 0\text{V}$	—	50	—	
Fast Role Swap (FRS) Control and Timing						
VFRSL	FRS Threshold Voltage Low	VFRS Falling	—	—	0.4	V
VFRSH	FRS Threshold Voltage High	VFRS Rising	1.4	—	—	
IFRS	FRS Input Leakage Current	$V_{IN} = 5\text{V}$, $V_{FRS} = 5\text{V}$	—	—	7	μA
tFRS_ON	FRS On Time	$V_{IN} = 5\text{V}$, A Single Positive Pulse Width on FRS and $V_{FRSH} = 3.3\text{V}$, Guaranteed by Design	600	—	—	μs
tDON_FRS	Output Turn-On Delay Time with FRS	$V_{IN} = 5\text{V}$, $C_{OUT} = 1\mu\text{F}$, $V_{FRS} = 3.3\text{V to } 0\text{V}$, 50% Falling Edge of VFRS to 90% Rising Edge of VOUT, Guaranteed by Design	—	—	60	μs
Discharge Control on IN and OUT Ports						
RDISC1 / RDISC2	IN / OUT Discharge Resistance	$V_{DISC1} = 5\text{V}$, $V_{DISC2} = 5\text{V}$	—	105	—	Ω
		$V_{DISC1} = 3.3\text{V}$, $V_{DISC2} = 3.3\text{V}$	—	115	—	Ω
VDISC1L / VDISC2L	DISC1 / DISC2 Threshold Voltage Low	V_{DISC1} / V_{DISC2} Falling	—	—	0.4	V
VDISC1H / VDISC2H	DISC1 / DISC2 Threshold Voltage High	V_{DISC1} / V_{DISC2} Rising	1.4	—	—	V
Overcurrent Protection						
VILIM	ILIM Bias Voltage	$R_{ILIM} = 50\text{k}\Omega$	—	1	—	V
ILIM	Current Limit, 2A	$R_{ILIM} = 50\text{k}\Omega$	1.7	2	2.3	A
	Current Limit, 3A	$R_{ILIM} = 33.3\text{k}\Omega$	2.7	3	3.3	
	Current Limit, 4.5A	$R_{ILIM} = 22.1\text{k}\Omega$	4.05	4.5	4.95	
IFASTRIP	Fast-Trip Threshold	Guaranteed by Design	—	$1.125 \times I_{LIM} + 1.8$	—	A
Current Monitoring Output						
VIMON	Current Monitoring Output Voltage	—	—	—	$V_{IN} - 0.5\text{V}$	V
GIMON	IMON to OUT Current Gain	I_{MON} / I_{OUT}	—	10	—	$\mu\text{A/A}$
Overvoltage Protection						
VLIM	VLIM Sourcing Current	$V_{IN} = 5\text{V}$, $R_{VLIM} = 54.9\text{k}\Omega$	—	10	—	μA
VOVPRTH	Input Overvoltage Threshold, Rising	$R_{VLIM} = 54.9\text{k}\Omega$, V_{IN} Rising	—	6	—	V
		$R_{VLIM} = 240\text{k}\Omega$, V_{IN} Rising	—	24.5	—	
VOVPFTH	Input Overvoltage Threshold, Falling	$R_{VLIM} = 54.9\text{k}\Omega$, V_{IN} Falling	—	5.5	—	V
		$R_{VLIM} = 240\text{k}\Omega$, V_{IN} Falling	—	24	—	

Electrical Characteristics (continued) (@ $T_A = +25^\circ\text{C}$, $V_{IN} = 4\text{V}$ to 24V , $C_{IN} = C_{OUT} = 10\mu\text{F}$, $V_{EN} = 3.3\text{V}$, $V_{FRS} = 0\text{V}$, $C_{DV/DT} = 1\text{nF}$, $R_{VLIM} = 240\text{k}\Omega$, $R_{ILIM} = 27\text{k}\Omega$, unless otherwise specified.)

Symbol	Parameter	Conditions	Min	Typ	Max	Unit
Reverse-Voltage Protection						
V_{RVPFTH}	$V_{IN} - V_{OUT}$ Threshold Entering into Reverse Protection	$V_{IN} - V_{OUT}$ Falling	—	-30	—	mV
V_{RVPRTH}	$V_{IN} - V_{OUT}$ Threshold Exiting from Reverse Protection	$V_{IN} - V_{OUT}$ Rising	—	0	—	
t_{RVPTD}	Reverse Protection Response Time	—	—	2	—	μs
Fault Flag (FAULTB): Active-Low						
R_{FAULTB}	FAULTB Pull-Down Resistor	$V_{IN} = 7\text{V}$, $R_{VLIM} = 54.9\text{k}\Omega$, $I_{FAULTB} = 10\text{mA}$ Sinking	—	25	—	Ω
$I_{LKGFAULTB}$	FAULTB Leakage Current	$V_{IN} = 5\text{V}$, $R_{VLIM} = 54.9\text{k}\Omega$, $V_{FAULTB} = 5\text{V}$	—	—	1	μA
$t_{BLANKFAULTB}$	FAULTB Blanking Time	$V_{IN} = 5\text{V}$, $R_{VLIM} = 54.9\text{k}\Omega$, $V_{FAULTB} = 5\text{V}$	—	7	—	ms
Thermal Shutdown						
T_{SHDN}	Thermal Shutdown Threshold	—	—	+165	—	$^\circ\text{C}$
T_{HYS}	Thermal Shutdown Hysteresis	—	—	+20	—	

Performance Characteristics (@ $T_A = +25^\circ\text{C}$, $C_{IN} = C_{OUT} = 10\mu\text{F}$, $V_{EN} = 3.3\text{V}$, $V_{FRS} = 0\text{V}$, $C_{DV}/DT = 1\text{nF}$, $R_{LIM} = 27\text{k}\Omega$, unless otherwise specified.)

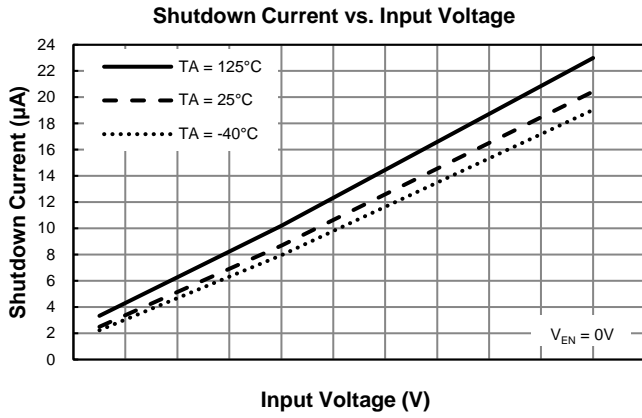

Figure 3. Shutdown Current vs Input Voltage

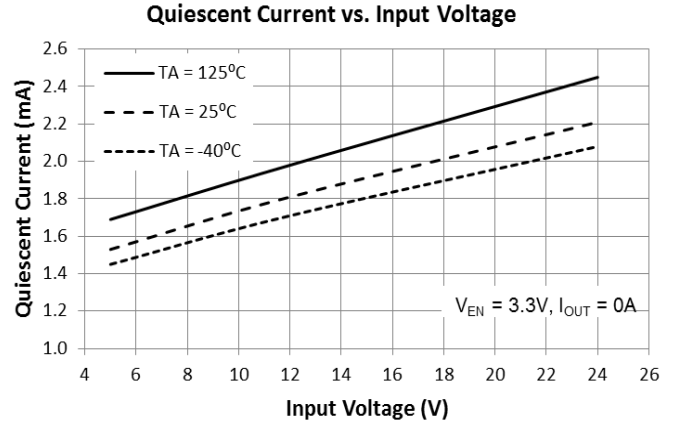

Figure 4. Quiescent Current vs. Input Voltage

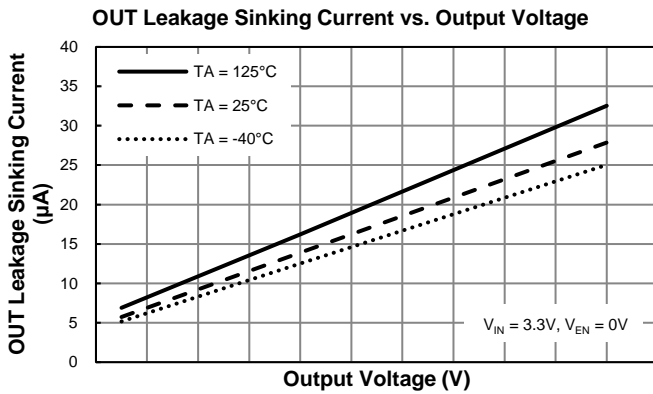

Figure 5. OUT Leakage Current vs. Output Voltage

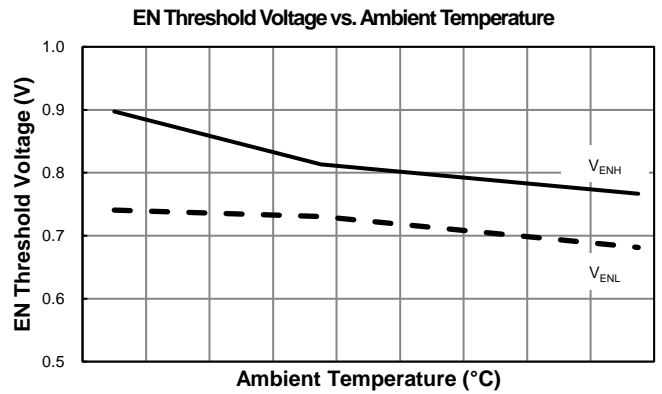

Figure 6. EN Threshold Voltage vs. Ambient Temperature

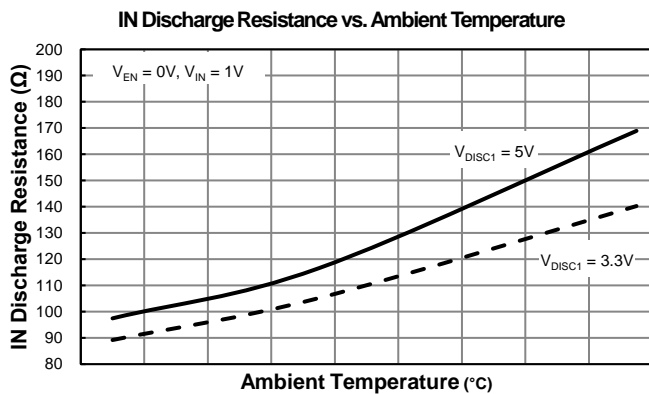

Figure 7. IN Discharge Resistance vs. Ambient Temperature

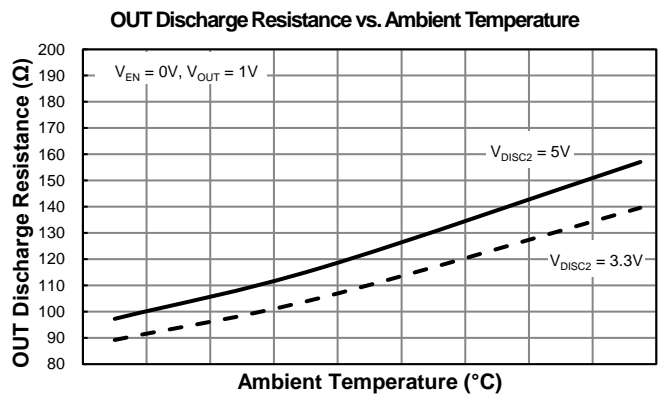

Figure 8. OUT Discharge Resistance vs. Ambient Temperature

Performance Characteristics (continued) (@ $T_A = +25^\circ\text{C}$, $C_{IN} = C_{OUT} = 10\mu\text{F}$, $V_{EN} = 3.3\text{V}$, $V_{FRS} = 0\text{V}$, $C_{D}/DT = 1\text{nF}$, $R_{LIM} = 27\text{k}\Omega$, unless otherwise specified.)

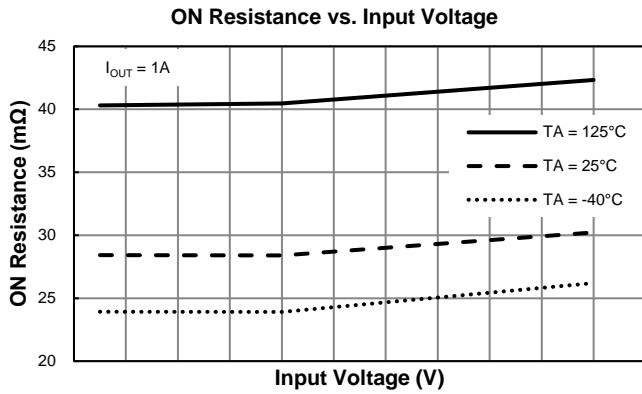

Figure 9. ON Resistance vs. Input Voltage

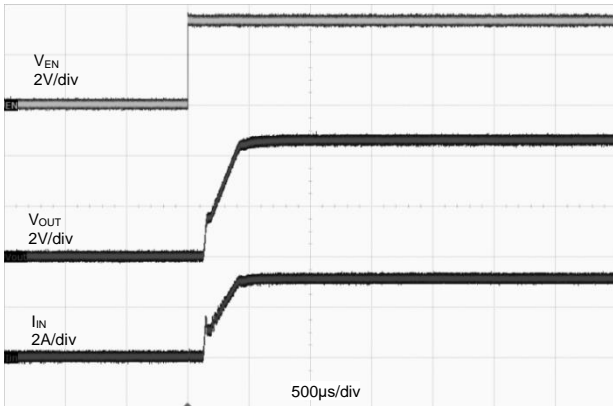

Figure 10. EN Turn ON
 $V_{IN} = 5\text{V}$, Load = 1.6Ω

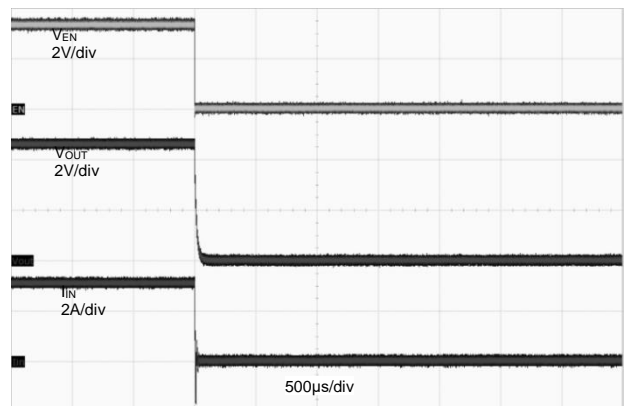

Figure 11. EN Turn OFF
 $V_{IN} = 5\text{V}$, Load = 1.6Ω

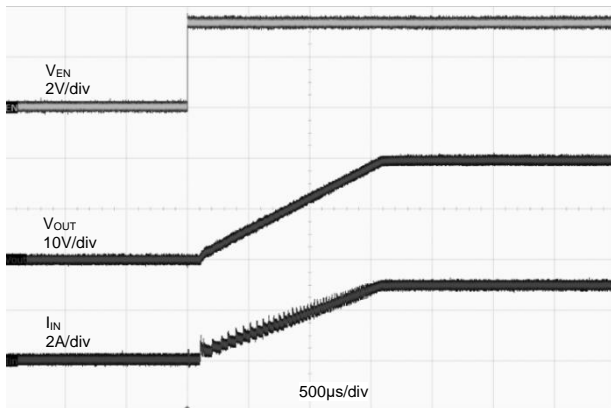

Figure 12. EN Turn ON
 $V_{IN} = 20\text{V}$, Load = 6.7Ω

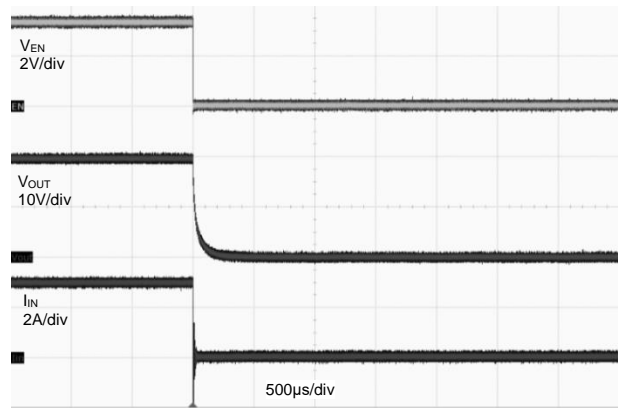

Figure 13. EN Turn OFF
 $V_{IN} = 20\text{V}$, Load = 6.7Ω

Performance Characteristics (continued) (@ $T_A = +25^\circ\text{C}$, $C_{IN} = C_{OUT} = 10\mu\text{F}$, $V_{EN} = 3.3\text{V}$, $V_{FRS} = 0\text{V}$, $C_{D/DT} = 1\text{nF}$, $R_{LIM} = 27\text{k}\Omega$, unless otherwise specified.)

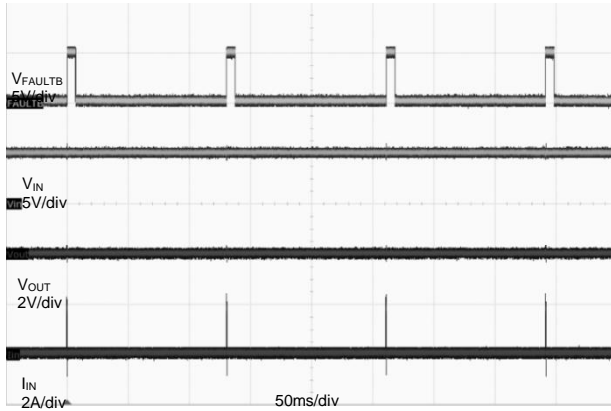

Figure 14. OUT Short to Ground, $V_{IN} = 5\text{V}$

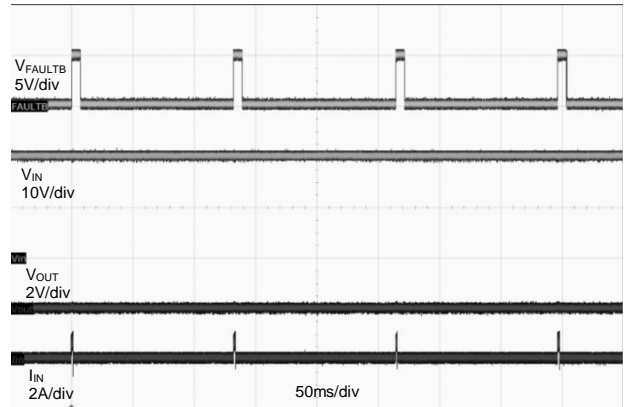

Figure 15. OUT Short to Ground, $V_{IN} = 20\text{V}$

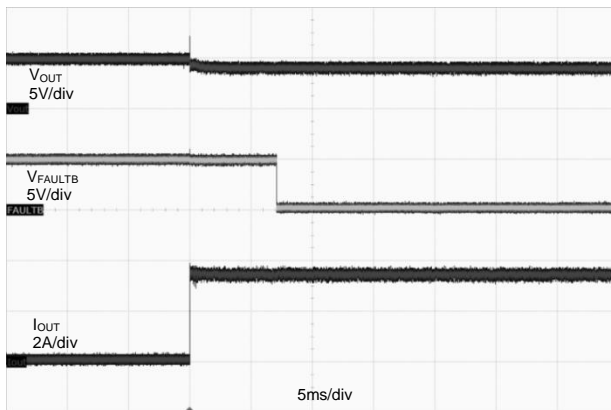

Figure 16. Overcurrent Protection
 $V_{IN} = 5\text{V}$, Load = 100Ω to 1.2Ω

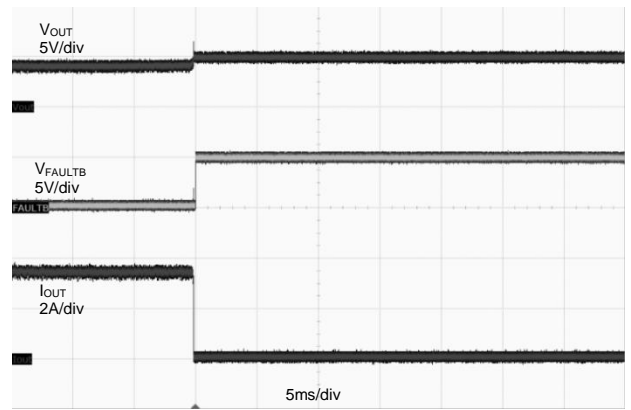

Figure 17. Overcurrent Recovery
 $V_{IN} = 5\text{V}$, Load = 1.2Ω to 100Ω



Figure 18. Input Overvoltage Protection and Recovery
 $V_{IN} = 5 - 7 - 5\text{V}$, $R_{VLIM} = 56\text{k}\Omega$, Load = $1\text{k}\Omega$

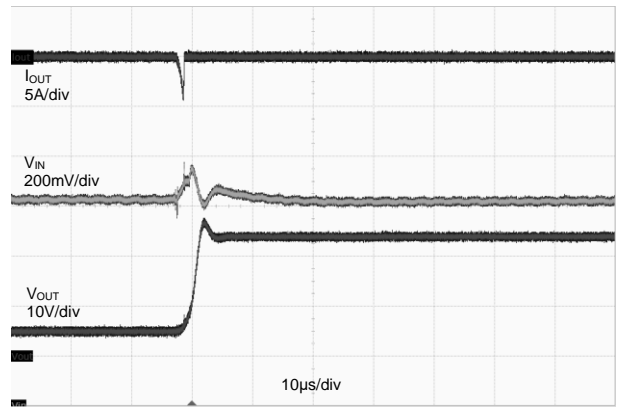

Figure 19. Reverse Voltage Response
 $V_{IN} = 5\text{V}$, OUT short to 24V

Application Information

General Description

The DPS1135 is a one-channel power switch designed to meet the input and output voltage/current requirement, which are common with many hot-pluggable serial interfaces found in the computing and consumer electronics equipment. For example, the DPS1135 is compatible to the USB Power Delivery Specification Release 3.0, V1.0a and many popular USB Type-C® applications.

Start-Up Time

An external capacitor connected from the DV/DT pin to GND defines the slew rate of the output voltage at power-on:

$$dV_{OUT} / dt = (I_{DV/DT} / C_{DV/DT}) \times G_{DV/DT}$$

Where:

- dV_{OUT} / dt is the desired output slew rate in V/ms
- $I_{DV/DT}$ is in μA and is $1\mu A$ typical
- $C_{DV/DT}$ is the ramp-up control setting capacitor in nF
- $G_{DV/DT}$ is the gain of DV/DT to OUT and $G_{DV/DT} = 12$

The total ramp time $t_{DV/DT}$ of V_{OUT} increasing from 0 to V_{IN} can be calculated using:

$$t_{DV/DT} = 8.3 \times 10^{-2} \times V_{IN} \times C_{DV/DT}$$

Where:

- $t_{DV/DT}$ is the total ramp time in ms
- V_{IN} is in V
- $C_{DV/DT}$ is in nF

Choosing a proper value for the capacitor $C_{DV/DT}$ ensures that the device is turned ON with the preset ramp-up imposed over the output voltage. The in-rush current at power-up is limited by the regulated output voltage ramp or the limited current setting.

C _{OUT} (μF)	R _{LIM} (kΩ)	I _{LIM_MIN} (A)	I _{LOAD_MAX} (A)	C _{DV/DT_MIN} (nF)	Start-Up Time (ms)		
					V _{IN} = 5V	V _{IN} = 12V	V _{IN} = 20V
10	18	5.10	5	0.51	0.21	0.51	0.85
10	30	3.10	3	0.51	0.21	0.51	0.85
10	43	2.09	2	0.51	0.21	0.51	0.85
100	18	5.10	5	3.6	1.50	3.60	6.00
100	30	3.10	3	3.6	1.50	3.60	6.00
100	43	2.09	2	3.6	1.50	3.60	6.00

Input Over Voltage Protection (OVP)

The voltage at the IN port is monitored continuously. Whenever voltage at the IN port is found to be larger than the V_{OVPRTH} value, the built-in Over Voltage Protection (OVP) fault-handling mechanism is triggered. The internal power MOSFET turns off to protect the downstream equipment connected. The V_{OVPRTH} value is determined by:

$$V_{OVPRTH} = 0.1 \times R_{VLIM} + 0.5$$

Where:

- V_{OVPRTH} is in V
- R_{VLIM} is in kΩ
- $51k\Omega \leq R_{VLIM} \leq 270k\Omega$

Application Information (continued)

Reverse-Voltage Protection (RVP)

The voltage difference, $[V_{IN} - V_{OUT}]$, between the IN and OUT ports is monitored continuously. Once the voltage difference drops below the V_{RVPTH} level, the device immediately turns OFF the internal power MOSFET to prevent the current flowing from the opposite direction. When the reverse-voltage condition is no longer valid, i.e. $[V_{IN} - V_{OUT}]$ becomes greater than the V_{RVPTH} level, the internal power MOSFET turns ON.

Over Temperature Protection (OTP)

During overload conditions, the output voltage drops with the limited current I_{LIM} . It results in the increasing junction temperature T_J with the increased power consumption on device. When T_J reaches to the thermal shutdown threshold T_{SHDN} , the internal power MOSFET is turned OFF. The internal MOSFET is turned ON again once the condition $[T_J < (T_{SHDN} - T_{HYS})]$ occurs.

Over Current Protection (OCP)

The output current is monitored continuously. Whenever the output current I_{OUT} is found to be larger than the I_{LIM} value by over $2\mu s$, the embedded overcurrent protection (OCP) fault-handling mechanism is triggered. This trigger results in the output current clamping at the I_{LIM} value at hundreds of ms later, and the voltage dropping at OUT port. The I_{LIM} value is set by R_{LIM} .

$$I_{LIM} = 100 / R_{LIM}$$

Where:

- I_{LIM} is in A
- R_{LIM} is in $k\Omega$
- $18k\Omega \leq R_{LIM} \leq 200k\Omega$

$R_{LIM} (k\Omega)$	$I_{LIM} (A)$		
	Min	Typ	Max
50	1.70	2.00	2.30
40	2.2	2.50	2.8
33.3	2.7	3.00	3.3
28.6	3.15	3.50	3.85
25	3.6	4	4.4
20	4.5	5	5.5

Short-Circuit Protection (SCP)

There are two behaviors to protect device under short-circuit conditions. One is fast-trip current detection. When the output current exceeds the fast-trip threshold $I_{FASTrip}$, the device switches OFF the internal MOSFET.

$$I_{FASTrip} = 1.125 \times I_{LIM} + 1.8$$

Where:

- $I_{FASTrip}$ and I_{LIM} is in A

Another is low output voltage detection. During heavy overload or short-circuit conditions, the output current is limited to I_{LIM} , and the output voltage drops quickly. When the output voltage drop is exceeded the capability of MOSFET, the power switch turns OFF. The device is operating in auto-retry mode, and the cycle time is around 128ms.

Application Information (continued)

Adjustable Current Monitoring Output (IMON)

A 100pF capacitor and a resistor R_{IMON} connected in parallel between the IMON pin and GND generate an average current monitor output voltage V_{IMON} , which is proportional to the load current flowing through the device,

$$V_{IMON} = 10^{-3} \times G_{IMON} \times R_{IMON} \times I_{OUT}$$

Where:

- G_{IMON} is the ratio of the IMON to the load current in $\mu A/A$ and $G_{IMON} = 10$
- V_{IMON} is in V
- R_{IMON} is in $k\Omega$
- I_{OUT} is in A

The resistor R_{IMON} must be chosen to ensure that the voltage at the IMON pin is less than $V_{IN} - 0.5V$ under the maximum load current I_{LIM} . For example, if R_{IMON} is selected as $50k\Omega$, there will be a 0.5V output on IMON pin at 1A load, and $V_{IMON} = 1.5V$ at 3A load. Connecting this IMON pin to an ADC can help to monitor the current information of a system.

Fault Response

An external pull-up resistor is required. The device generates a warning flag whenever one of the following fault conditions becomes valid: input overvoltage, reverse-voltage, over temperature, short-circuit, over current, ILIM pin short to ground. After a deglitch time-out of 7ms, the low-active FAULTB signal is asserted. The FAULTB signal remains at *low*, and the internal power MOSFET remains OFF until the device exits from the exception status.

Support of Fast Role Swap (FRS)

The DPS1135 is designed to support the Fast Role Swap (FRS) operation. This allows the system to change its role from being a power consumer to being a power provider within the time limit defined in the USB Power Delivery Specification Release 3.0 V1.0a. Irrespective of the voltage level at the EN pin, the relevant FRS control circuit inside the device is enabled at the rising edge of any positive pulse appearing at the FRS pin. When the pulse width (t_{FRS_ON}) is found to be larger than $600\mu s$, the internal power MOSFET shall be turned ON within $60\mu s$ from the falling edge of the pulse in the absence of the reverse-voltage condition. At the end of the $60\mu s$, the voltage level at the OUT port shall be of 90% of the voltage level at the IN port. Thereafter, while a subsequent rising edge at the EN pin shall always be ignored, the occurrence of a falling edge shall disable the device. After the device shuts down, it will not resume proper operation until a rising edge appears at either the EN pin or the FRS pin.

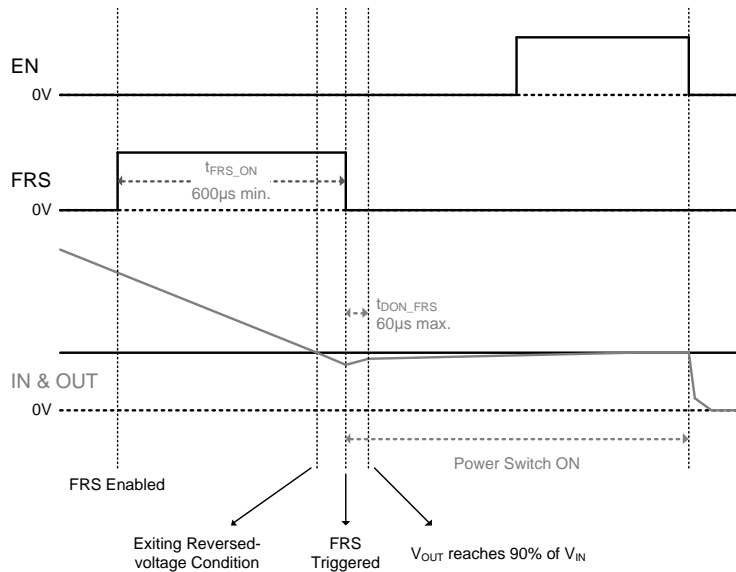

Figure 20. FRS Control Sequence for Fast Role Swap, Power Switch ON at Falling Edge of FRS Signal after Exiting RVP Condition

Application Information (continued)

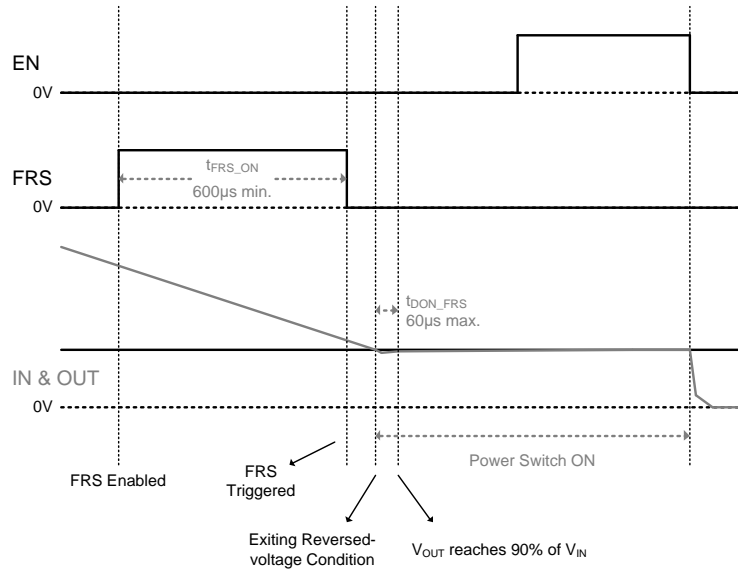

Figure 21. FRS Control Sequence for Fast Role Swap, Power Switch ON when Exiting RVP Condition after FRS is Triggered (Falling Edge)

Discharge Function

To facilitate the various applications envisioned by the system designers, the input or output port can be discharged via two external controls: DISC1 and DISC2. The internal discharge resistor at each port is approximately 100Ω. The discharge paths are OFF by default with an internal 1MΩ pull-down resistor between DISC1 (or DISC2) and GND. The settings are shown in the table below. The discharge is independent function with EN pin and DPS1135 status, it can be turned on any time when system need.

DISC1	DISC2	Description
0	0	Discharge Function Disabled
0	1	OUT Port is Discharged Until the Pin DISC2 is Pulled Low
1	0	IN Port is Discharged Until the Pin DISC1 is Pulled Low
1	1	Both IN and OUT Ports are Discharged Simultaneously

Schottky Diode for Protection of Current Surge

When a cable is hot plugged in/out of the USB-C connector behind where the OUT port of the DPS1135 is connected, a large ground current can be seen at the OUT port of the DPS1135. When the far end of a connected cable is short to ground, the OUT port of the DPS1135 could also see a large ground current. With the Schottky diode, SBR3U40P1, populated as close as possible to the USB-C connector, no ground current can go through the DPS1135 to cause false operation.

Application Information (continued)

PCB Layout Consideration

1. Place the input/output capacitors C_{IN} and C_{OUT} as close as possible to the IN and OUT pins.
2. The power traces, including the power ground, the V_{IN} trace, and the V_{OUT} trace, must be kept direct, short and wide.
3. Place the resistors and capacitors (R_{VLIM} , R_{ILIM} , R_{IMON} , C_{IMON} , $C_{DV/DT}$, and C_{VREG}) near the device pins.
4. Connect the signal ground to the GND pin, and keep a single connection from GND pin to the power ground behind the input or output capacitors.
5. For better power dissipation, via holes are recommended to connect the exposed pad's landing area to a large copper polygon on the other side of the PCB. The copper polygons and exposed pad of SRC (common source nodes of internal power MOSFET) must not be connected to any of the signal and power grounds on the PCB.

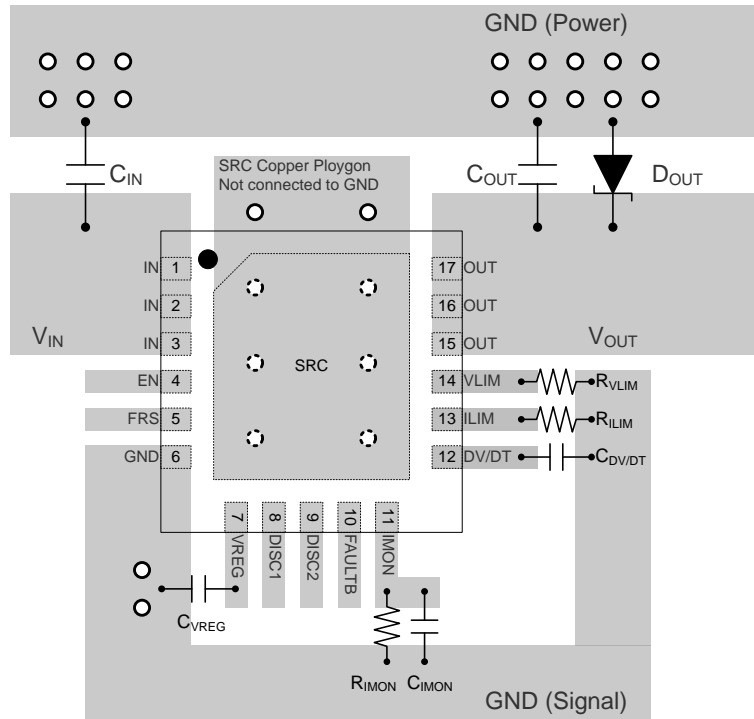

Figure 22. Suggested PCB Layout

OUT Pin Negative Voltage Consideration

In order to prevent the DPS1135 output pin from damage, a Schottky diode *Dout* is recommended at the output to clamp the negative voltage when output encounters short circuit condition. Table below shows the clamped voltages of various SBR diodes. These diodes are suitable for the DPS1135 applications.

OUT Undershoot Voltage (V)				
—	NC	3A DIODE (SBR3U40P1)	5A DIODE (SBR5E45P5)	10A DIODE (SBR10E45P5)
Eload	-2.76	-0.604	-0.462	-0.372
Rocker Switch	-2.43	-0.915	-0.636	-0.6

*Test setup: using the DPS1135 DEMO board, VIN = 5V, Eload WINSTEK PEL2040, Rocker switch

Ordering Information (Note 6)

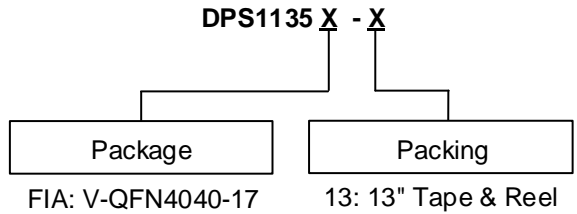

Part Number	Package	Marking ID	Reel Size (Inches)	Tape Width (mm)	Packing	
					Qty.	Carrier
DPS1135FIA-13	V-QFN4040-17	DPS1135	13	12	4,000	13" Tape & Reel

Note: 6. For packaging details, go to our website at <https://www.diodes.com/design/support/packaging/diodes-packaging/>.

Marking Information

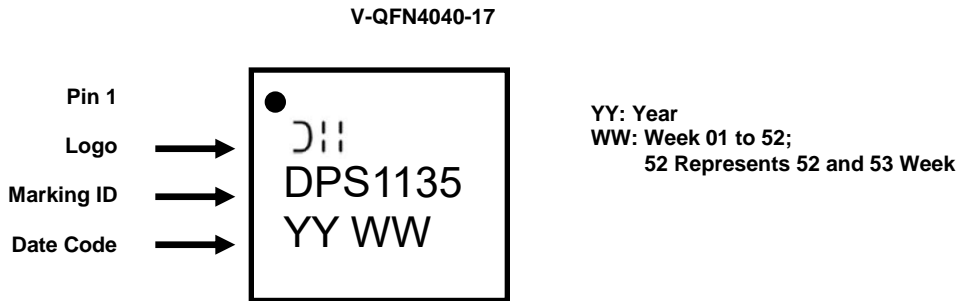

Package Outline Dimensions

Please see <http://www.diodes.com/package-outlines.html> for the latest version.

V-QFN4040-17

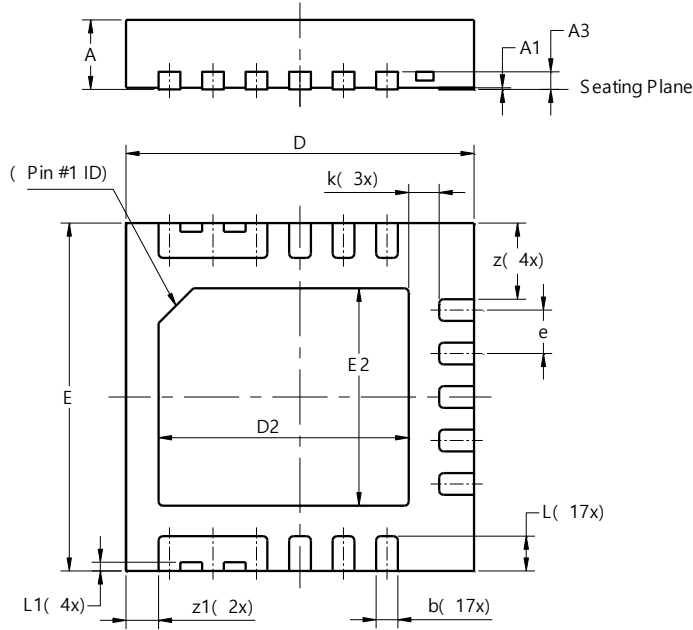

V-QFN4040-17			
Dim	Min	Max	Typ
A	0.75	0.85	0.80
A1	0.00	0.05	0.02
A3	-	-	0.203
b	0.20	0.30	0.25
D	3.95	4.05	4.00
D2	2.775	2.975	2.875
E	3.95	4.05	4.00
E2	2.40	2.60	2.50
e	0.50 BSC		
k	-	-	0.35
L	0.35	0.45	0.40
L1	-	-	0.10
z	-	-	0.875
z1	-	-	0.375
All Dimensions in mm			

Suggested Pad Layout

Please see <http://www.diodes.com/package-outlines.html> for the latest version.

V-QFN4040-17

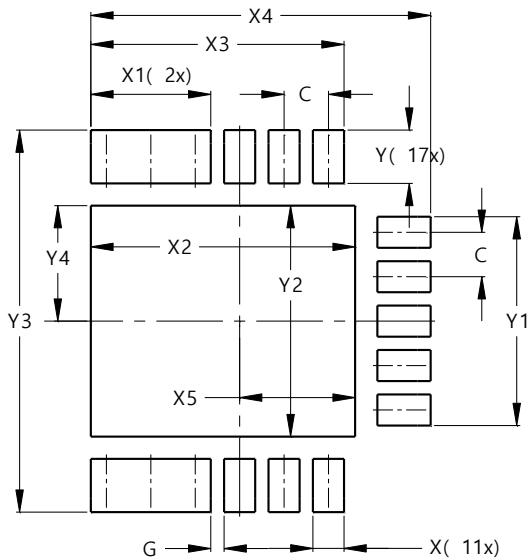

Dimensions	Value (in mm)
C	0.500
G	0.150
X	0.350
X1	1.350
X2	2.975
X3	2.850
X4	3.825
X5	1.300
Y	0.600
Y1	2.350
Y2	2.600
Y3	4.300
Y4	1.300

Mechanical Data

- Moisture Sensitivity: Level 1 per J-STD-020
- Terminals: NiPdAu Finish, Solderable per MIL-STD-202, Method 208^④
- Weight: 0.0375 grams (Approximate)

IMPORTANT NOTICE

1. DIODES INCORPORATED (Diodes) AND ITS SUBSIDIARIES MAKE NO WARRANTY OF ANY KIND, EXPRESS OR IMPLIED, WITH REGARDS TO ANY INFORMATION CONTAINED IN THIS DOCUMENT, INCLUDING, BUT NOT LIMITED TO, THE IMPLIED WARRANTIES OF MERCHANTABILITY, FITNESS FOR A PARTICULAR PURPOSE OR NON-INFRINGEMENT OF THIRD PARTY INTELLECTUAL PROPERTY RIGHTS (AND THEIR EQUIVALENTS UNDER THE LAWS OF ANY JURISDICTION).
2. The Information contained herein is for informational purpose only and is provided only to illustrate the operation of Diodes' products described herein and application examples. Diodes does not assume any liability arising out of the application or use of this document or any product described herein. This document is intended for skilled and technically trained engineering customers and users who design with Diodes' products. Diodes' products may be used to facilitate safety-related applications; however, in all instances customers and users are responsible for (a) selecting the appropriate Diodes products for their applications, (b) evaluating the suitability of Diodes' products for their intended applications, (c) ensuring their applications, which incorporate Diodes' products, comply the applicable legal and regulatory requirements as well as safety and functional-safety related standards, and (d) ensuring they design with appropriate safeguards (including testing, validation, quality control techniques, redundancy, malfunction prevention, and appropriate treatment for aging degradation) to minimize the risks associated with their applications.
3. Diodes assumes no liability for any application-related information, support, assistance or feedback that may be provided by Diodes from time to time. Any customer or user of this document or products described herein will assume all risks and liabilities associated with such use, and will hold Diodes and all companies whose products are represented herein or on Diodes' websites, harmless against all damages and liabilities.
4. Products described herein may be covered by one or more United States, international or foreign patents and pending patent applications. Product names and markings noted herein may also be covered by one or more United States, international or foreign trademarks and trademark applications. Diodes does not convey any license under any of its intellectual property rights or the rights of any third parties (including third parties whose products and services may be described in this document or on Diodes' website) under this document.
5. Diodes' products are provided subject to Diodes' Standard Terms and Conditions of Sale (<https://www.diodes.com/about/company/terms-and-conditions/terms-and-conditions-of-sales/>) or other applicable terms. This document does not alter or expand the applicable warranties provided by Diodes. Diodes does not warrant or accept any liability whatsoever in respect of any products purchased through unauthorized sales channel.
6. Diodes' products and technology may not be used for or incorporated into any products or systems whose manufacture, use or sale is prohibited under any applicable laws and regulations. Should customers or users use Diodes' products in contravention of any applicable laws or regulations, or for any unintended or unauthorized application, customers and users will (a) be solely responsible for any damages, losses or penalties arising in connection therewith or as a result thereof, and (b) indemnify and hold Diodes and its representatives and agents harmless against any and all claims, damages, expenses, and attorney fees arising out of, directly or indirectly, any claim relating to any noncompliance with the applicable laws and regulations, as well as any unintended or unauthorized application.
7. While efforts have been made to ensure the information contained in this document is accurate, complete and current, it may contain technical inaccuracies, omissions and typographical errors. Diodes does not warrant that information contained in this document is error-free and Diodes is under no obligation to update or otherwise correct this information. Notwithstanding the foregoing, Diodes reserves the right to make modifications, enhancements, improvements, corrections or other changes without further notice to this document and any product described herein. This document is written in English but may be translated into multiple languages for reference. Only the English version of this document is the final and determinative format released by Diodes.
8. Any unauthorized copying, modification, distribution, transmission, display or other use of this document (or any portion hereof) is prohibited. Diodes assumes no responsibility for any losses incurred by the customers or users or any third parties arising from any such unauthorized use.
9. This Notice may be periodically updated with the most recent version available at <https://www.diodes.com/about/company/terms-and-conditions/important-notice>

The Diodes logo is a registered trademark of Diodes Incorporated in the United States and other countries.
All other trademarks are the property of their respective owners.
© 2023 Diodes Incorporated. All Rights Reserved.

www.diodes.com