

NO.	MASSE / DIMENSIO
A	53.4
B	31.6
C	53

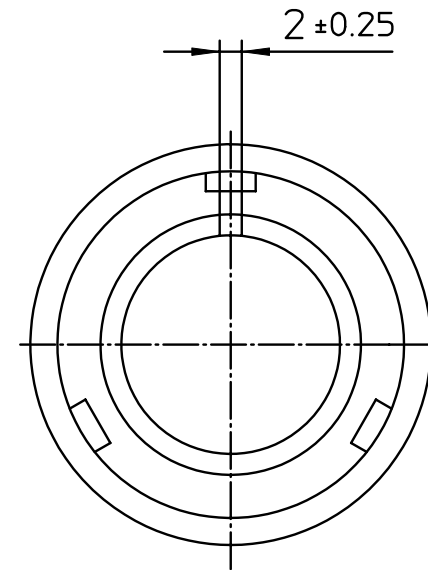

NO.	BESCHREIBUNG / DESCRIPTION
2	ISOLIERKÖRPER BUCHSE / INSULATOR SOCKET
3	DICHTKÖRPER / GROMMET
4	ENDRING / ENDRING
6	KONTAKTBUCHSE / CONTACT SOCKET
7	ZYLINDERGHÄUSE / BARREL
9	ÜBERWURFMUTTER / COUPLING NUT
10	DICHTRING FRONT / FRONT SEALING RING
20	KURZES ENDGEHÄUSE/SHORT ENDBELL

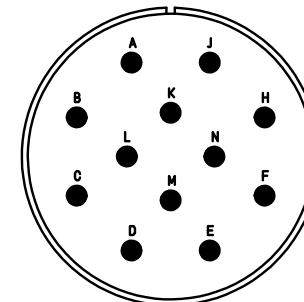

Note: Due to an automatic nomenclature system, numbers generated may not be sequential.  
 Specification and Dimensions subject to change  
 Drawings illustrate normal insulator positioning

Material Specification:	
Shell Material:	Aluminium alloy
Shell Plating:	Olive drab chromate over cadmium (conductive)
Insulator Material:	CR-Elastomere
Contact Material:	Copper alloy
Contact Plating:	Hard silver

all dimensions are in mm  
 Dimensions without tolerance indications are general tolerances in acc. with DIN7168m  
 drawing for CUSTOMER



description CA3106R28-51S-B-F80  
 Plug, straight  
 Shortened light-weight endbell without cable clamp  
 AWG Crimp / Socket / Layout: 28-51

© All rights reserved. Reproduction or issue to third in any form  
 whatever is only permitted with written authorization of ITT Cannon  
 page 1/1  
 revision 1730 14. May 19