

# Features

- 400/450 Watt convection cooled (115/230VAC)
- 600 Watt forced air or peak power
- 5VSB Output
- Redundant operation; active current sharing
- Remote sensing, CTRL ON/OFF, PMBus™
- IEC60601-1 2x MOPP insulation, BF-ready

# Regulated Converter

## RACM600-L

**600 Watt**  
**7.7" x 4"**



**Open Frame**  
**Single Output**

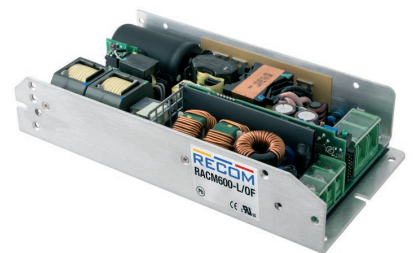

### Description

RACM600-L/OF Series AC/DC power supply units are designed for operation in natural convection and in systems with certain airflow ventilation to deliver 400 to 600Watt output power. Safety approvals to Medical IEC 60601-1-2 and to IT and industrial IEC 62368 standards and operation with worldwide input voltage conditions from 80 to 275Vac in altitudes up to 5000m make these chassis mount units ideal for global use in medical, industrial or IT related automation processes. For enhanced reliability requirements of applications redundant operation is supported with active current sharing. An additional 5V Standby output powers housekeeping circuitry to control remote on/off and monitoring functions which are available via PMBus™ I<sup>2</sup>C interface. EN55032 class "B" EMC compliance is achieved without any external components which underlines the versatility of these power supplies.

### Selection Guide

Part Number	Input Voltage Range [VAC]	Nom. Output Voltage [VDC]	Max. Output Current <sup>(1)</sup> [A]	Efficiency typ. <sup>(2)</sup> [%]
RACM600-12SL/OF	80-275	12	66.67	92
RACM600-24SL/OF	80-275	24	25	93
RACM600-48SL/OF	80-275	48	16.67	93

#### Notes:

Note1: Refer to "Peak Load Capability"

Note2: Efficiency is tested at 230VAC and full load at +25°C ambient

### Model Numbering



IEC/EN62368-1 certified  
UL62368-1 certified  
CSA/CAN C22.2 No. 62368-1 certified  
ANSI/AAMI ES60601-1 certified  
CSA/CAN C22.2 No. 60601-1:14 certified  
IEC/EN60601-1 certified  
EN55032 compliant  
EN55024 compliant  
EN60601-1-2 compliant  
CB Report

### Specifications (measured @ Ta= 25°C, nom. Vin, full load and after warm-up unless otherwise stated)

BASIC CHARACTERISTICS				
Parameter	Condition	Min.	Typ.	Max.
Nominal Input Voltage	50/60Hz	100VAC		240VAC
Operating Range <sup>(3,4)</sup>	47-63Hz	80VAC		275VAC
	DC	120VDC		300VDC
Input Current	RACM600-24SL/OF	80VAC		9A
		120VDC		5.7A
	RACM600-12SL/OF; RACM600-48SL/OF	80VAC		11.4A
		120VDC		7.6A
Inrush Current	cold start at 25°C			20A
Input Frequency Range	AC Input	47Hz		63Hz
Minimum Load		0%		
Power Factor	EN61000-3-2, Class A compliant		0.9	
Start-up Time	MAIN ON			2.5s
	CTRL ON			150ms
Rise Time				150ms
Hold-up Time			20ms	
Periodic and Random Deviation (PARD)	20MHz BW, 10µF Tan. and 1µF MLCC			1%p-p
<b>Notes:</b>				
Note3: The products were submitted for safety files at AC and DC-Input operation.				
Note4: Refer to "Rating Graphs of continuous Operation"				

Specifications (measured @ Ta= 25°C, nom. Vin, full load and after warm-up unless otherwise stated)

RACM600-24SL/OF

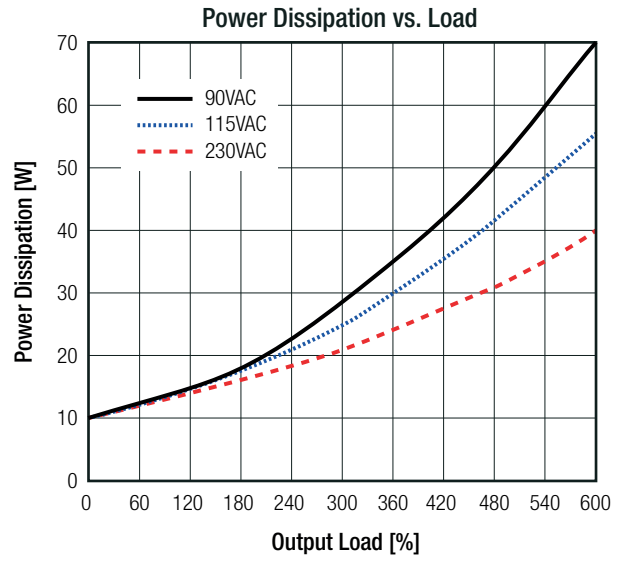
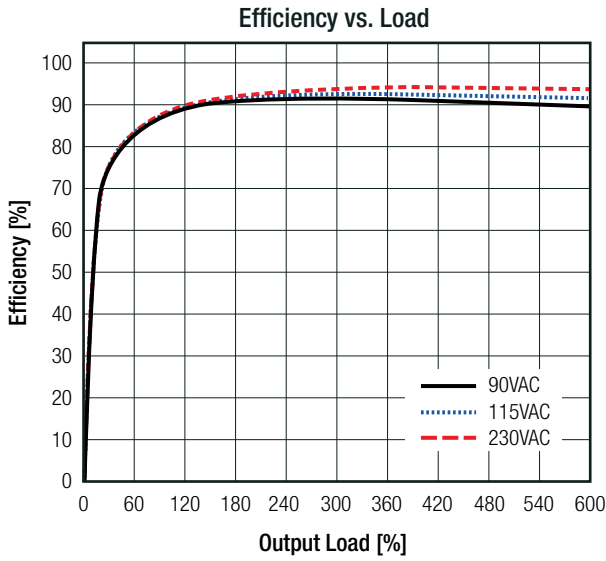

RACM600-12SL/OF

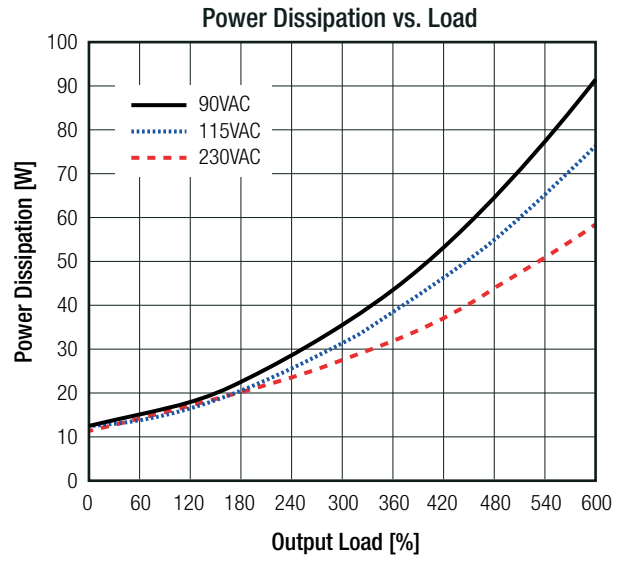
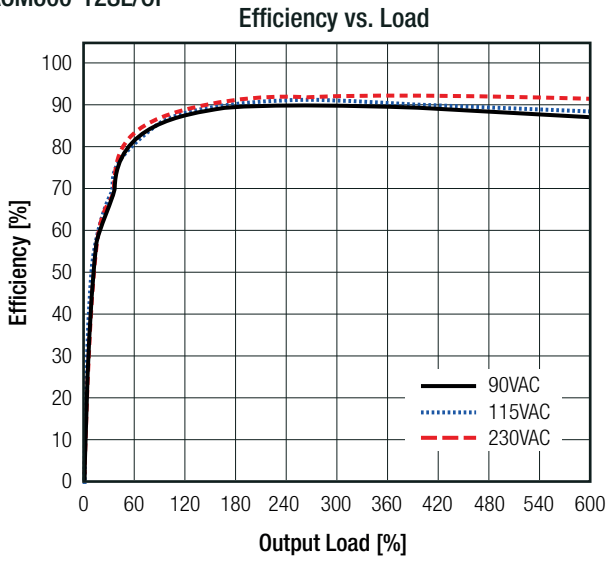

RACM600-12SL/OF

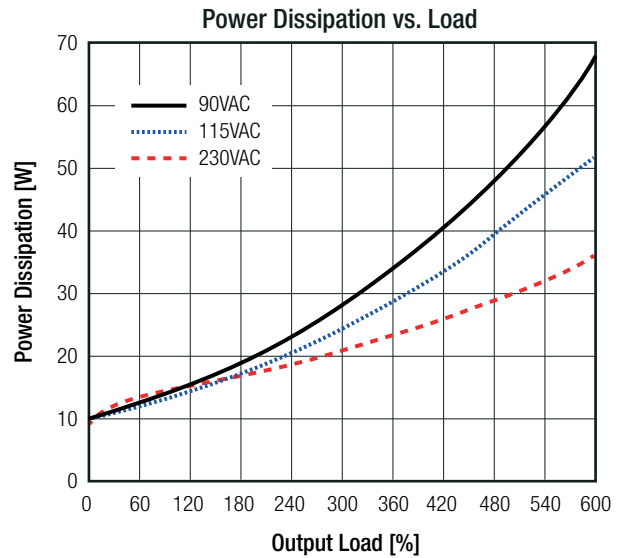
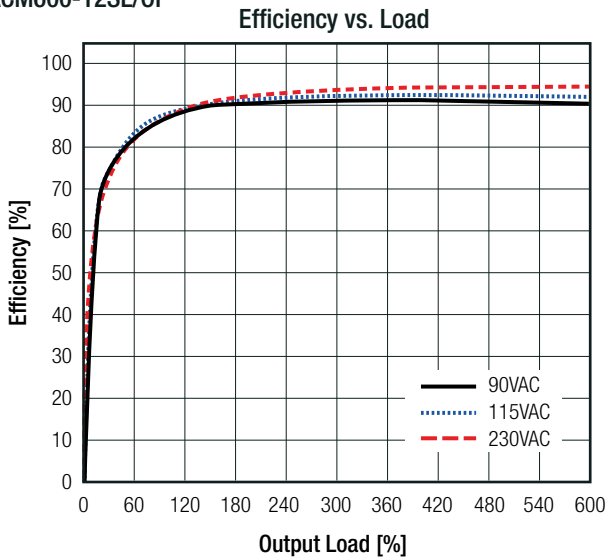

**Specifications** (measured @ Ta= 25°C, nom. Vin, full load and after warm-up unless otherwise stated)

**ADDITIONAL FEATURES**

Parameter	Condition		Min.	Typ.	Max.
ON/OFF CTRL (logic can be switched with PMBus™)	CON3	MAIN OUTPUT ON	open		
		MAIN OUTPUT OFF	CTRL (pin10) shorted to 5VSB_RTN (pin3,4,7)		
Output Voltage Adjustability <sup>(5)</sup>	on-board poti, refer to “Output Current vs. Output Voltage”	RACM600-12SL/OF	9.6VDC		14.4VDC
		RACM600-24SL/OF	19.2VDC		28.8VDC
		RACM600-48SL/OF	38.4VDC		56VDC
Remote Sense <sup>(6)</sup>	total voltage drop compensation for +Sense and -Sense connection				200mV
Power OK LED	LED = green		turn ON as soon as PSU_GOOD Signal is set to high		

**Notes:**

Note5: Make sure that the maximum rated output power will not be exceeded when trimming up as well.

Note6: Do not short or reversely connect +Sense to -Sense, this can cause damage to the supply

**Output Current vs. Output Voltage**

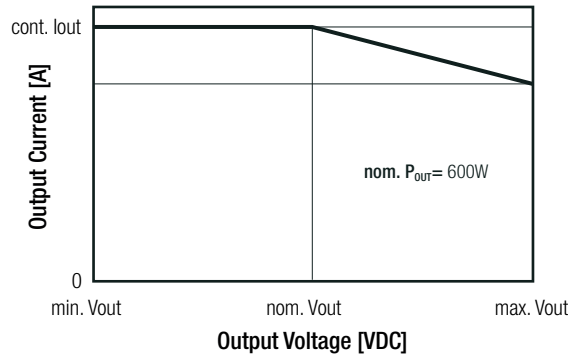

Model	min. Vout	nom. Vout	max Vout	max. cont. Iout
RACM600-12SL/OF	9.6VDC	12VDC	14.4VDC	50A
RACM600-24SL/OF	19.2VDC	24VDC	28.8VDC	25A
RACM600-48SL/OF	38.4VDC	48VDC	56VDC	12.5A

**5VSB OUTPUT <sup>(7)</sup>**

Parameter	Condition	Min.	Typ.	Max.
Nominal Output Voltage				5VDC
Max. Output Current				500mA
Max. Output Power				2.5W
Max. Capacitive Load				1000µF
Over Voltage Protection (OVP)				5.5-6VDC, latch off
Over Current Protection (OCP)	of rated I <sub>OUT</sub>			1-1.3A, auto recovery
Short Circuit Protection (SCP)				auto recovery
Over Temperature Protection (OTP)				auto recovery

**Notes:**

Note7: There is no galvanic isolation between AUX GND and Main Output GND. Regulations for 5VSB Output are stated under “REGULATIONS”

**REGULATIONS**

Parameter	Condition	Value
Output Accuracy (MAIN and 5VSB output)		±2.25% max.
Line Regulation (MAIN and 5VSB output)	low line to high line, full load	±0.25% typ.
Load Regulation (MAIN and 5VSB output)	0% to 100% load	1.0% typ.
Dynamic Load Regulation	50% step from 5% load (1A/µs), tested with 10µF Tan. and 1µF MLCC	5.0% max.

**Specifications** (measured @ Ta= 25°C, nom. Vin, full load and after warm-up unless otherwise stated)

PROTECTIONS			
Parameter	Type		Value
Internal Input Fuse	DC input compliant, dual-fusing	RACM600-24SL/OF	2x T10A
		others	2x F12.5A
Short Circuit Protection (SCP)			hiccup, auto recovery
Over Voltage Protection (OVP)	RACM600-12SL/OF		15VDC - 17.5VDC, latch off
	RACM600-24SL/OF		30VDC - 35VDC, latch off
	RACM600-48SL/OF		58.5VDC - 63VDC, latch off
Over Voltage Category (OVC)			OVCII
Over Current Protection (OCP)	RACM600-24SL/OF		108-140%, auto recovery
	RACM600-12SL/OF; RACM600-48SL/OF		105-120%, auto recovery
Over Temperature Protection (OTP)			auto recovery
Isolation Voltage (safety certified) <sup>(8)</sup>	1 minute	I/P to O/P (reinforced)	4kVAC (2MOPP)
		I/P and O/P to Case (basic)	1.5kVAC (1MOPP)
Insulation Grade			reinforced
Leakage Current Input to Earth GND	low line 132VAC , 63Hz	Normal condition	150µA max.
		Single Fault	250µA max.
	high line 264VAC , 60Hz	Normal condition	300µA max.
		Single Fault	500µA max.
Leakage Current Output to Earth GND	264VAC , 63Hz	Normal condition	60µA max.
		Single Fault (neutral open)	80µA max.
		Single Fault (ground open)	150µA max.
		AC Back-drive Fault	550µA max.
Class of Equipment			Class I
Medical Device Classification	according to IEC60601-1		designed to support Type BF applied part
<p><b>Notes:</b></p> <p>Note8: For repeat Hi-Pot testing, reduce the time and/or the test voltage</p>			

ENVIRONMENTAL			
Parameter	Condition		Value
Operating Temperature Range	refer to "Rating Graphs of continuous Operation"	T <sub>BASE</sub> temperature	-20°C to +70°C
Operating Altitude <sup>(9)</sup>	according to 62368-1		5000m
	according to 60601-1		3000m
Operating Humidity	non-condensing		95% max.
Pollution Degree			PD2
Vibration (non-operating)	2.09Gr.m.s., 5Hz to 500Hz, 20 minutes per side (3 planes)		according to IEC 60068-2-6
Shock (non-operating)	50G, 11ms, 3 shocks for each direction		according to IEC 60068-2-27
MTBF	according to Telcordia SR-332, Issue 3, 25°C ambient, 90% confidence level		500 x 10 <sup>3</sup> hours
Design Lifetime (capacitor)	nom. Vin, 80% load, 45°C ambient		87.6 x 10 <sup>3</sup> hours
<p><b>Notes:</b></p> <p>Note9: Recognized by safety agency for safe operation up to 5000m. High altitude operation may impact the performance and lifetime Ambient temperature decreases by 1°C per 305m altitude increase</p>			
continued on next page			

Specifications (measured @ Ta= 25°C, nom. Vin, full load and after warm-up unless otherwise stated)

**RATING GRAPHS OF CONTINUOUS OPERATION**

**RACM600-24SL/OF (600W max. Peak Power)**

**200-240VAC (±10%)**

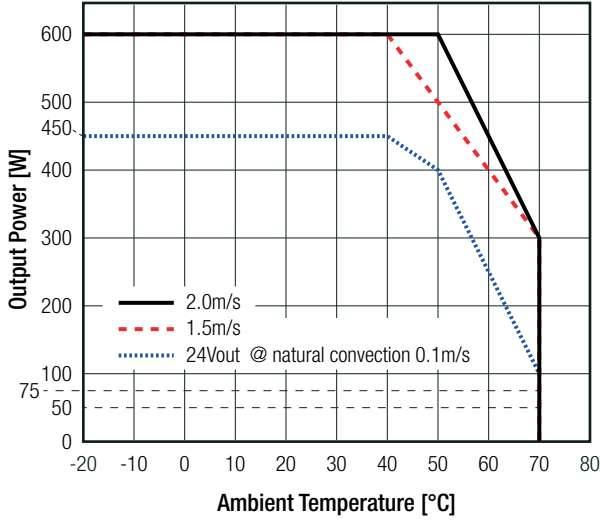

Ambient Temperature [°C]

**115VAC (±10%)**

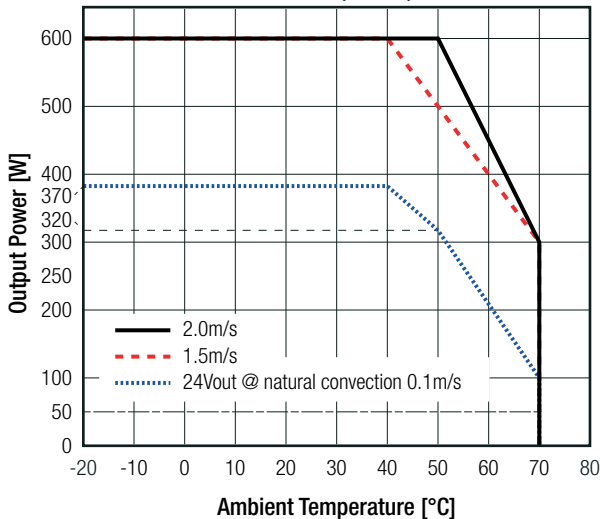

Ambient Temperature [°C]

**100VAC (±10%)**

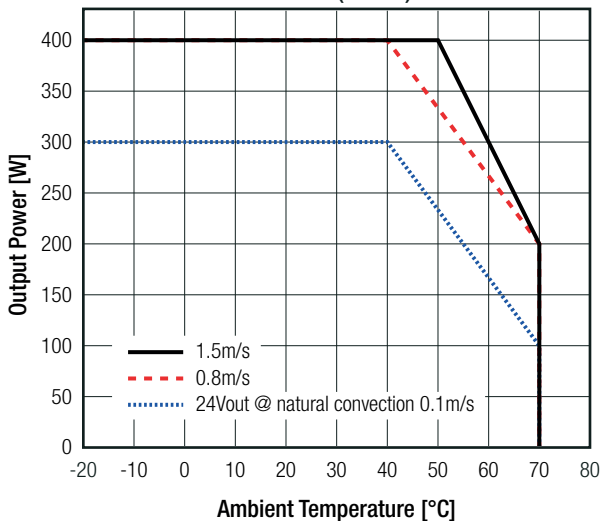

Ambient Temperature [°C]

**RACM600-12SL/OF & RACM600-48SL/OF (800W max. Peak Power)**

**200-240VAC (±10%)**

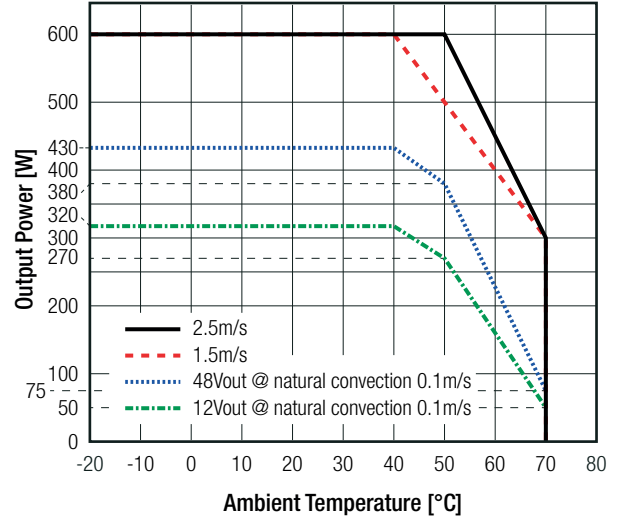

Ambient Temperature [°C]

**115VAC (±10%)**

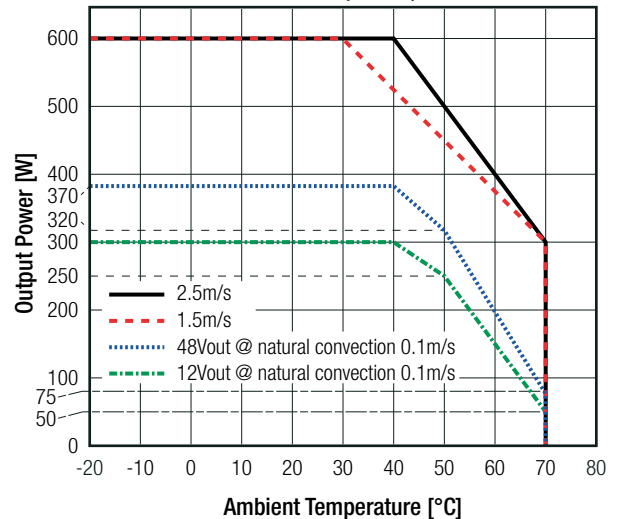

Ambient Temperature [°C]

**100VAC (±10%)**

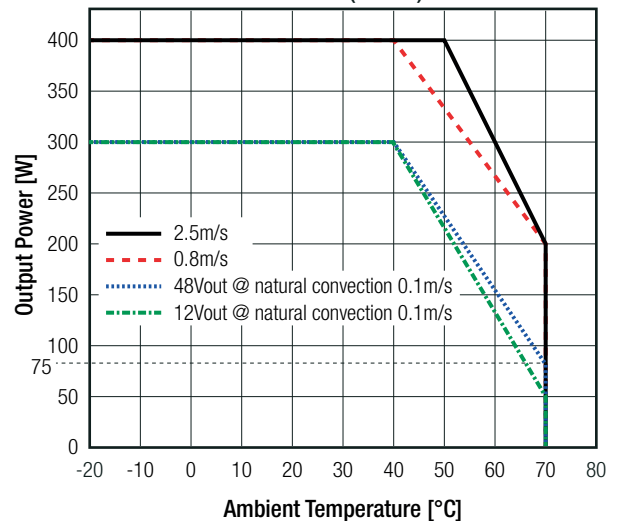

Ambient Temperature [°C]

Output power derating for Line-input of less than 90VAC. De-rate linearly from 100% at 90VAC to 80% at 80VAC to given thermal ratings

**Specifications** (measured @ Ta= 25°C, nom. Vin, full load and after warm-up unless otherwise stated)

**PEAK LOAD CAPABILITY**

**Guideline for sporadically occurring peak loads (RACM600-12(48)SL/OF):**

800 Watt max. @ 40°C ambient with a maximum duty cycle of:

0.5% .. for still air convection

4% ... at 1.5m/s provided system airflow

**Calculation Guideline for recurrent dynamic load cycles:**

Peak Load calculation for recurrent dynamic loading		Peak Load calculation for still air convection			Peak Load Capability with 1.5m/s airflow
Parameters	Units	RACM600-12SL/OF	RACM600-48SL/OF	RACM600-24SL/OF	RACM600-12(48)SL/OF
P <sub>nom</sub> = rated output power	[W]	refer to "Rating Graphs of continuous Operation"			
P <sub>p</sub> = peak output power	[W]	≤800	≤800	≤600	≤800
P <sub>r</sub> = recovery output power	[W]	use calculation below			
t <sub>1</sub> = peak time set	[s]	≤5s	≤5s	≤5s	≤10s
t <sub>2</sub> = recovery time	[s]	min. 10 x t <sub>1</sub>	min. 8 x t <sub>1</sub>	min. 8 x t <sub>1</sub>	min. 6 x t <sub>1</sub>
k= heat dissipation factor	[ ]	2	2	2	1.2

Calculation: 
$$P_r = \frac{P_{nom} \times (t_1 + t_2) - (P_p \times t_1)}{t_2 \times k}$$

**Practical Example (RACM600-48SL/OF for still air convection):**

Take the RACM600-48SL/OF at 230VAC input Voltage and full load at T<sub>AMB</sub> = 50°C, with still air convection.

P<sub>p</sub> = 720W

P<sub>nom</sub> = 380W

t<sub>1</sub> = 4s

t<sub>2</sub> = 32s

k = 2

$$P_r = \frac{380 \times (4 + 32) - (720 \times 4)}{32 \times 2} = 169W$$

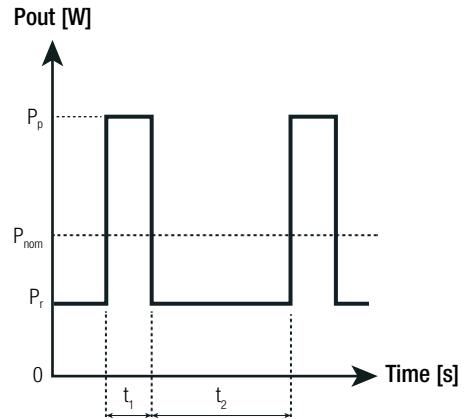

**SAFETY AND CERTIFICATIONS (12VOUT AND 48VOUT PENDING)**

Certificate Type (Safety)	Report Number	Standard
Audio/video, information and communication technology equipment. Safety requirements (CB)	T223-0662-21	IEC62368-1, 2nd Edition 2014
Audio/video, information and communication technology equipment. Safety requirements (LVD)		EN62368-1:2014 + A11:2017
Audio/Video, information and communication technology equipment - Part1: Safety requirements	E224736-A6026-UL	UL62368-1:2014 CAN/CSA-C22.2 No. 62368-1:2014
Medical Electric Equipment, General Requirements for Safety and Essential Performance	E314885-D1009-1/A0/C0-UL	ANSI/AAMI ES60601-1:2005A2:2010/(R)2012 CAN/CSA-C22.2 No. 60601-1:14, 3rd Edition
Medical electrical equipment Part 1: General requirements for basic safety and essential performance (CB Scheme)	T223-0661-21	IEC60601-1:2005, 3rd Edition + AM1:2012
Medical electrical equipment Part 1: General requirements for basic safety and essential performance		EN60601-1:2006 + A1:2013
RoHS2		RoHS 2011/65/EU

continued on next page

**Specifications** (measured @ Ta= 25°C, nom. Vin, full load and after warm-up unless otherwise stated)

EMC Compliance	Condition	Standard / Criterion
Electromagnetic compatibility of multimedia equipment – Emission Requirements		EN55032:2015
Information technology equipment - Immunity characteristics - Limits and methods of measurement		EN55024:2010+A1:2015
Medical electrical equipment Part 1-2: General requirements for basic safety and essential performance – Collateral Standard: Electromagnetic disturbances – Requirements and tests		EN60601-1-2:2015
ESD Electrostatic Discharge Immunity Test	Air: ±15kV Contact: ±4,8kV	EN61000-4-2, Criteria A
Radiated, Radio-Frequency, Electromagnetic Field Immunity Test	level 3= 10V/m	EN61000-4-3, Criteria A
Fast Transient and Burst Immunity	level 4= ±4kV	EN61000-4-4, Criteria A
Surge Immunity	level 4= ±2kV DM, ±4kV CM	EN61000-4-5, Criteria A
Immunity to Conducted Disturbances, Induced by Radio-Frequency Fields	level= 3, 6Vrms in ISM band	EN61000-4-6, Criteria A
Power Magnetic Field Immunity	30A/m	EN61000-4-8, Criteria A
Voltage Dips	30%, 500ms	EN61000-4-11, Criteria A
	60%, 100ms	EN61000-4-11, Criteria B
	100%, 20ms	EN61000-4-11, Criteria A
Voltage Interruptions	30%, 500ms	EN61000-4-11, Criteria A
	60%, 100ms	EN61000-4-11, Criteria B
	100%, 20ms	EN61000-4-11, Criteria A
	100%, 5000ms	EN61000-4-11, Criteria B
Ring wave immunity test	level 3= 1kV DM, 2kV CM	EN61000-4-12, Class A
Voltage fluctuation immunity test for equipment with input current <16 A per phase	class 3	EN61000-4-14, Class A
Limits of Harmonic Current Emissions		EN61000-3-2:2014
Voltage Fluctuations and Flicker in Public Low-Voltage Systems		EN61000-3-3:2013

**BLOCK DIAGRAM**

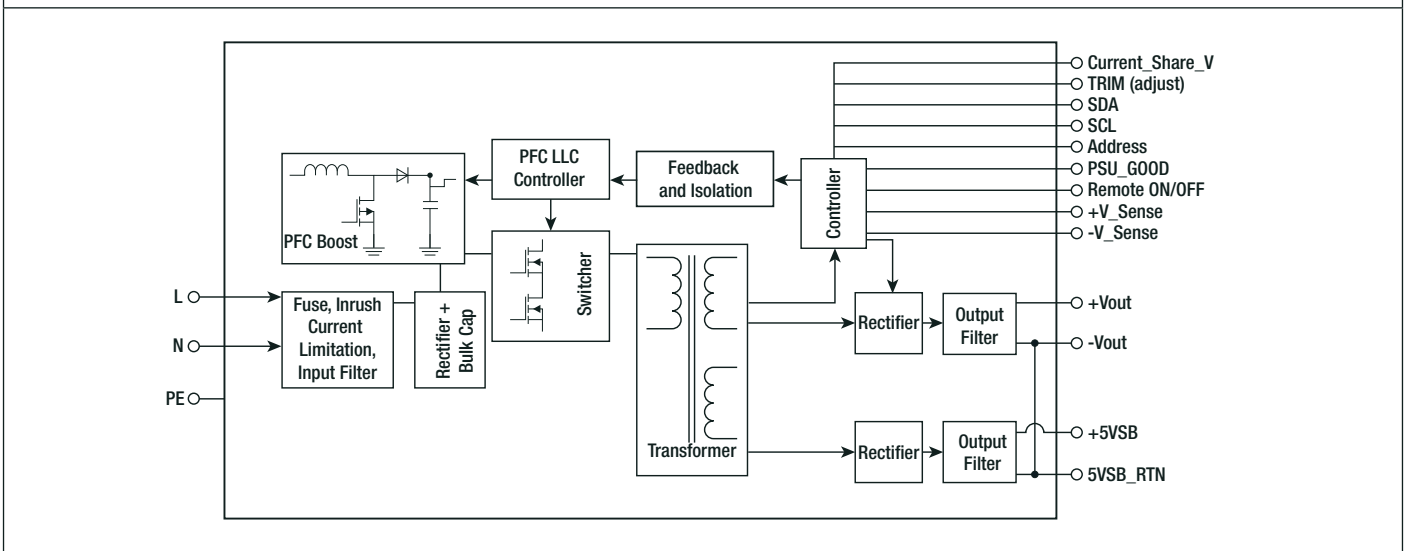

**DIMENSION AND PHYSICAL CHARACTERISTICS**

Parameter	Type	Value
Material	case/baseplate	aluminum
	PCB	FR4
Dimension (LxWxH)		196.8 x 101.6 x 40.6mm
Weight		1000g typ.

continued on next page



Specifications (measured @ Ta= 25°C, nom. Vin, full load and after warm-up unless otherwise stated)

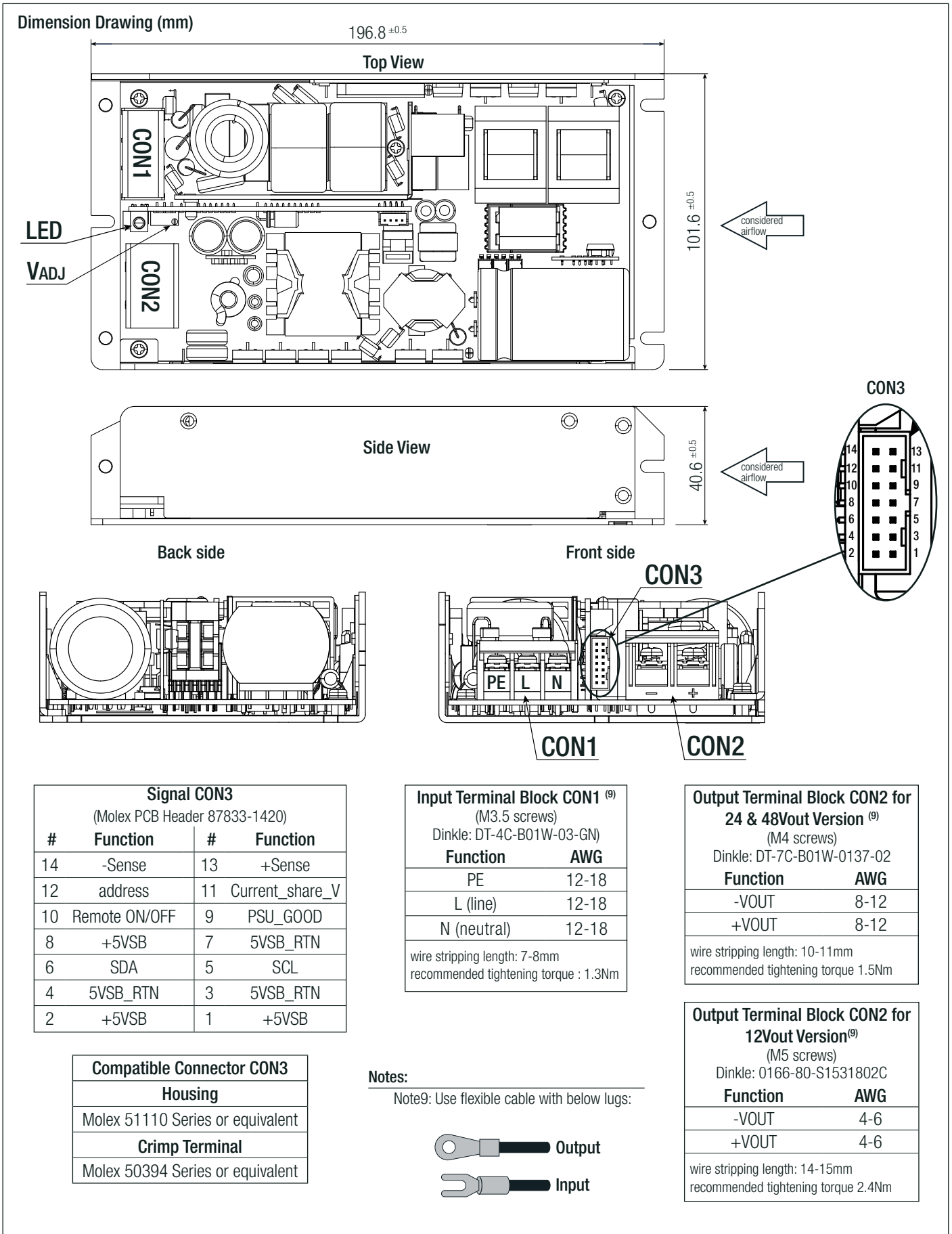



Specifications (measured @ Ta= 25°C, nom. Vin, full load and after warm-up unless otherwise stated)

**MOUNTING INSTRUCTIONS**

Mounting Dimensions

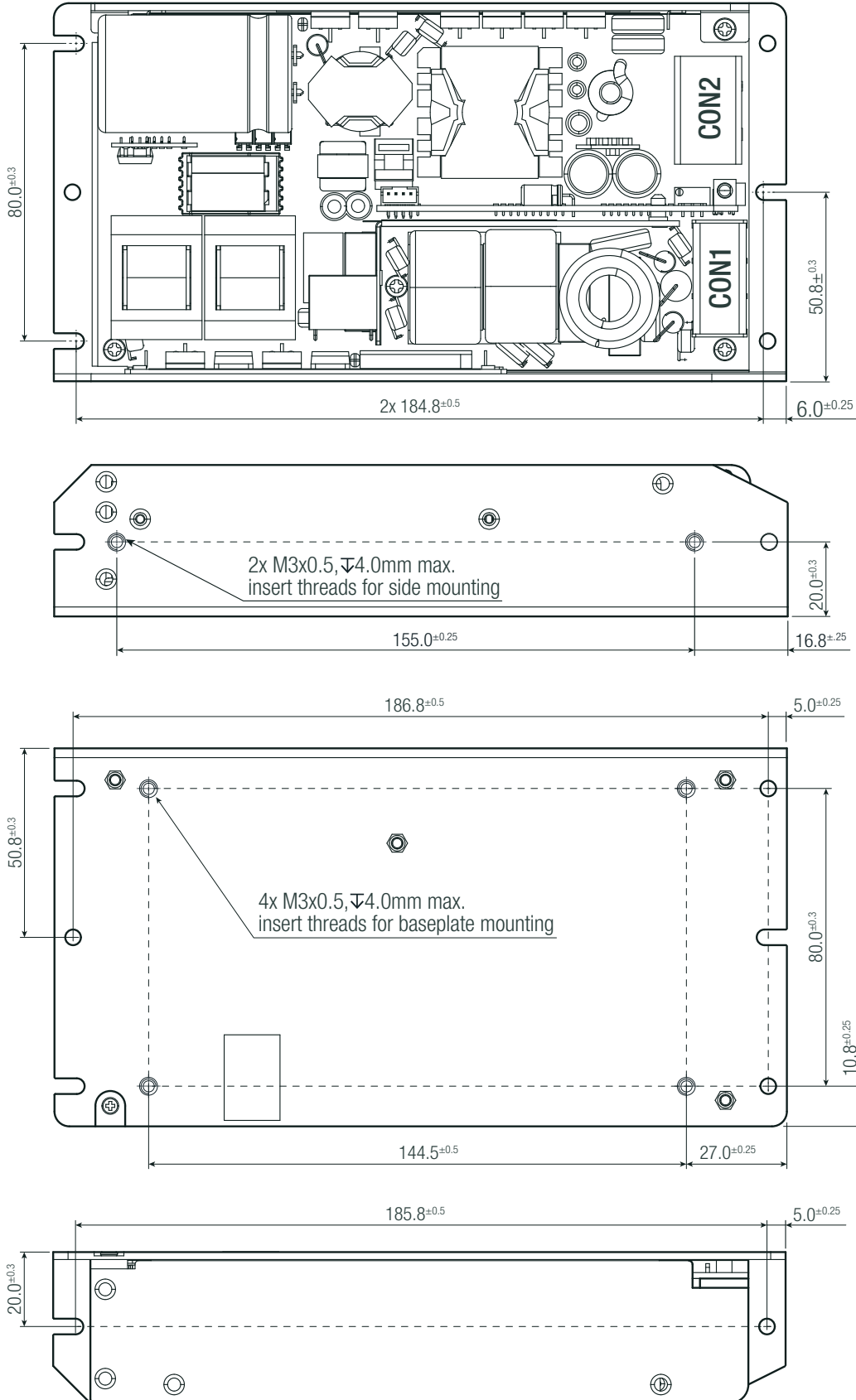

continued on next page

**Specifications** (measured @ Ta= 25°C, nom. Vin, full load and after warm-up unless otherwise stated)

**MOUNTING INSTRUCTIONS**

**Mounting Orientations**

vertical mounting

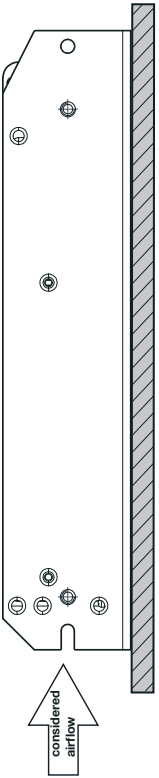

horizontal (standard) mounting



With forced air cooling, mounting orientation has no impact on output power. Upside down mounting is not recommended. Forced air conditions as specified are valid for indicated airflow direction only (back side). The PSU should be placed on a metal surface. It should not be placed on isolating and low thermal conductive surfaces. Take care that no objects can fall into the PSU.

**Mounting Equipment**

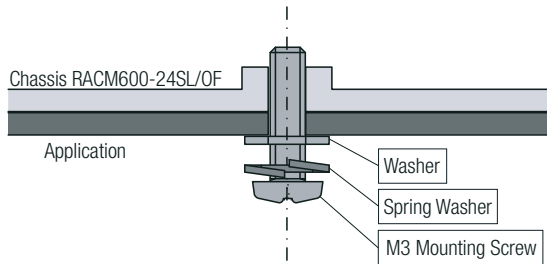

Recommended mounting tightening torque= 0.6Nm.  
Screw length= min. 2mm / max. 4mm

**PACKAGING INFORMATION**

Parameter	Type	Value
Packaging Dimension (LxWxH)	cardboard box	400.0 x 318.0 x 150mm
Packaging Quantity		7pcs
Storage Temperature Range		-40°C to +85°C
Storage Humidity	non-condensing	95% RH max.

The product information and specifications may be subject to changes even without prior written notice. The product has been designed for various applications; its suitability lies in the responsibility of each customer. The products are not authorized for use in safety-critical applications without RECOM's explicit written consent. A safety-critical application is an application where a failure may reasonably be expected to endanger or cause loss of life, inflict bodily harm or damage property. The applicant shall indemnify and hold harmless RECOM, its affiliated companies and its representatives against any damage claims in connection with the unauthorized use of RECOM products in such safety-critical applications.