

---

**IRU3038 EVALUATION BOARD USER GUIDE****INTRODUCTION**

The IRU3038 controller IC is designed to provide a low cost synchronous Buck regulator for voltage tracking applications such as DDR memory and general purpose on-board DC to DC converter. Modern micro processors combined with DDR memory, need high-speed bandwidth data bus which requires a particular bus termination voltage. This voltage will be tightly regulated to track the half of chipset voltage for best performance.

**SPECIFICATION DATA****Switcher:**

$$V_{IN} = 5V$$

$$V_{OUT} = 2.5V$$

$$I_{OUT} = 8A$$

$$\Delta V_{OUT} = 75mV$$

$$FS = 200KHz$$

---

**INPUT/OUTPUT CONNECTIONS**

The following is the input/output connections:

**Inputs:**

J1: Input (+5V)

J2: Gnd

**Outputs:**

J5:  $V_{OUT}$  (+2.5V)

J6: Gnd

**Other Connections:**

J7:  $V_{DDQ}$  (for tracking system)

J3:  $V_{REF}$  (output for reference voltage)

The connection points are shown in Figure 1. Connect the power supply cables according to this figure, minimize wire lengths to reduce losses in the wire. Test point J8 and J9 provide easy connections for oscilloscope voltage probe to monitor the output inductor point and the output voltages.

**CONNECTION DIAGRAM**

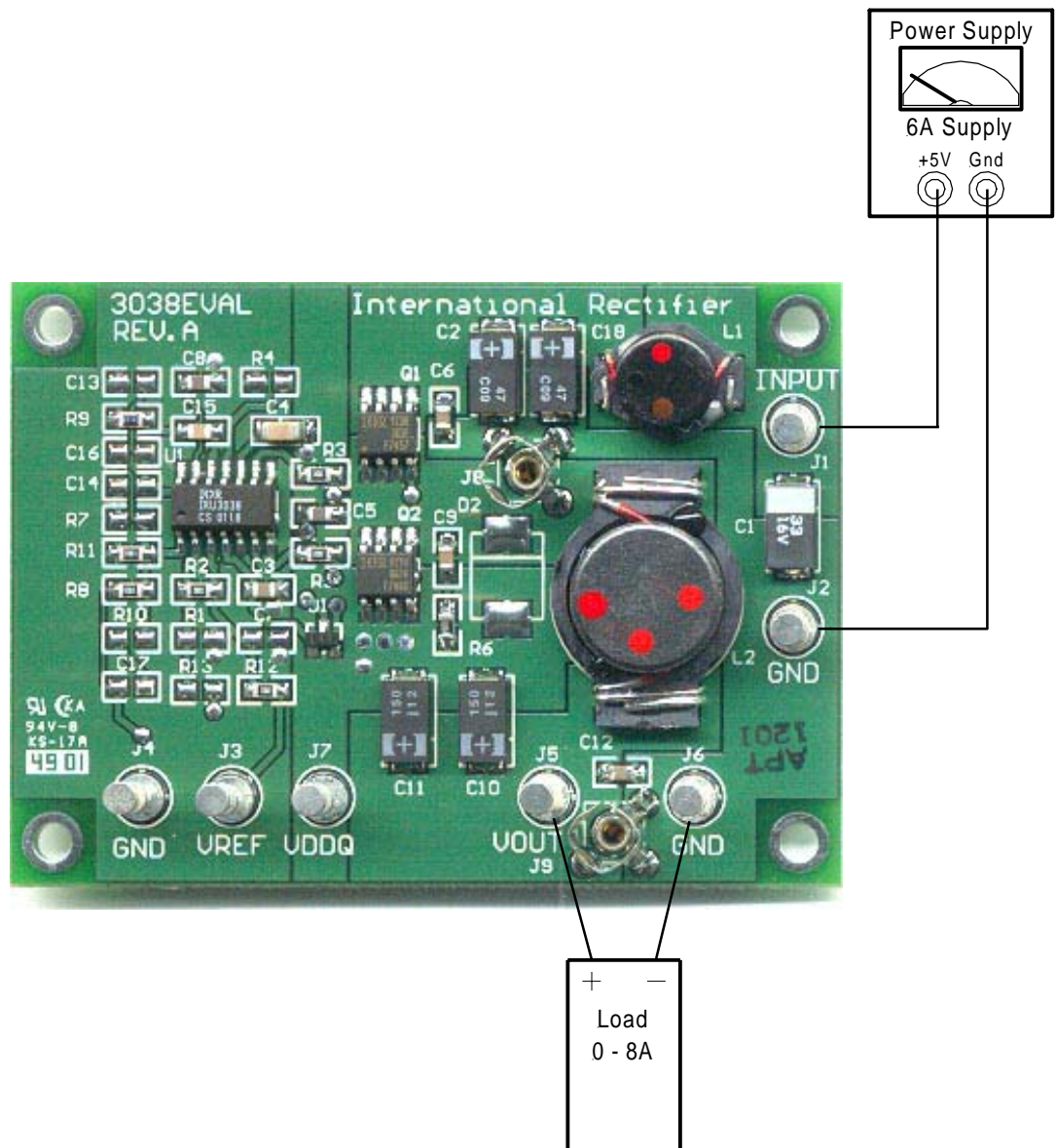

Figure 1 - Connection diagram of evaluation-board for IRU3038.

**LAYOUT**

The top side (component) layer for IRU3038 Eval board is shown in Figure 2. The input capacitors are all located close to the MOSFETs. All the decoupling capacitors, charge pump capacitor and feedback components are located close to IC. The feedback resistors are tied to

the output voltage at the point of regulation.

The PCB is 4-layers board, one layer is dedicated to Power GND and the analog GND is kept separated from the PGND and it is connected at a single point.

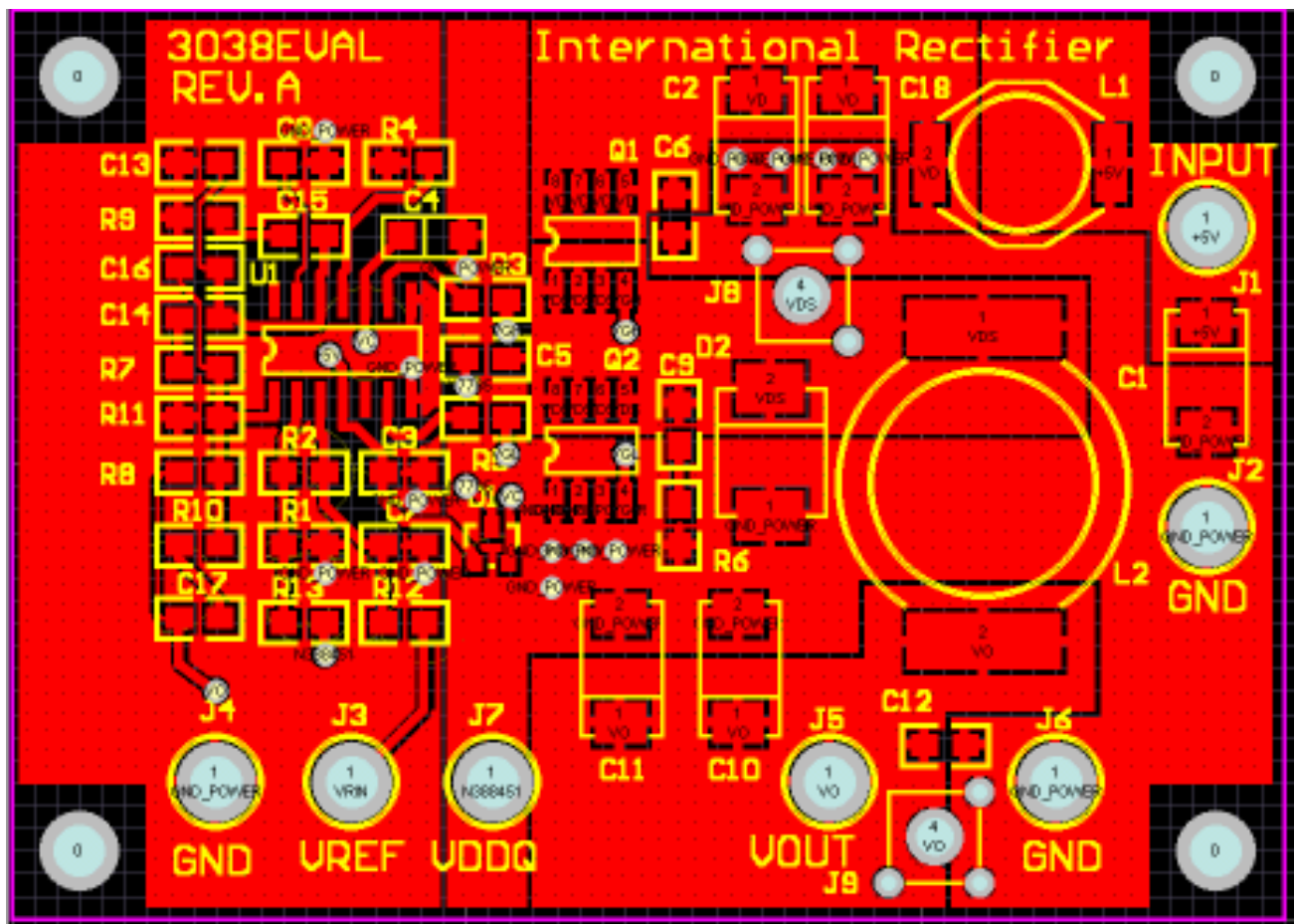

Figure 2 - Top layer of evaluation-board for IRU3038.

**SCHEMATIC**

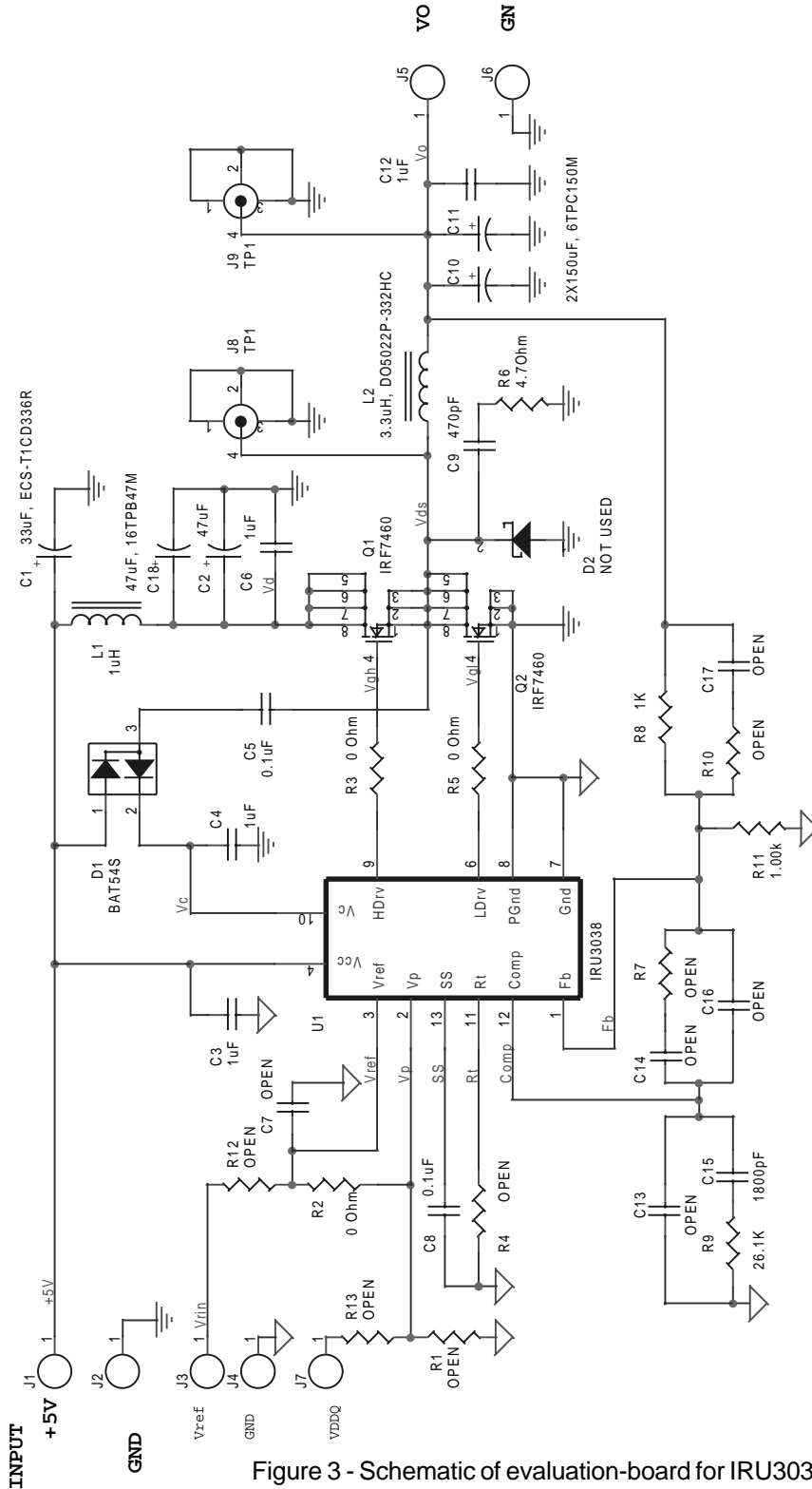

Figure 3 - Schematic of evaluation-board for IRU3038.

Title		IRU3038EVAL
Size	Document Number (Doc)	
A		
Date:	Friday, May 24, 2002	Sheet 1 of 1

**BILL OF MATERIAL**

Ref Desig	Description	Value	Qty	Part#	Manuf	Web site (www.)
Q1, Q2	MOSFET	20V, 10mΩ, 12A	2	IRF7460	IR	irf.com
U1	Controller	Synchronous PWM	1	IRU3038	IR	
D1	Diode	Fast Switching, Schottky	1	BAT54S	IR	
L1	Inductor	1μH, 10A	1	D03316P-102HC	Coilcraft	coilcraft.com
L2	Inductor	3.3μH, 12A	1	D05022P-332HC	Coilcraft	
C1	Cap, Tantalum	33μF, 16V	1	ECS-T1CD336R	Panasonic	maco.panasonic.co.jp
C2,C18	Cap, Poscap	47μF, 16V, 70mΩ	2	16TPB47M	Sanyo	sanyo.com/industrial
C10,C11	Cap, Poscap	150μF, 6.3V, 40mΩ	2	6TPC150M	Sanyo	
C5,C8	Cap, Ceramic	0.1μF, Y5V, 25V	2	ECJ-2VF1E104Z	Panasonic	maco.panasonic.co.jp
C4	Cap, Ceramic	1μF, X7R, 25V	1	ECJ-3YB1E105K	Panasonic	
C15	Cap, Ceramic	1800pF, X7R, 50V	1	ECJ-2VB1H182K	Panasonic	
C9	Cap, Ceramic	470pF, X7R	1	ECJ-2VB2D471K	Panasonic	
C3,C6,C12	Cap, Ceramic	1μF, Y5V, 16V	3	ECJ-2VF1C105Z	Panasonic	
R9	Resistor	26.1K, 5%	1			
R6	Resistor	4.7Ω, 5%	1			
R8,R11	Resistor	1K, 1%	2			
R2,R3,R5	Resistor	0Ω	3			
R1,4,7, 10,12,13	Resistor	Not Used	6			
C7,12,13, 14,16	Capacitor	Not Used	5			
D2	Diode	Not Used	1			

**TEST DATA**

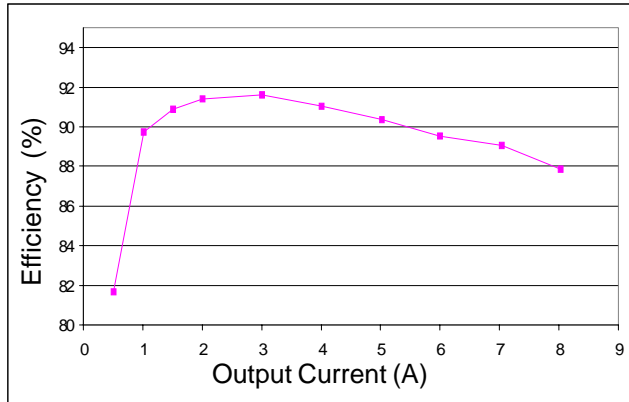

Figure 15 - Efficiency for IRU3038 Evaluation Board.  
 $V_{IN}=5V$ ,  $V_{OUT}=2.5V$

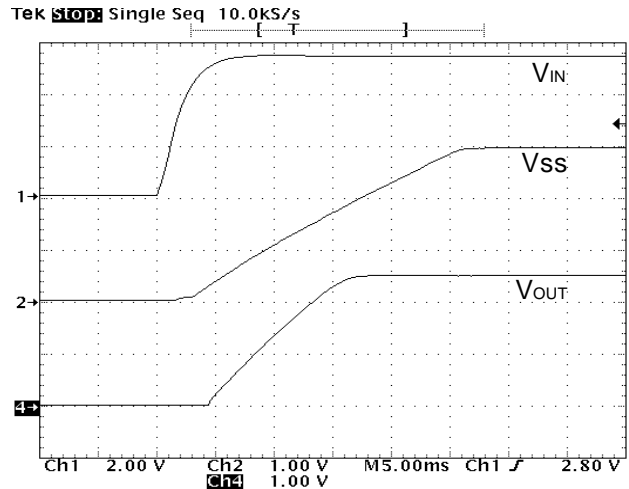

Figure 16 - Start-up time @  $I_{OUT}=5A$ .

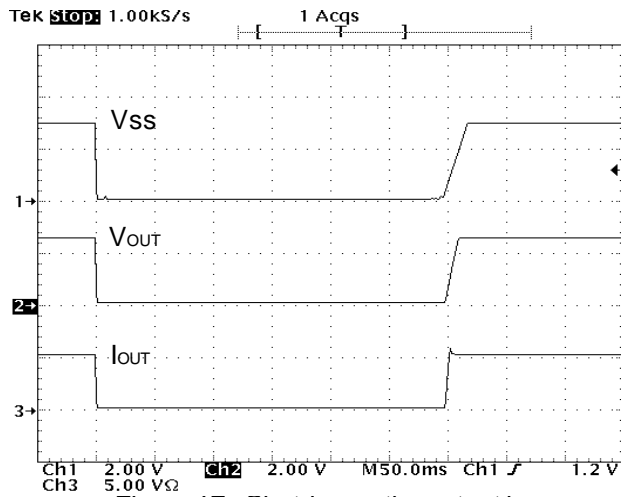

Figure 17 - Shutdown the output by pulling down the soft-start.

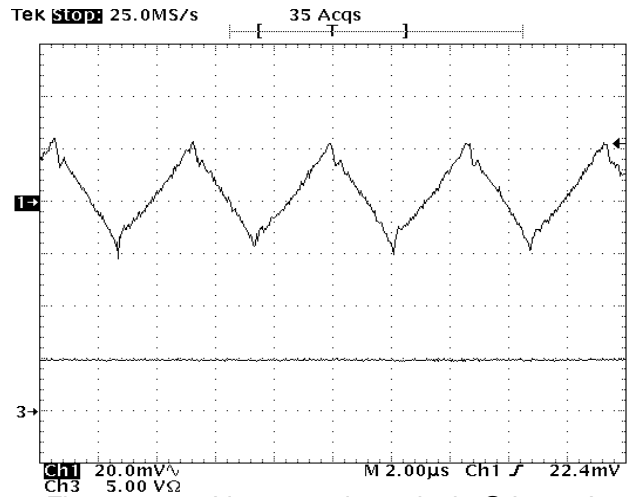

Figure 18 - 3.3V output voltage ripple @  $I_{OUT}=5A$ .

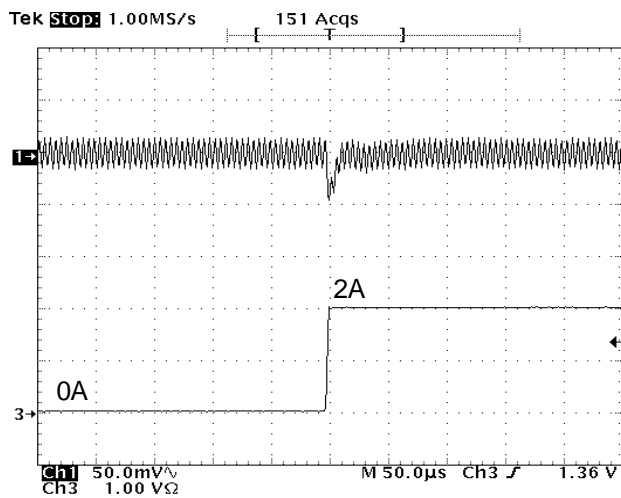

Figure 19 - Transient response @  $I_{OUT}=0$  to 2A.

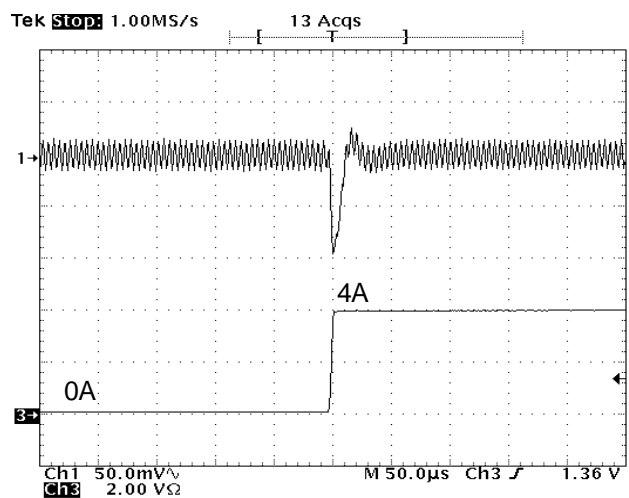

Figure 20 - Transient response @  $I_{OUT}=0$  to 4A.

International  
**IOR** Rectifier

**IR WORLD HEADQUARTERS:** 233 Kansas St., El Segundo, California 90245, USA Tel: (310) 252-7105  
TAC Fax: (310) 252-7903

Visit us at [www.irf.com](http://www.irf.com) for sales contact information

*Data and specifications subject to change without notice. 7/25/2002*