

Salud™ Human Centric Mid Power LED 3030-21C2



Table of Contents

Technology Overview	2
Horticulture Data	2
Product Selection Table	3
Operating Characteristics	6
Chromaticity Diagram	8
Color Ranks	7
Chromaticity Coordinates	7
Characteristics Graphs	9
Ordering Nomenclature	4
Package Dimension	11
Soldering Pad Pattern	11
Dimension and Polarity	11
Reel & Box Packaging	13

Features:

- Engineered spectrum with enhanced cyan for melatonin suppression
- Typical Melanopic/Photopic (M/P) ratios specified
- Enhanced M/P for healthy daytime lighting with warmer CCTs
- Full spectrum emission – no cyan gap
- Excellent color rendering – Ra>90
- No near-UV radiation – safer and better than sunlight

Applications

- | | |
|---------------------|--------------------------|
| • Replacement lamps | • Down lights |
| • Panel lighting | • Architectural lighting |

Technology Overview

Luminus mid power LEDs are lighting class solutions designed for high performance general lighting applications. These state-of-the-art LEDs allow illumination engineers and designers to develop lighting solutions with maximum efficacy, brightness and overall quality.

Reliability

Luminus mid power LED is one of the most reliable light sources in the world today. Having passed a rigorous suite of environmental and mechanical stress tests, including mechanical shock, vibration, temperature cycling and humidity, it is fully qualified for use in a wide range of high performance and high efficacy lighting applications.

REACH & RoHS Compliance

The Luminus 3030 Mid Power LED is compliant to the Restriction of Hazardous Substances Directive or RoHS.

Understanding Luminus Mid Power LED Test Specifications

Every Luminus LED is fully tested to ensure it meets the high quality standards customers have come to expect from Luminus products.

Testing Temperature

Luminus Mid Power products are measured at a case temperature of 25 °C and placed into intensity, chromaticity and voltage bins as described herein

Horticulture Application Data

Standard test condition = 45 mA, T_c=25 °C

Nominal CCT	Minimum CRI	Ordering Part Number	Typical Flux (Lumens)	PPF (μmol/s) 360-830nm	PPF/W (μmol/J) 360-830nm	PPF (μmol/s) 400-700nm	PPF/W (μmol/J) 400-700nm
3000K	90	MP-3030-21C2-30-90	33	0.62	2.59	0.56	2.36
3500K	90	MP-3030-21C2-35-90	36	0.63	2.62	0.58	2.44
4000K	90	MP-3030-21C2-40-90	38	0.63	2.65	0.59	2.49
5000K	90	MP-3030-21C2-50-90	38	0.64	2.70	0.61	2.55

Product Selection Table

Standard test condition = 45 mA, T_c=25 °C

Nominal CCT	Minimum CRI	Ordering Part Number	Minimum Flux (Lumens)	Typical Flux (Lumens)	Min R9	Typ R9	Typ. Melanopic Ratio (MR)
3000K	90	MP-3030-21C2-30-90	30	33	85	95	0.68
3500K	90	MP-3030-21C2-35-90	34	36	65	75	0.72
4000K	90	MP-3030-21C2-40-90	36	38	55	65	0.80
5000K	90	MP-3030-21C2-50-90	36	38	70	80	0.96

*Tolerance of measurements of the luminous flux is ±7%

* Tolerance of measurements of the CRI is ±2

*IFP condition with Pulse: Width ≤100µs Duty cycle ≤1/10

Salud Line of 3030 Midpower Products

At Luminus, we have also leveraged our expertise in creating special LED spectrums to develop the Salud line of 3030 midpower products. These energizing, productivity-enhancing, attractive LED light sources are rich in cyan content while maintaining warm CCTs which lighting designers prefer, such as 3000K, 3500K, 4000K, and 5000K. At the same time, the Salud line also has saturated 660nm red spectral content and 90 CRI minimum, which means we render beautiful colors and skin tones while we also keep you healthy. All of this is done without any of the harmful UV which you would find in sunlight. While other LEDs might promise you a spectrum similar to sunlight (including a bit of UV – beware!), Salud offers a broad spectrum with a high MR for safe, healthy daytime lighting applications. Some of the metrics used in HCL include circadian stimulus (CS) and melanopic ratio (MR), also commonly known as melanopic/ photopic (M/P), not to be confused with the “other” M/P, mesopic/photopic.

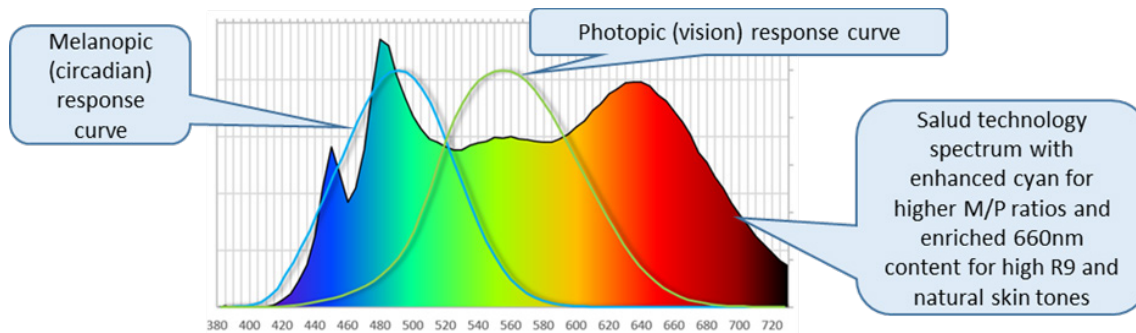

- The Melanopic/Photopic ratio (a.k.a. M/P ratio, MP ratio, or “MR”) is a metric to quantify lighting’s circadian effect

$$MR = K \frac{\int_{380}^{780} C(\lambda)P(\lambda)d\lambda}{\int_{380}^{780} V(\lambda)P(\lambda)d\lambda}$$

- P(λ) is spectral power distribution of the light source
- C(λ) is the circadian action function (melanopic response curve)
- V(λ) is the eye sensitivity function (visual or photopic response curve)
- The higher MR ratio, the stronger the circadian effect of the light source

Product Ordering and Shipping Part Number Nomenclature

All mid power products are packaged and labeled with part numbers as outlined in below. When shipped, each reel will contain only a single flux and voltage bin. The part number designation is as follows:

3030 Mid Power LEDs

Mid Power	Package Type	Package Configurator	Nominal CCT	Minimum CRI
MP	3030	21C2	##	##

Example:

The part number MP-3030-21C2-30-80 refers to a 3030 mid power emitter with nominal color temperature of 3,000k and minimum CRI of 80. Please refer to page 5 for a description of available CCT and CRI combinations.

Note 1: CCT Codes:

30= 3000 k

35= 3500 k

40= 4000 k

50= 5000 k

Note 2: CRI Codes:

90

Each mid power product shipped will be labeled with its specific flux and voltage bins. Not all bins listed are available in all CCTs and CRIs.

Test condition = 45 mA, $T_c=25^\circ\text{C}$

Forward Voltage Bins ($T_c=25^\circ\text{C}$)

Bin Code	Minimum Voltage (Volts)	Maximum Voltage (Volts)
X3	5.2	5.4
Y3	5.4	5.6

Luminus Flux Bins

Bin Code	Minimum Flux (Lumens)	Maximum Flux (Lumens)
D8	30	32
D9	32	34
E1	34	36
E2	36	38
E3	38	42

Tolerance of measurements of forward voltage is $\pm 0.1V$

3030 Mid Power Operating Characteristics

Optical and Electrical Characteristics ($T_c=25^\circ\text{C}$)

Parameter	Symbol	Minimum	Typical	Maximum	Unit	Condition
Forward Voltage	V_f	5.2	5.3	5.6	V	$I_f=45\text{mA}$
Reverse Current	I_r			2	μA	$V_r=5\text{V}$
View Angle	$2\theta^{1/2}$		120		$^\circ$	$I_f=45\text{mA}$
Thermal Resistance	R_{th}_{j-sp}		23		$^\circ\text{C/W}$	$I_f=45\text{mA}$
Electrostatic Discharge	ESD	1000			V	

Note 1: To prevent damage refer to operating conditions and derating curves for appropriate maximum operating conditions

Note 2: Maximum operating case temperature combined with maximum drive current defines the total maximum operating condition for the device. To prevent damage, please follow derating curves for all operating conditions.

Note 3: Mid power LEDs are designed for operation up to an absolute maximum forward drive current as specified above. Product lifetime data is specified at typical forward drive currents. Sustained operation at absolute maximum currents will result in a reduction of device lifetime compared to typical forward drive currents. Actual device lifetimes will also depend on case temperature. Refer to the current vs. case temperature derating curves for further information.

Note 4: Caution must be taken not to stare at the light emitted from these LEDs. Under special circumstances, the high intensity could damage the eye.

Absolute Maximum Ratings ($T_c=25^\circ\text{C}$)

Parameter	Symbol	Rating	Unit
Forward Current	I_f	120	mA
Pulse Forward Current	I_{fp}	200	mA
Power Dissipation	P_d	0.8	W
Reverse Voltage	V_r	5	V
Operating Temperature	T_{opr}	-40~+85	$^\circ\text{C}$
Storage Temperature	T_{sta}	-40~+100	$^\circ\text{C}$
Junction Temperature	T_j	135	$^\circ\text{C}$
Soldering Temperature	T_{sld}	230 $^\circ\text{C}$ or 260 $^\circ\text{C}$ for 10 sec	

*IFP condition with Pulse: Width $\leq 100\mu\text{s}$ Duty cycle $\leq 1/10$

Color Bins

Color Code	Step	Center (Tc=25 °C)		Radius		Angle(deg)
		x	y	a	b	θ
3000	3	0.4342	0.4028	0.008340	0.00408	53.13
	5			0.013900	0.00680	
3500	3	0.4080	0.3916	0.009270	0.00414	54.00
	5			0.015450	0.00690	
4000	3	0.3825	0.3798	0.009390	0.00402	53.43
	5			0.015650	0.00670	
5000	3	0.3451	0.3554	0.008220	0.00354	59.37
	5			0.013700	0.00590	

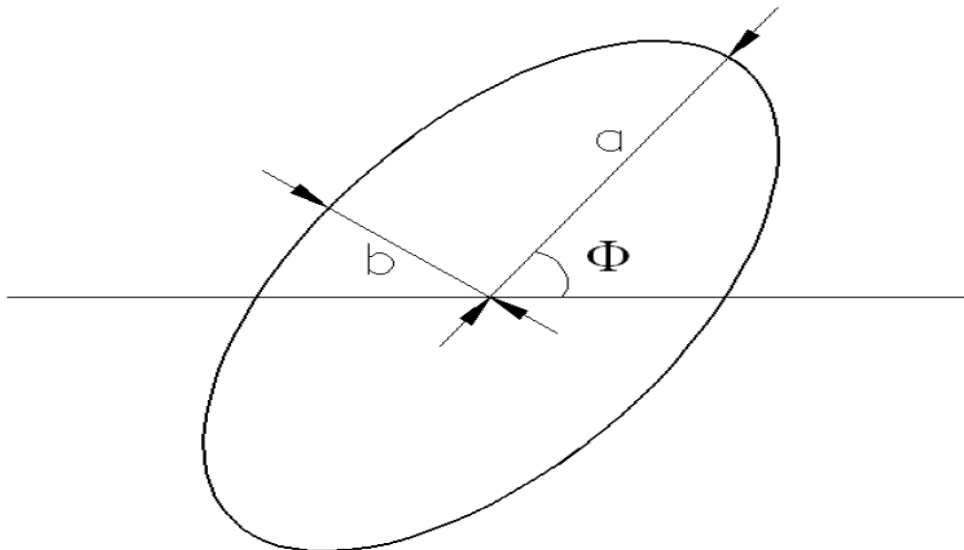
Ellipse Definition

*Note: Tolerance of measurements of the chromaticity Coordinate is ± 0.005
 Chromaticity coordinates as per ANSI standard.

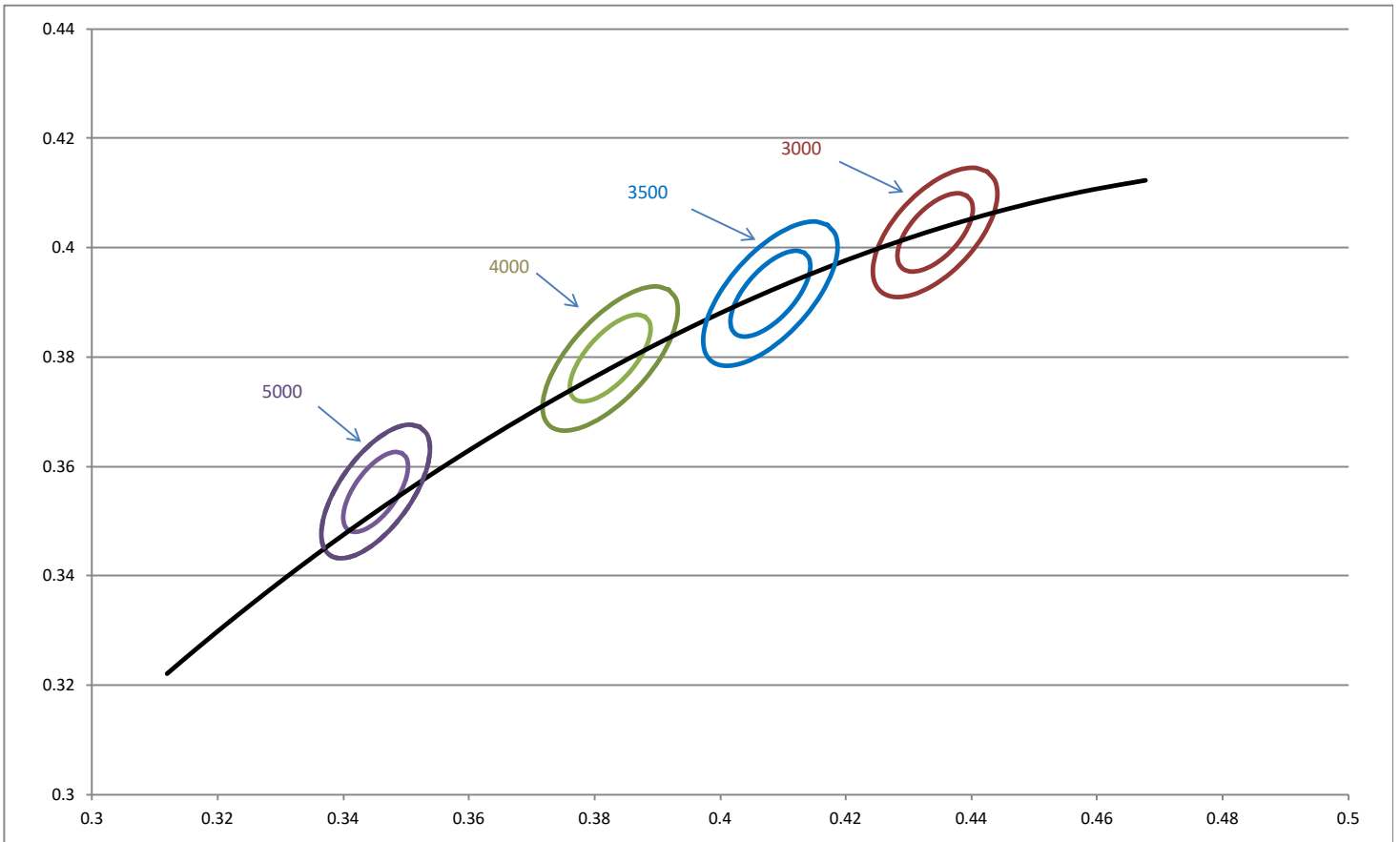
Chromaticity Coordinate Group

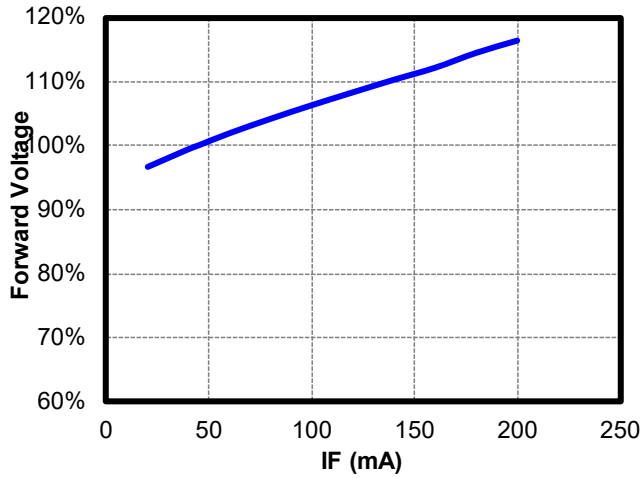
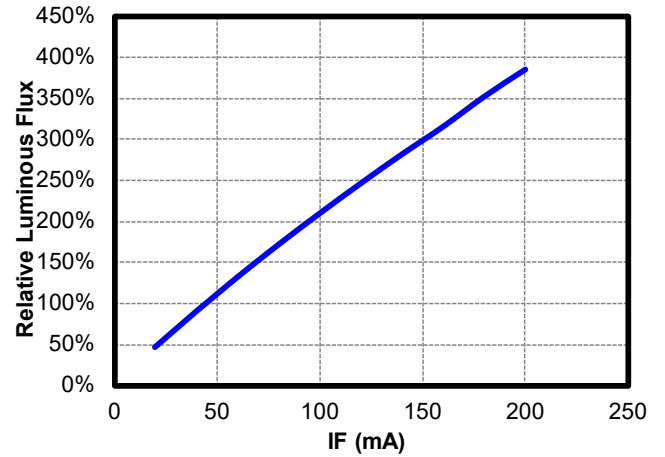
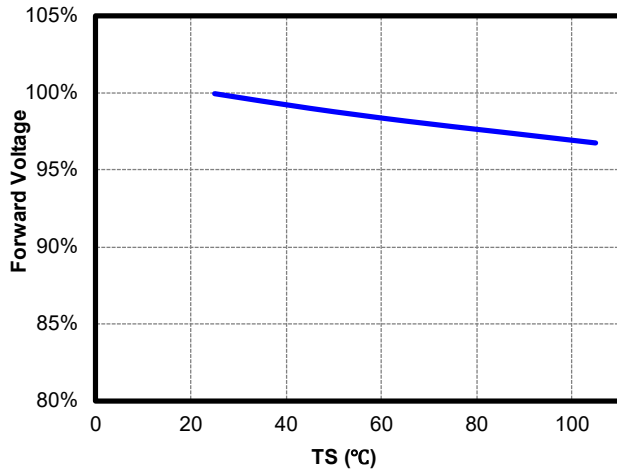
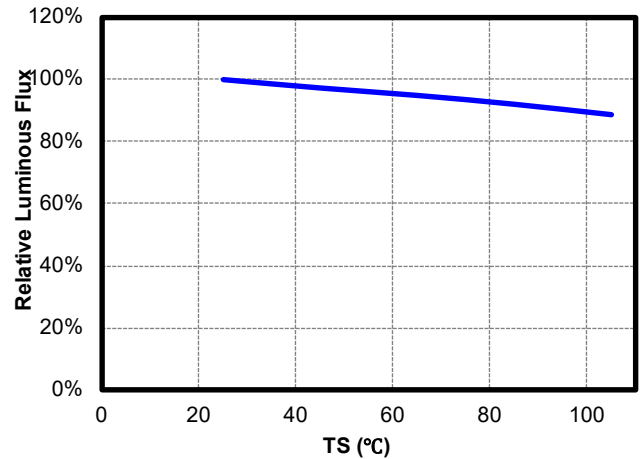
Typical optical/Electrical Characteristics Graphs
Forward Current vs. Forward Voltage

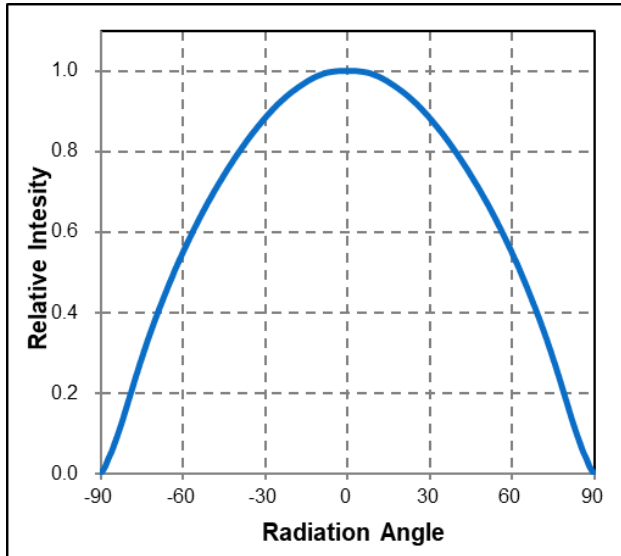
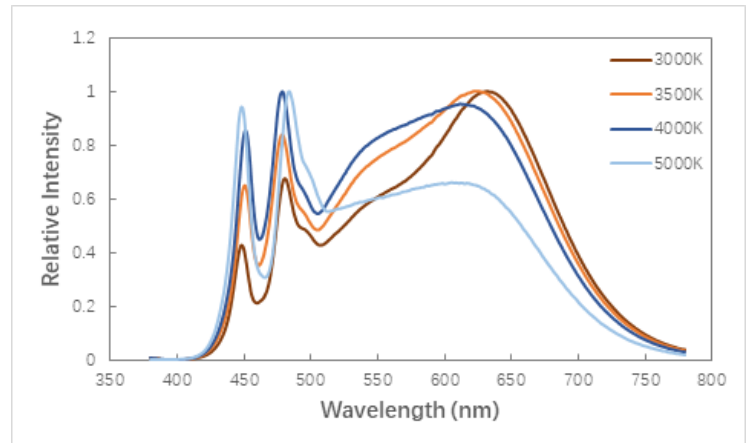
Forward Current vs. Relative Intensity

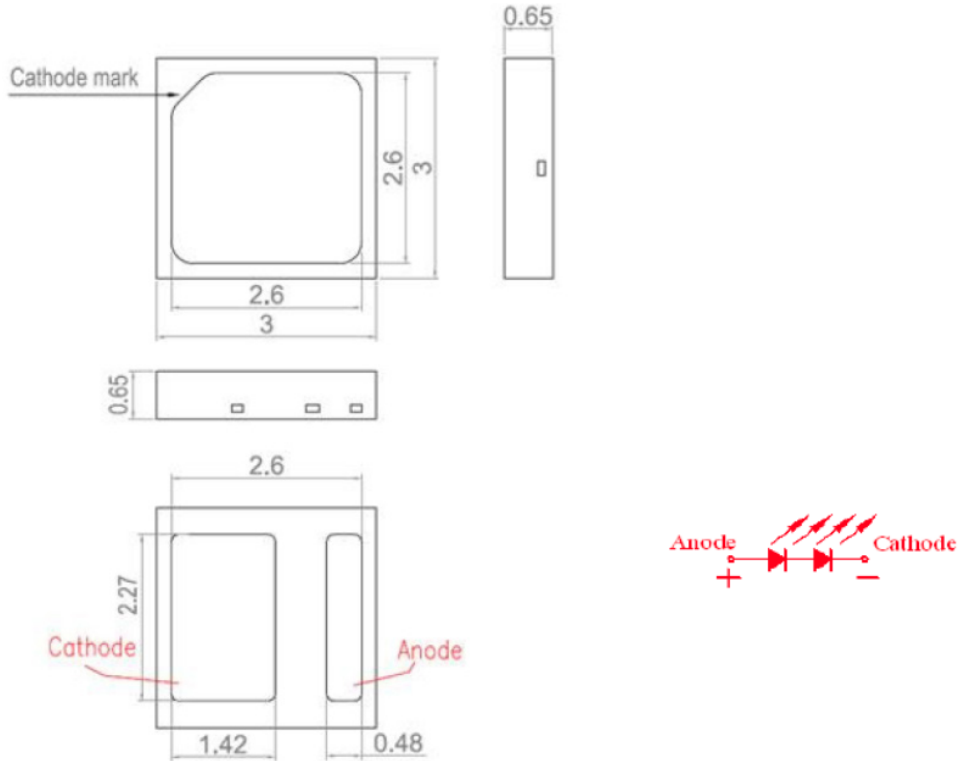
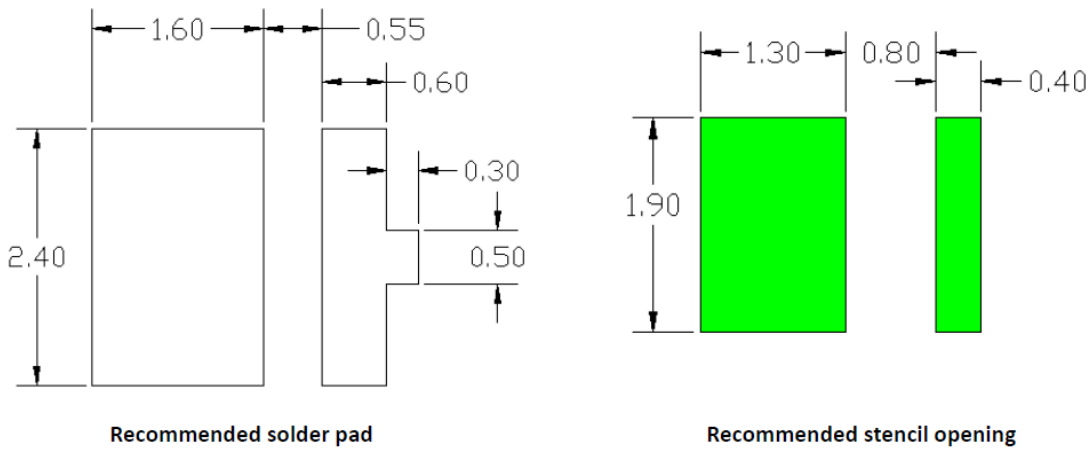
Ambient Temperature vs. Relative Forward Voltage

Ambient Temperature vs. Relative Intensity

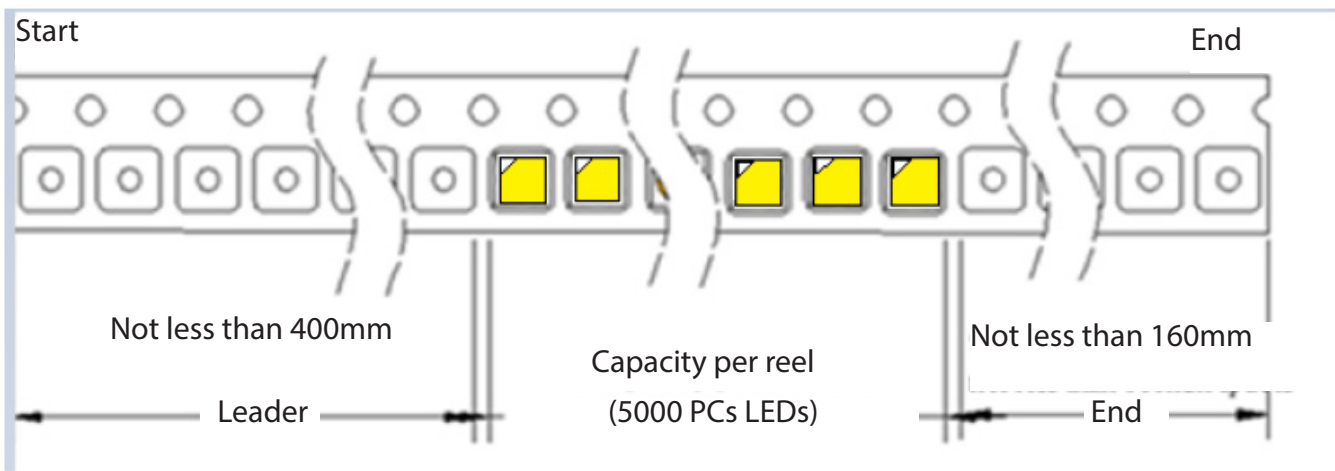
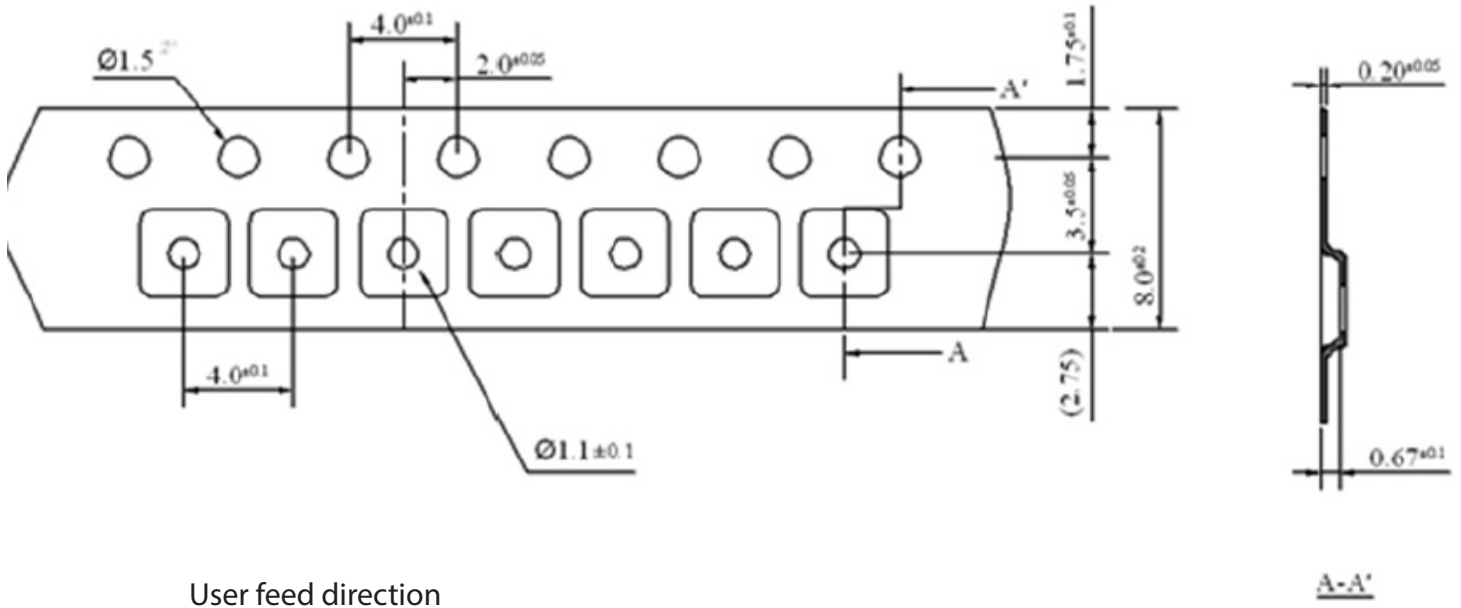
Typical Optical/Electrical Characteristic
Typical Polar Radiation Pattern

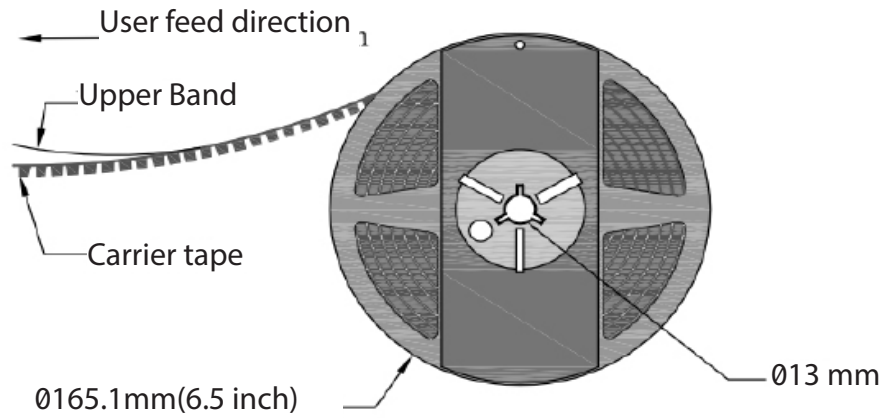
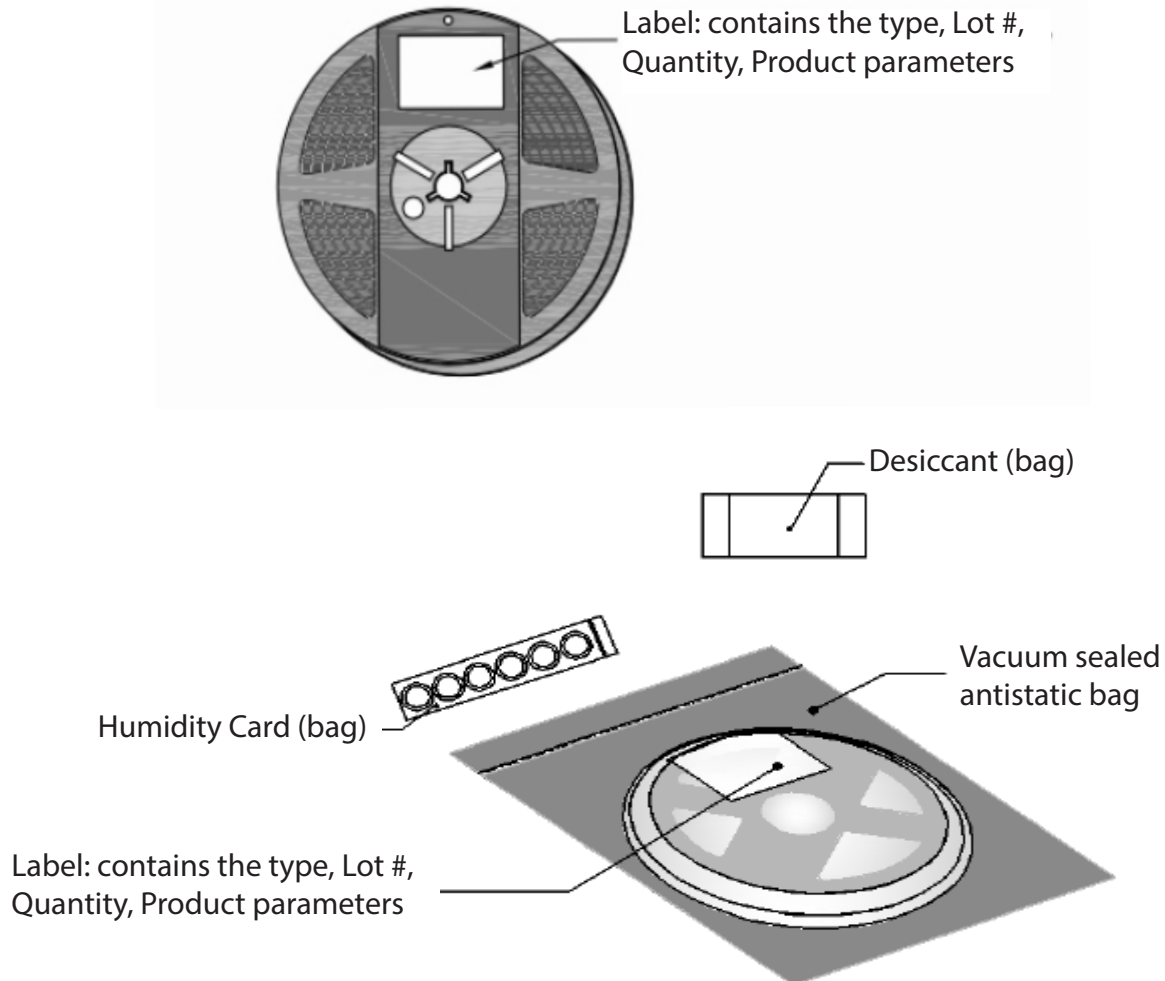
Spectrum Distribution

Package Dimension (mm)

Recommended Soldering Pad Pattern

Recommended solder pad
Recommended stencil opening

Note: tolerance : .X: $\pm 0.10\text{mm}$.XX: $\pm 0.05\text{mm}$

Package Dimensions Of Tape(mm)

Package Dimensions of Reel (mm)

Package Dimensions of Reel (mm)

Box Packaging

*Capacity 5 reels per box



Label: contains the type,
Lot #, Quantity, Product
parameters



*Capacity 10 packages per box



Label: contains the type,
Lot #, Quantity, Product
parameters

Precaution for Use

Storage:

1. This device is rated at MSL 3 per JEDEC J-STD-020 standard.
2. Recommended storage condition:
At 5 °C- 30 °C and relative humidity 60% RH in its original package
3. After this bag is opened, devices that will be applied to infrared reflow, vapor - phase reflow, or equivalent soldering process must be:
 - a) Completed within 168 hours
 - b) Stored at less than 60%RH
 - c) If not completely used within 168 hours, seal the remaining in the moisture barrier bag
4. Devices require baking before mounting, if 3 a) is not met.
5. If baking is required, devices must be baked under below conditions:
24 hours at 60 °C +/- 5 °C

Static Electricity:

1. The products are sensitive to static electricity, and care should be taken when handling them.
2. Static electricity or surge voltage will damage the LEDs. It is recommended to wear a anti-electrostatic wristband or an anti-electrostatic gloves when handling the LEDs.
3. All devices, equipment and machinery must be properly grounded. It is recommended that measures be taken against surge voltage to the equipment that mounts the LEDs.