

EPC2088 – Enhancement Mode Power Transistor

 $V_{DS}, 100\text{ V}$
 $R_{DS(on)}, 3.2\text{ m}\Omega\text{ max}$
 $I_D, 60\text{ A}$

RoHS



Halogen-Free

Gallium Nitride's exceptionally high electron mobility and low temperature coefficient allows very low $R_{DS(on)}$, while its lateral device structure and majority carrier diode provide exceptionally low Q_G and zero Q_{RR} . The end result is a device that can handle tasks where very high switching frequency, and low on-time are beneficial as well as those where on-state losses dominate.

Application Notes:

- Easy-to-use and reliable gate
- Gate Drive ON = 5–5.25 V typical, OFF = 0 V (negative voltage not needed)
- Recommended dead time (half bridge circuit) $\leq 30\text{ ns}$ for best efficiency
- Top of FET (back side) is electrically connected to source

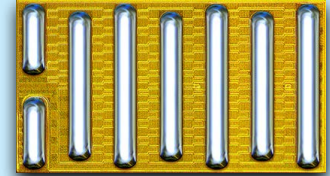

Die Size: 3.5 x 1.95 mm

EPC2088 eGaN® FETs are supplied only in passivated die form with solder bars.

Applications

- DC-DC Converters
- BLDC Motor Drives
- Sync Rectification for AC/DC and DC-DC
- Point-of-Load Converters
- USB-C
- Lidar
- Class-D Audio
- LED Lighting
- E-Mobility

Benefits

- Ultra High Efficiency
- No Reverse Recovery
- Ultra Low Q_G
- Small Footprint

Maximum Ratings			
PARAMETER		VALUE	UNIT
V_{DS}	Drain-to-Source Voltage (Continuous)	100	V
	Drain-to-Source Voltage (up to 10,000 5 ms pulses at 150 °C)	120	
I_D	Continuous ($T_A = 25^\circ\text{C}$)	60	A
	Pulsed ($25^\circ\text{C}, T_{PULSE} = 300\ \mu\text{s}$)	231	
V_{GS}	Gate-to-Source Voltage	6	V
	Gate-to-Source Voltage	-4	
T_J	Operating Temperature	-40 to 150	°C
T_{STG}	Storage Temperature	-40 to 150	

Thermal Characteristics			
PARAMETER		TYP	UNIT
$R_{\theta JC}$	Thermal Resistance, Junction-to-Case	0.5	°C/W
$R_{\theta JB}$	Thermal Resistance, Junction-to-Board	1.4	
$R_{\theta JA}$	Thermal Resistance, Junction-to-Ambient (Note 1)	53	

Note 1: $R_{\theta JA}$ is determined with the device mounted on one square inch of copper pad, single layer 2 oz copper on FR4 board. See https://epc-co.com/epc/documents/product-training/Appnote_Thermal_Performance_of_eGaN_FETs.pdf for details.

Static Characteristics ($T_J = 25^\circ\text{C}$ unless otherwise stated)						
PARAMETER		TEST CONDITIONS	MIN	TYP	MAX	UNIT
BV_{DSS}	Drain-to-Source Voltage	$V_{GS} = 0\text{ V}, I_D = 0.1\text{ mA}$	100			V
I_{DSS}	Drain-Source Leakage	$V_{GS} = 0\text{ V}, V_{DS} = 80\text{ V}$		0.002	0.08	mA
I_{GSS}	Gate-to-Source Forward Leakage	$V_{GS} = 5\text{ V}$		0.007	2.3	
	Gate-to-Source Forward Leakage [#]	$V_{GS} = 5\text{ V}, T_J = 125^\circ\text{C}$		1	9	
	Gate-to-Source Reverse Leakage	$V_{GS} = -4\text{ V}$		0.01	0.2	
$V_{GS(TH)}$	Gate Threshold Voltage	$V_{DS} = V_{GS}, I_D = 7\text{ mA}$	0.7	1.3	2.5	V
$R_{DS(on)}$	Drain-Source On Resistance	$V_{GS} = 5\text{ V}, I_D = 25\text{ A}$		2.4	3.2	mΩ
V_{SD}	Source-Drain Forward Voltage [#]	$I_S = 0.5\text{ A}, V_{GS} = 0\text{ V}$		1.5		V

[#] Defined by design. Not subject to production test.

Scan QR code or click link below for more information including reliability reports, device models, demo boards!



<https://l.ead.me/EPC2088>

Dynamic Characteristics[#] (T_j = 25°C unless otherwise stated)

PARAMETER		TEST CONDITIONS	MIN	TYP	MAX	UNIT
C _{ISS}	Input Capacitance	V _{DS} = 50 V, V _{GS} = 0 V		1864	2703	pF
C _{RSS}	Reverse Transfer Capacitance			3.6		
C _{OSS}	Output Capacitance			557	659	
C _{OSS(ER)}	Effective Output Capacitance, Energy Related (Note 2)	V _{DS} = 0 to 50 V, V _{GS} = 0 V		694		
C _{OSS(TR)}	Effective Output Capacitance, Time Related (Note 3)			944		
R _G	Gate Resistance			0.4		Ω
Q _G	Total Gate Charge	V _{DS} = 50 V, V _{GS} = 5 V, I _D = 25 A		12.5	17.8	nC
Q _{GS}	Gate-to-Source Charge	V _{DS} = 50 V, I _D = 25 A		4.4		
Q _{GD}	Gate-to-Drain Charge			1.4		
Q _{G(TH)}	Gate Charge at Threshold			3.2		
Q _{OSS}	Output Charge	V _{DS} = 50 V, V _{GS} = 0 V		47	55	
Q _{RR}	Source-Drain Recovery Charge			0		

Defined by design. Not subject to production test.

All measurements were done with substrate connected to source.

Note 2: C_{OSS(ER)} is a fixed capacitance that gives the same stored energy as C_{OSS} while V_{DS} is rising from 0 to 50% BV_{DSS}.

Note 3: C_{OSS(TR)} is a fixed capacitance that gives the same charging time as C_{OSS} while V_{DS} is rising from 0 to 50% BV_{DSS}.

Figure 1: Typical Output Characteristics at 25°C

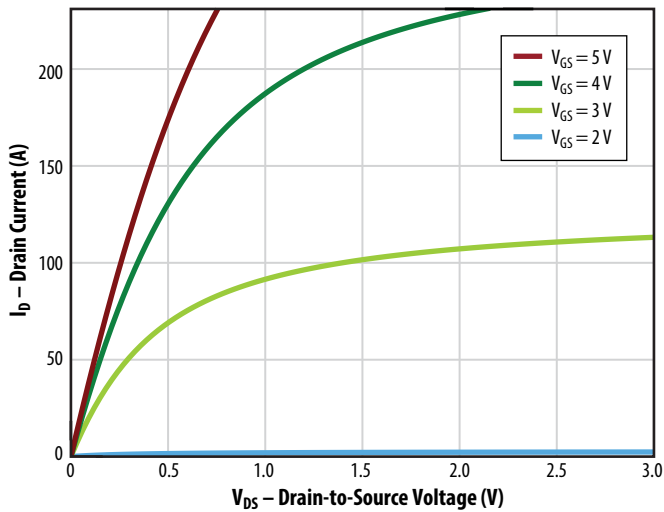

Figure 2: Typical Transfer Characteristics

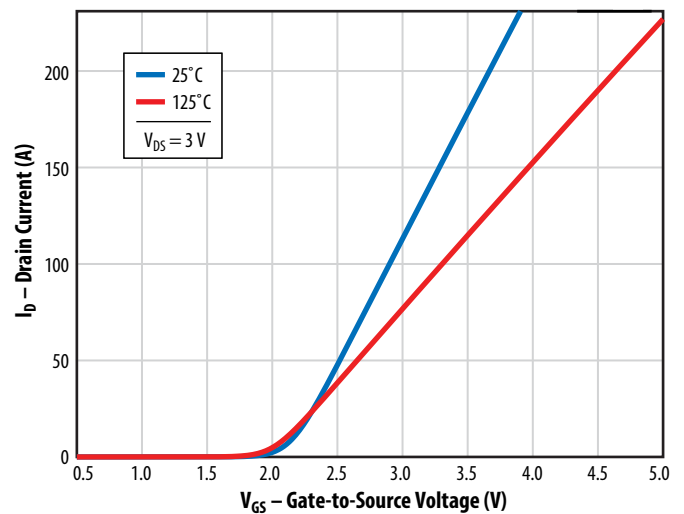

Figure 3: R_{DS(on)} vs. V_{GS} for Various Drain Currents

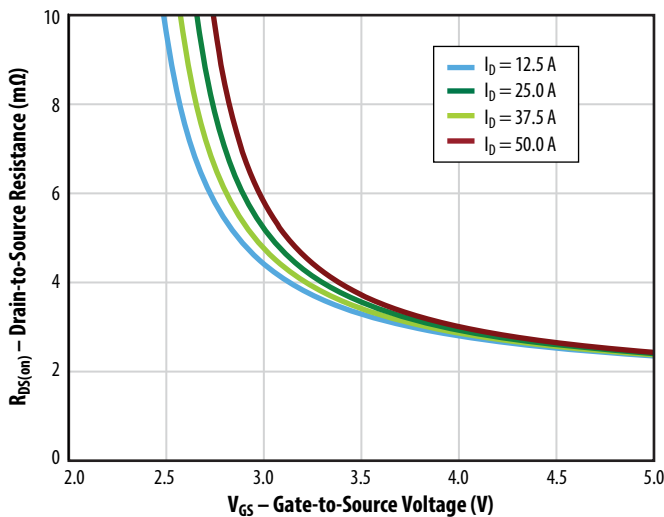

Figure 4: R_{DS(on)} vs. V_{GS} for Various Temperatures

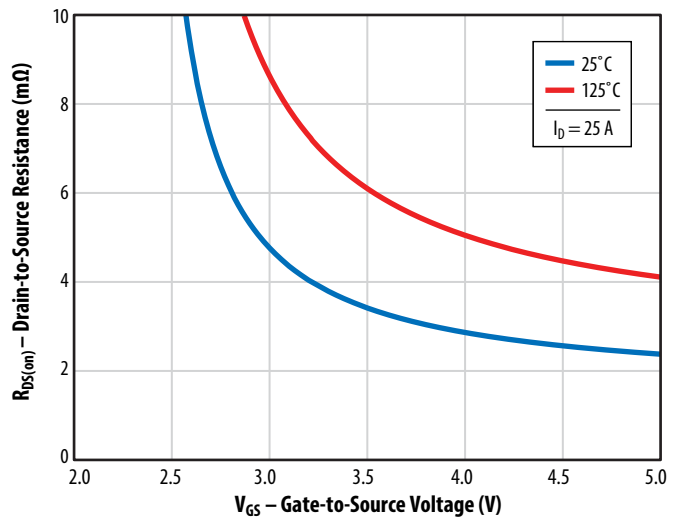

Figure 5a: Typical Capacitance (Linear Scale)

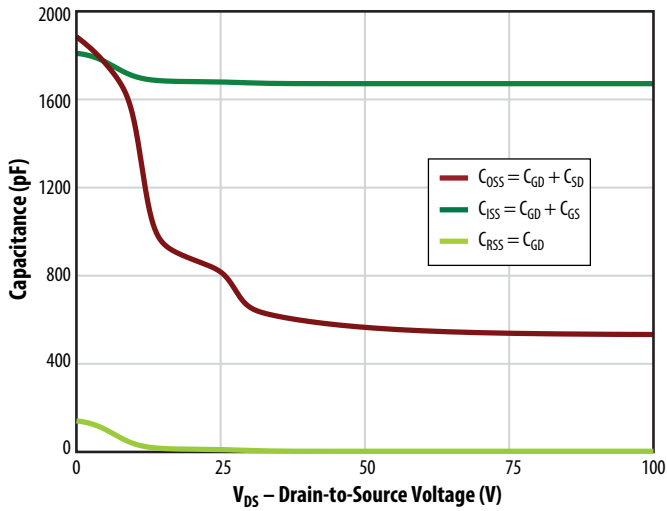

Figure 5b: Typical Capacitance (Log Scale)

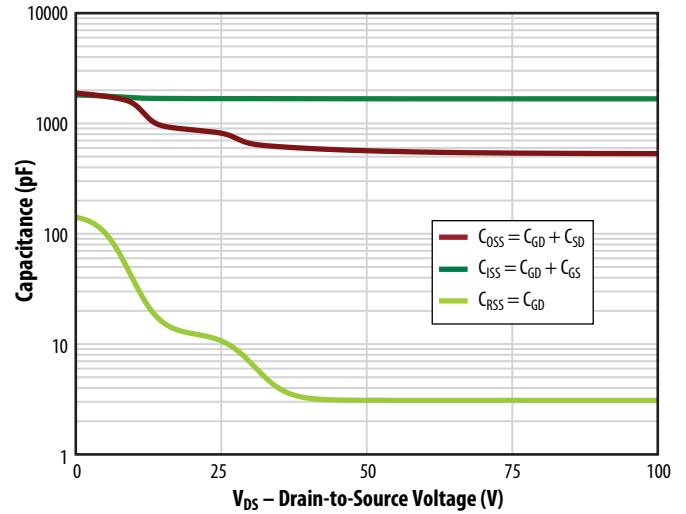

Figure 6: Typical Output Charge and C_OSS Stored Energy

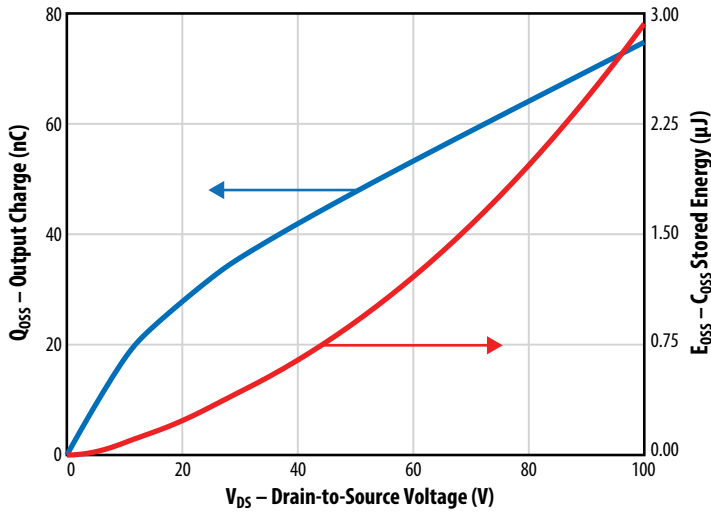

Figure 7: Typical Gate Charge

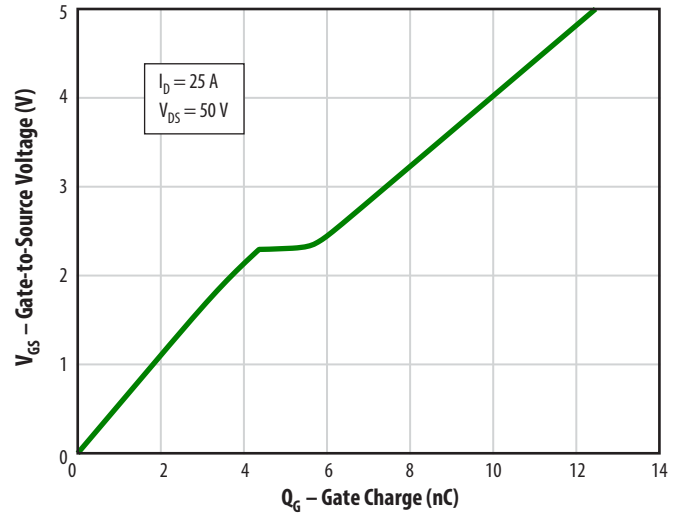

Figure 8: Reverse Drain-Source Characteristics

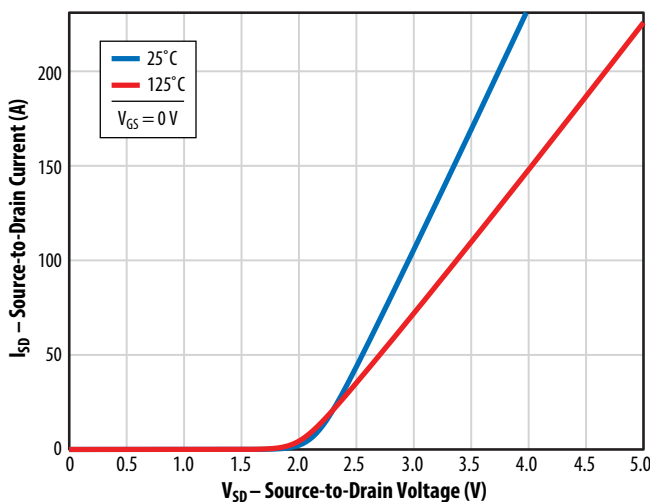
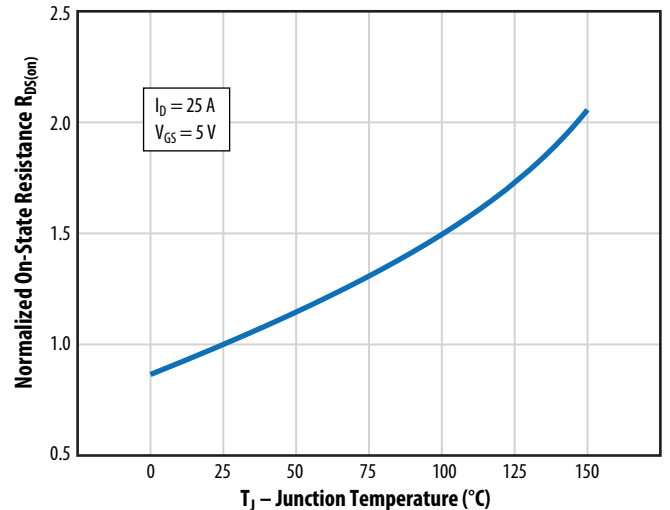

Figure 9: Normalized On-State Resistance vs. Temperature



Note: Negative gate drive voltage increases the reverse drain-source voltage. EPC recommends 0 V for OFF.

Figure 10: Normalized Threshold Voltage vs. Temperature

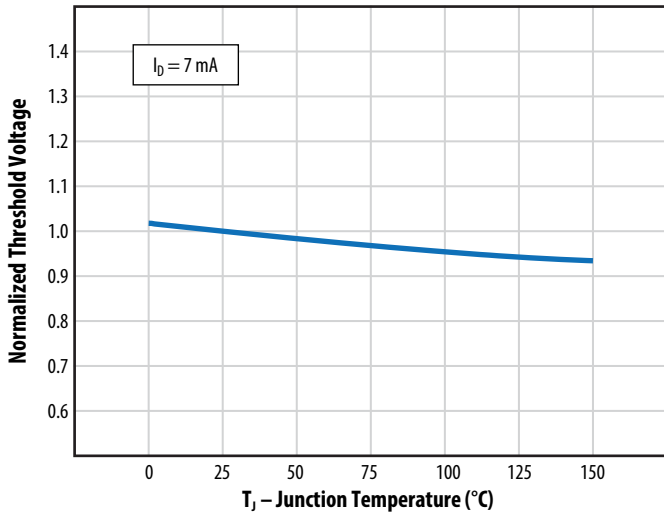

Figure 11: Safe Operating Area

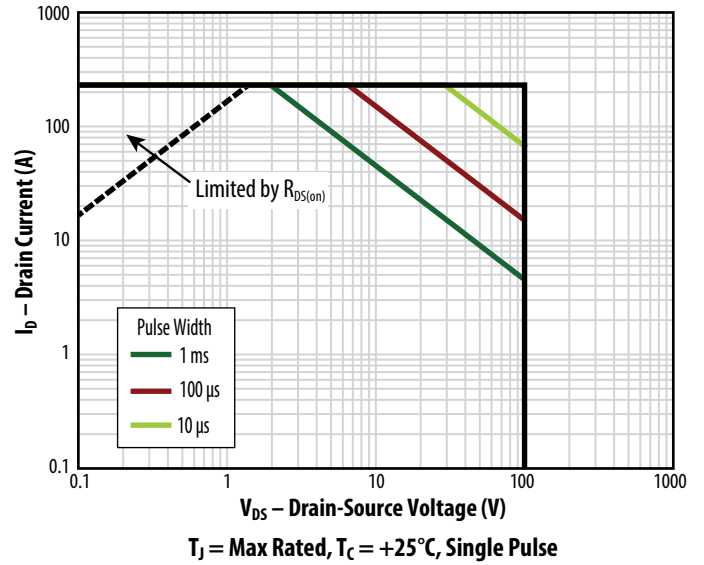
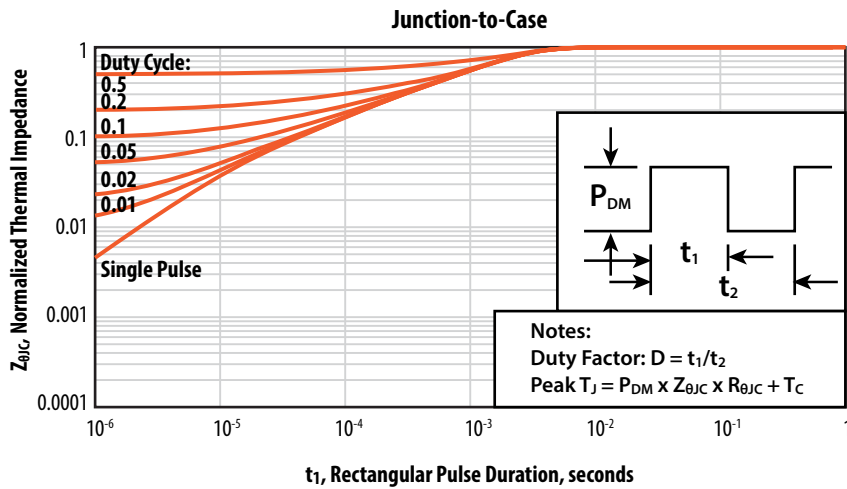
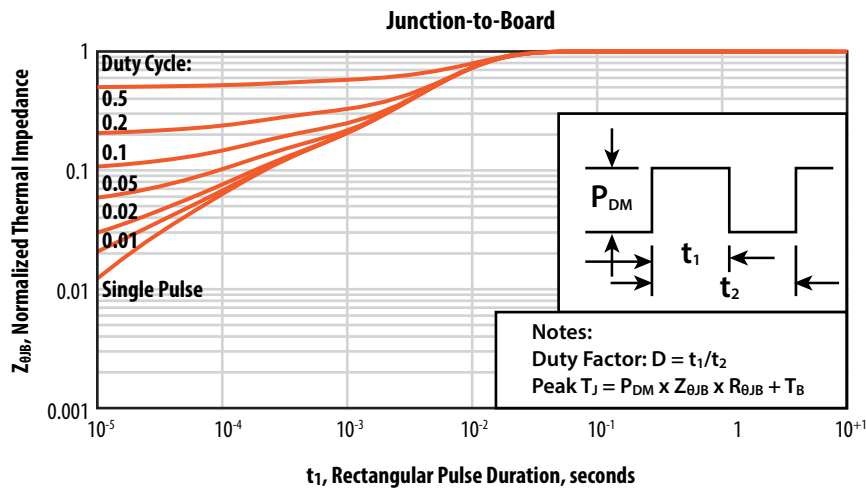

Figure 12: Transient Thermal Response Curves



LAYOUT CONSIDERATIONS

GaN transistors generally behave like power MOSFETs, but at much higher switching speeds and power densities, therefore layout considerations are very important, and care must be taken to minimize layout parasitic inductances. The recommended design utilizes the first inner layer as a power loop return path. This return path is located directly beneath the top layer's power loop allowing for the smallest physical loop size. This method is also commonly referred to as flux cancellation. Variations of this concept can be implemented by placing the bus capacitors either next to the high side device, or next to the low side device, or between the low and high side devices, but in all cases the loop is closed using the first inner layer right beneath the devices.

A similar concept is also used for the gate loop, with the return gate loop located directly under the turn ON and OFF gate resistors.

Furthermore, to minimize the common source inductance between power and gate loops, the power and gate loops are laid out perpendicular to each other, and a via next to the source pad closest to the gate pad is used as Kelvin connection for the gate driver return path.

The [EPC90154 Quick Start Guide – 100 V, 40 A Half-Bridge Development Board Using EPC2088](#) implements our recommended vertical inner layout.

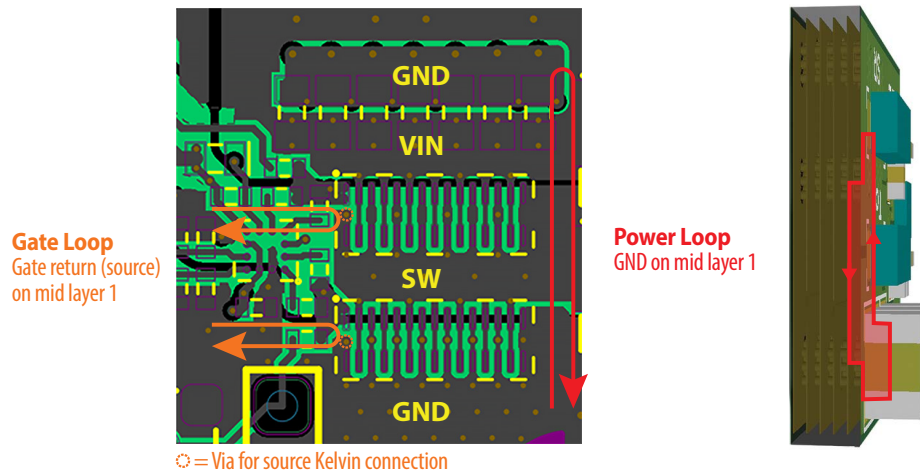

Figure 13: Inner vertical layout for power and gate loops from EPC90154

Detailed recommendations on layout can be found on EPC's website: [Optimizing PCB Layout with eGaN FETs.pdf](#)

TYPICAL SWITCHING BEHAVIOR

The following typical switching waveforms are captured in these conditions:

- [EPC90154 – 100 V, 40 A Half-bridge Development Board using EPC2088](#)
- Gate driver: uP1966E with 0.4 Ω /0.7 Ω pull-down/pull-up resistance
- External $R_G(\text{ON}) = 1 \Omega$, $R_G(\text{OFF}) = 0 \Omega$
- $V_{\text{IN}} = 48 \text{ V}$, $I_L = 25 \text{ A}$

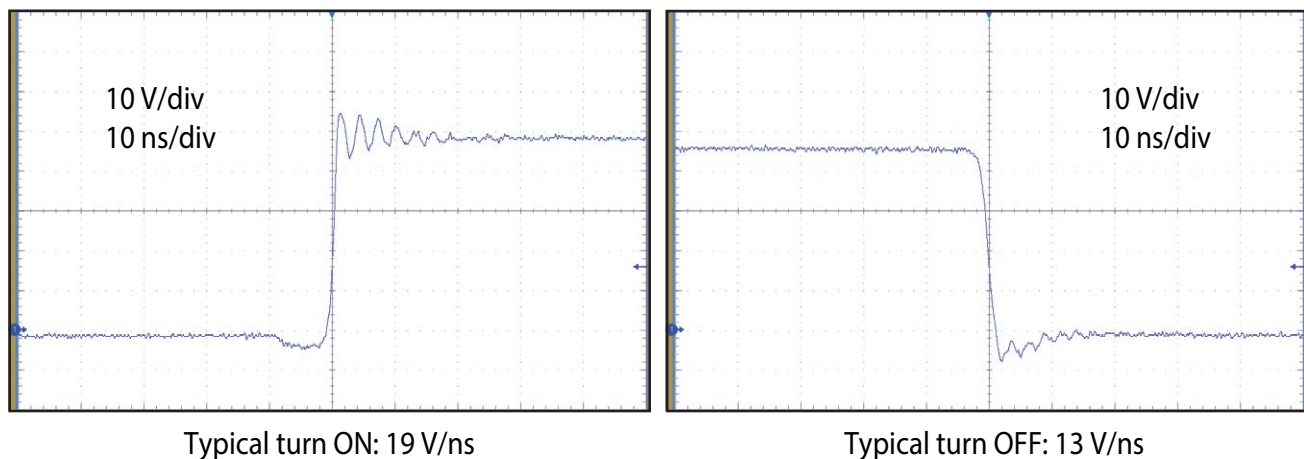

Figure 14: Typical half-bridge voltage switching waveforms

See the [EPC90154 Quick Start Guide \(QSG\)](#) for more information.

TYPICAL THERMAL CONCEPT

The EPC2088 can take advantage of dual sided cooling to maximize its heat dissipation capabilities in high power density designs. **Note that the top of EPC FETs are connected to source potential, so for half-bridge topologies the Thermal Interface Material (TIM) needs to provide electrical isolation to the heatsink.**

Recommended best practice thermal solutions are covered in detail in [How2AppNote012 - How to Get More Power Out of an eGaN Converter.pdf](#).

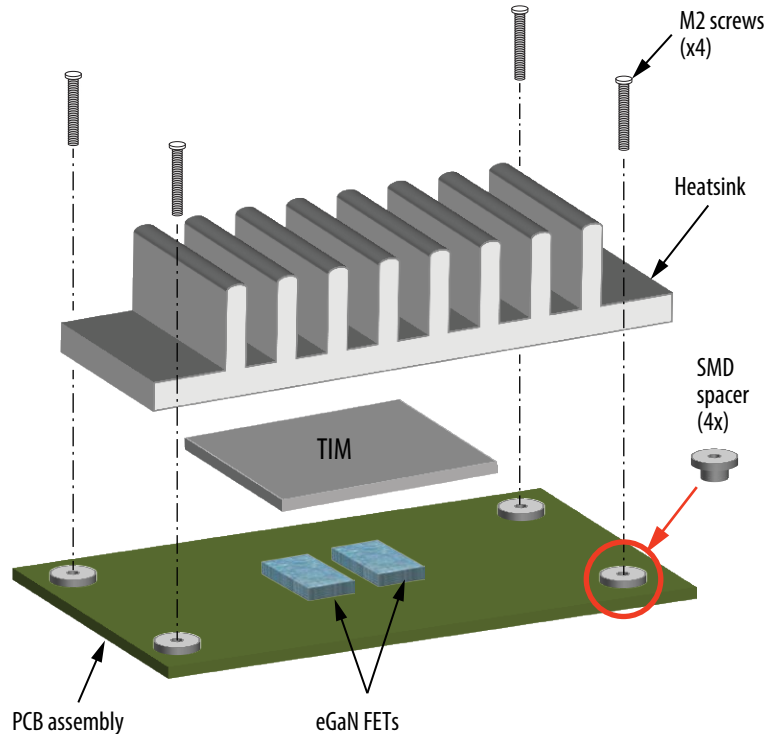

Figure 15: Exploded view of heatsink assembly using screws

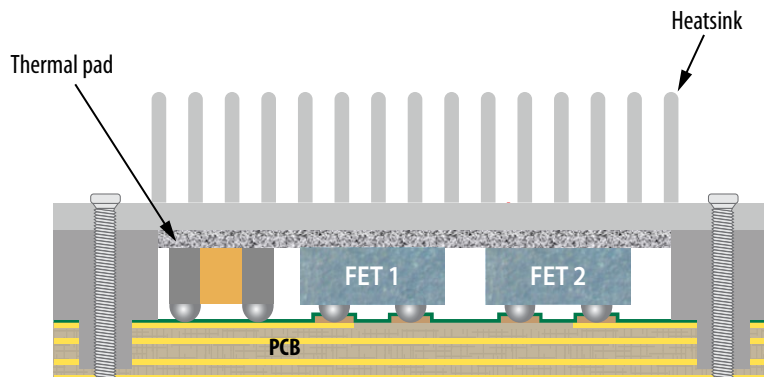

Figure 16: A cross-section image of dual sided thermal solution

Note: Connecting the heatsink to ground is recommended and can significantly improve radiated EMI

The thermal design can be optimized by using the [GaN FET Thermal Calculator](#) on EPC's website.

TAPE AND REEL CONFIGURATION

8 mm pitch, 12 mm wide tape on 7" reel

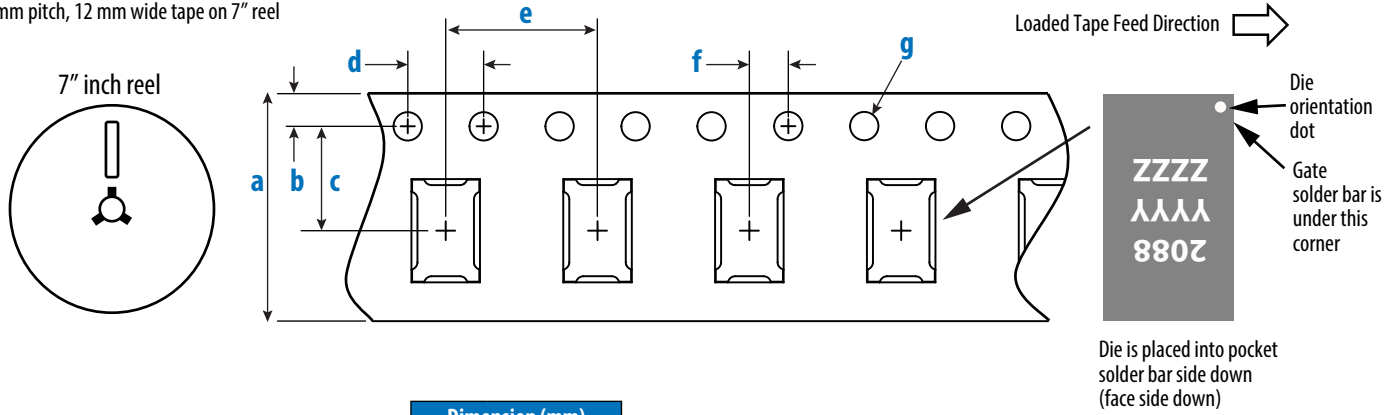

EPC2088 (Note 1)	Dimension (mm)		
	Target	MIN	MAX
a	12.00	11.90	12.30
b	1.75	1.65	1.85
c (Note 2)	5.50	5.45	5.55
d	4.00	3.90	4.10
e	8.00	7.90	8.10
f (Note 2)	2.00	1.95	2.05
g	1.50	1.50	1.60

Note 1: MSL 1 (moisture sensitivity level 1) classified according to IPC/JEDEC industry standard.

Note 2: Pocket position is relative to the sprocket hole measured as true position of the pocket, not the pocket hole.

DIE MARKINGS

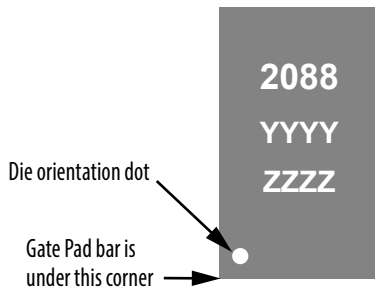

Part Number	Laser Markings		
	Part # Marking Line 1	Lot_Date Code Marking Line 2	Lot_Date Code Marking Line 3
EPC2088	2088	YYYY	ZZZZ

DIE OUTLINE

Solder Bump View

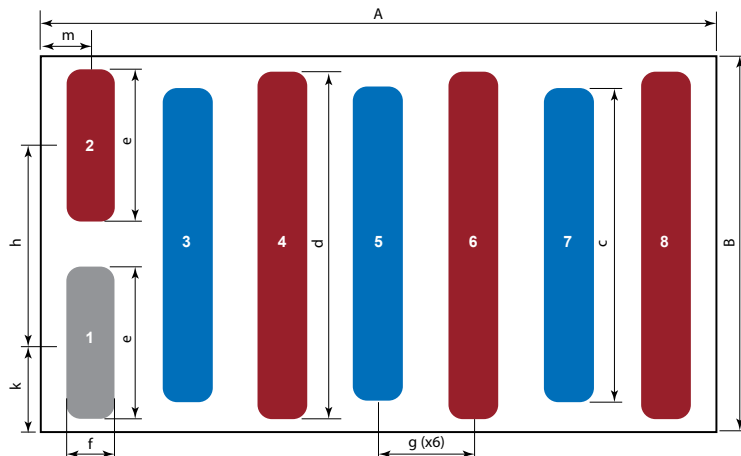

DIM	Micrometers		
	MIN	Nominal	MAX
A	3470	3500	3530
B	1920	1950	1980
C	1605	1625	1645
D	1780	1800	1820
E	755	775	795
F	230	250	270
G		500	
H		1025	
K		462.5	
M		250	

Side View

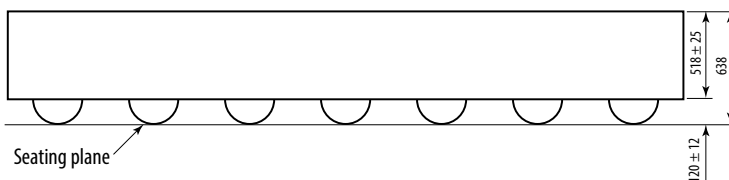

Solder bump material:
Solder Alloy Sn/1.8Ag : IPC/JEDEC J-STD-609 solder alloy e-code : e2

Pad 1 is Gate;

Pads 2, 4, 6, 8 are Source;

Pads 3, 5, 7 are Drain

Notes:

Substrate (top side) connected to Source.

Dimensions **d** and **c** are centered.

RECOMMENDED LAND PATTERN
(units in μm)

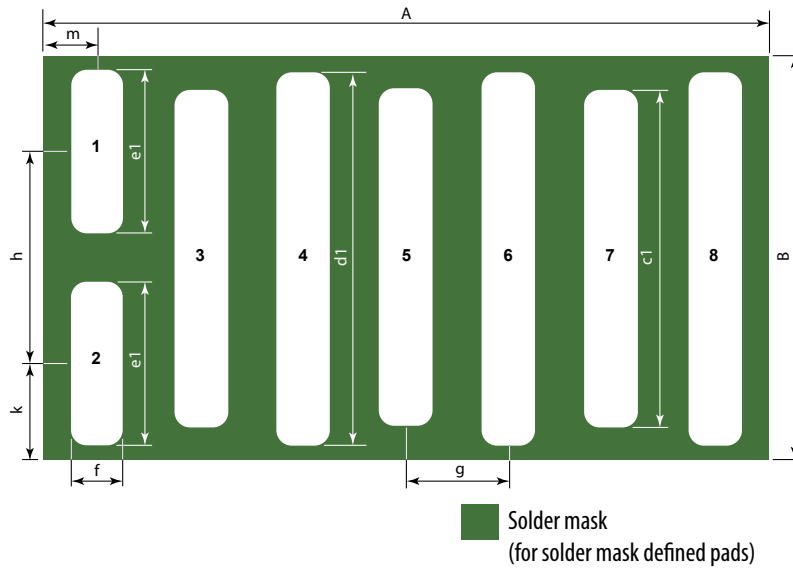

Land pattern is solder mask defined

DIM	Nominal
A	3500
B	1950
c1	1605
d1	1780
e1	755
f	230
g	500
h	1025
k	462.5
m	250

Pad 1 is Gate;
Pads 2, 4, 6, 8 are Source;
Pads 3, 5, 7 are Drain

RECOMMENDED STENCIL DRAWING
(units in μm)

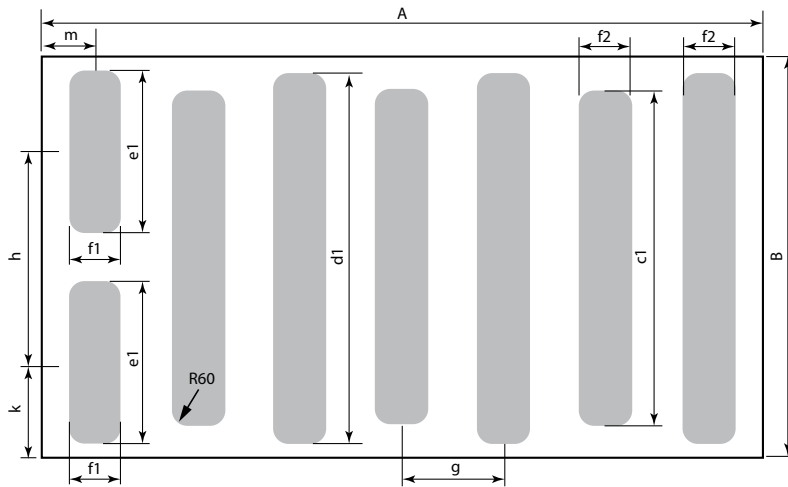

DIM	Nominal
A	3500
B	1950
c1	1605
d1	1780
e1	755
f1	230
f2	210
g	500
h	1025

Recommended stencil should be 4 mil (100 μm) thick, must be laser cut, openings per drawing. Intended for use with SAC305 Type 4 solder, reference 88.5% metals content.

The corner has a radius of R60.

Split stencil design can be provided upon request, but EPC has tested this stencil design and not found any scooping issues.

ADDITIONAL RESOURCES AVAILABLE

Solder mask defined pads are recommended for best reliability.

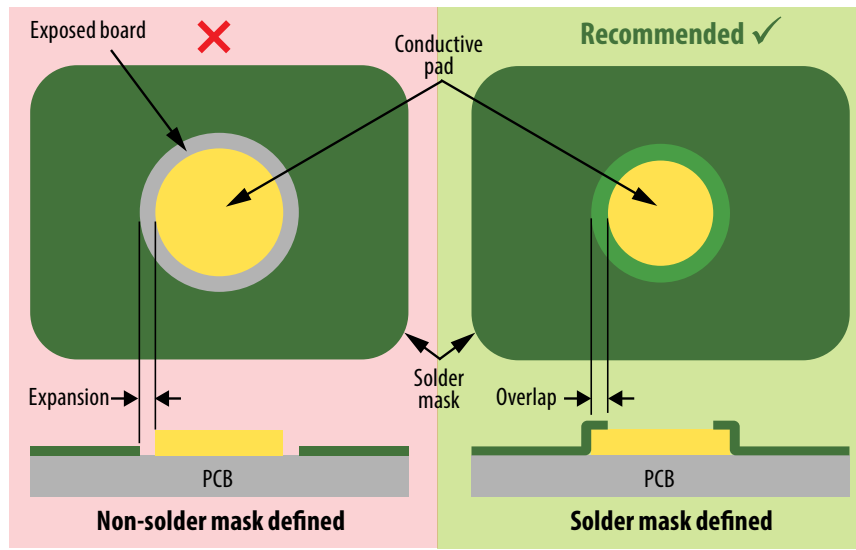

Figure 17: Solder mask defined versus non-solder mask defined pad

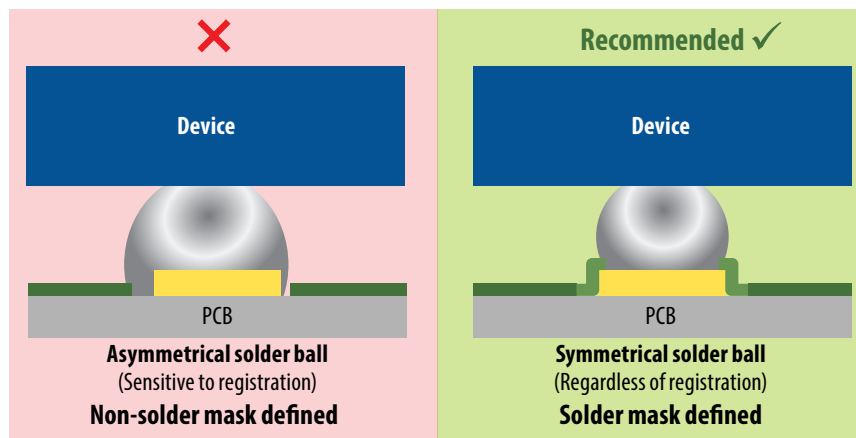

Figure 18: Effect of solder mask design on the solder ball symmetry

- Assembly resources – https://epc-co.com/epc/Portals/0/epc/documents/product-training/Appnote_GaNassembly.pdf
- Library of Altium footprints for production FETs and ICs – <https://epc-co.com/epc/documents/altium-files/EPC%20Altium%20Library.zip>
(for preliminary device Altium footprints, contact EPC)

Efficient Power Conversion Corporation (EPC) reserves the right to make changes without further notice to any products herein to improve reliability, function or design. EPC does not assume any liability arising out of the application or use of any product or circuit described herein; neither does it convey any license under its patent rights, nor the rights of others.

eGaN® is a registered trademark of Efficient Power Conversion Corporation.
EPC Patent Listing: epc-co.com/epc/AboutEPC/Patents.aspx

Information subject to change without notice.
Revised March, 2023