

ELECTRICAL SPECIFICATION

PARAMETER	SYMBOL	CONDITIONS	VALUE	UNIT
Nominal Frequency	fo	Ta=25°C	100.000	MHz
Supply Voltage	Vcc	Vcc ±5%	3.3	VDC
Supply Current, max	Is	Vcc; Ta=+25°C;	40	mA
Operating Temperature Range	Ta	---	-40 to +85	°C
Storage Temperature Range	T(stg)	Absolute max	-55 to +125	°C
Output Logic Type	---		LVDS	
Overall Freq. Stability, Max.	$\Delta f/fo$	Inclusive of 25°C Tolerance and Changes due to Operating Temperature, Supply Voltage, Load, Aging, Shock and Vibration	±25	ppm
Output Voltage	VO _L	Logic "0" Level	0.9 Min	VDC
	VO _H	Logic "1" Level	1.6 Max	VDC
Output Load	---	Connected between Out and Complementary Out	100	Ω
Enable / Disable Function	E/D	Pin 1: N.C. (Open) or High (0.7 x Vcc)	Pin 4 & 5 – Oscillation (Enabled)	
		Pin 1: Low (0.3 x Vcc)	Pin 4 & 5 – High Impedance (Disabled)	
Symmetry (Duty Cycle)	DC	@50% Vdd	45 to 55	%
Rise Time and Fall Time	tr / tf	@20% to 80% Vdd	1.0	ns
Jitter, RMS, max.	J	1σ, 12kHz < F _J < 20MHz	1.0	ps

MECHANICAL SPECIFICATION

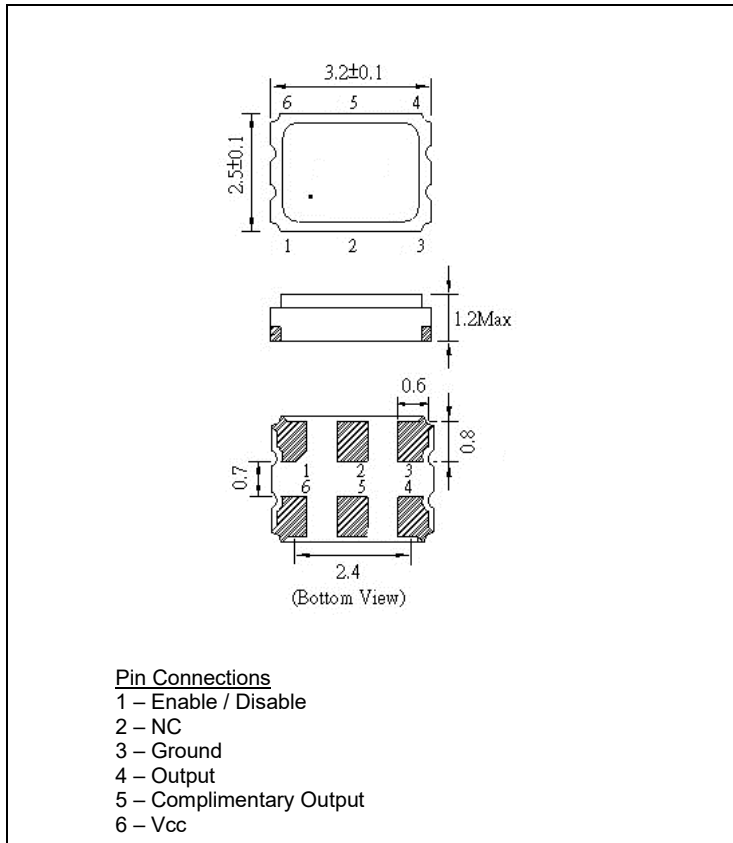

CARRIER TAPE DIMENSIONS

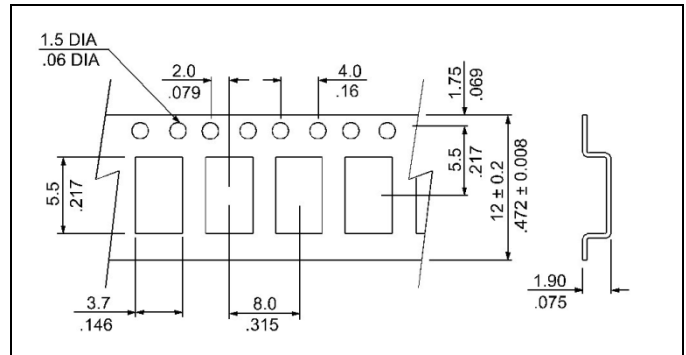

NOTE: REFER TO EIA-481 FOR DIMENSIONS NOT LISTED

PACKAGING

178 mm REEL DIAMETER
 12 mm TAPE WIDTH, 8 mm PITCH
 QUANTITY: 1000 PIECES PER REEL

REFLOW PROFILE

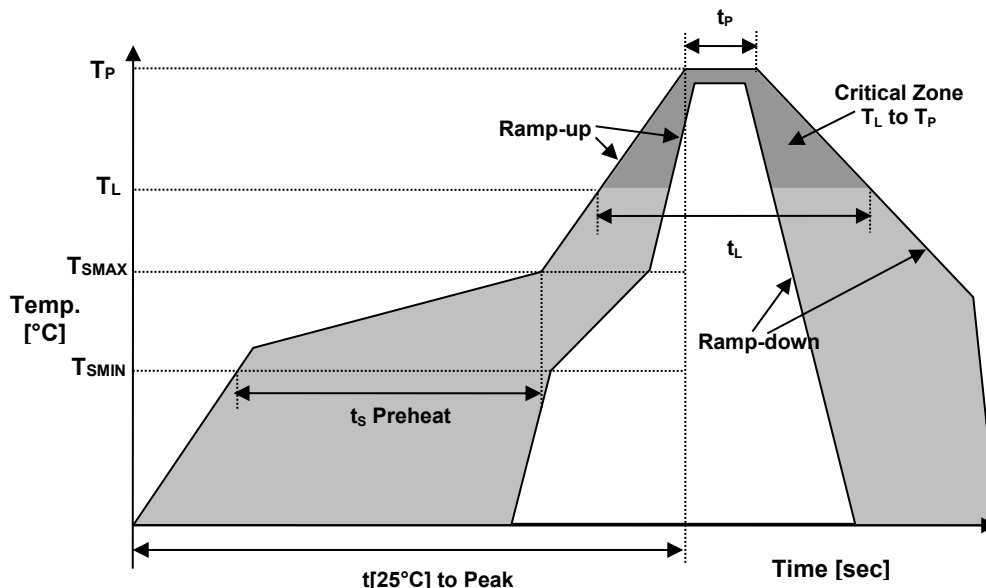

Reflow profile		
Temperature Min Preheat	T_{SMIN}	150°C
Temperature Max Preheat	T_{SMAX}	200°C
Time (T_{SMIN} to T_{SMAX})	t_s	60-180 sec.
Temperature	T_L	217°C
Peak Temperature	T_P	260°C
Ramp-up rate	R_{UP}	3°C/sec max.
Ramp-down rate	R_{DOWN}	6°C/sec max.
Time within 5°C of Peak Temperature	t_p	10 sec.
Time $t_{[25^\circ\text{C}]}$ to Peak Temperature	$t_{[25^\circ\text{C}]}$ to Peak	480 sec.
Time	t_L	60-150 sec.

ENVIRONMENTAL

PARAMETER	VALUE
MOISTURE SENSITIVITY LEVEL	1
RoHS	Compliant
REACH-SVHC	Compliant
HALOGEN-FREE	Compliant
TERMINATION FINISH	Au



MARKING

Rx100.0
•3AEyw

x – Internal Production ID code
y – Year code
w – Week code

YEAR CODE	
Year	Code
2015	5
2016	6
2017	7
2018	8
2019	9
2020	0
2021	1
2022	2
2023	3
2024	4
2025	5

ALPHA WEEK CODE TABLE					
Week	Code	Week	Code	Week	Code
1	a	19	s	37	K
2	b	20	t	38	L
3	c	21	u	39	M
4	d	22	v	40	N
5	e	23	w	41	O
6	f	24	x	42	P
7	g	25	y	43	Q
8	h	26	z	44	R
9	i	27	A	45	S
10	j	28	B	46	T
11	k	29	C	47	U
12	l	30	D	48	V
13	m	31	E	49	W
14	n	32	F	50	X
15	o	33	G	51	Y
16	p	34	H	52	Z
17	q	35	I		
18	r	36	J		

APPROVAL

RALTRON	
DRAWN BY:	AR, January 21, 2019
APPROVED BY:	CP, January 21, 2019
REVISION:	A, Initial Release