

For Your Creative Products

ELECTRONIC COMPONENTS



CONTENTS

TFT LCD 2

LCD Modules	2
-------------------	---

Imaging CMOS IMAGE SENSORS / CCDs 7

CMOS Image Sensors for Digital Cameras / Digital Camcorders	7
Progressive CCDs	8
1/3-type CCDs	10
1/4-type CCDs	10
DSPs for CCDs	11
CCD Peripheral ICs/LSIs	12

LSI SYSTEM LSIs 13

Touch Panel Controller	13
System LSIs	14
Touch Panel Controller Module	14

Analog ANALOG ICs 15

LED Drivers	15
AC-DC Conversion Type ICs for LED Lighting	16

LSI Imaging PACKAGES 17

CSP (Chip Size Package)	17
SiP (System in Package)	18
Package Lineup	20

OPTO OPTOELECTRONICS / IR DEVICES 21

Photocoupler Lineup	21
Photocouplers	22
Phototransistor Output Type	22
OPIC Output	25
Phototriac Coupler Lineup	27
Phototriac Couplers	28
Solid State Relay Lineup	30
Solid State Relays	31
DIP type	31
Photointerrupter Lineup	32
Photointerrupters <Transmissive type>	33
Single Phototransistor Output	33
OPIC Type	35
Photointerrupters <Reflective type>	36
Single Phototransistor Output	36
OPIC Output	37
Proximity Sensor	38
Proximity Sensor with Integrated Ambient Light Sensor	38
Proximity/Gesture Sensor with Integrated Ambient Light Sensor	39
UV Light Sensors	39
OPIC Light Detectors	40
Phototransistor Lineup	41
Phototransistors	41
PIN Photodiodes	42
Infrared Emitting Diode Lineup	43
Infrared Emitting Diodes	43
Optical-Electric Sensor Lineup	44
Distance Measuring Sensors	45
Dust Sensor Unit	47
IR Detecting Unit for Remote Control Lineup (Classified by Form)	48
IR Detecting Units for Remote Control	49

LED LEDs 50

ZENIGATA LEDs for Lighting 50
LEDs for LCD Backlights 53

LASER LASER DIODES 54

Laser Diodes..... 54

RF *Sensor* RF COMPONENTS / SENSOR 57

Europe: LNBS for Satellite Broadcast 57
Digital DBS Front-End Units 58
Front-End Units for ISDB-T/S 59
Front-End Units for DVB-T2/DTMB 59
Front-End Units for Digital Terrestrial and
Analog Terrestrial Broadcasting 60
One-Seg Tuner Module..... 61
Digital Terrestrial Front-End Unit with EWBS 61
Non-Contact Vital & Motion Sensor Module62
PM2.5 Sensor Module 63
Temperature and Humidity Sensor..... 63

INDEX..... 64

■LCD Modules

<For industrial appliances>

Display size (cm) ["]	Model No.	Dot format H × V (dot)	Pixel pitch H × V (mm)	Active area H × V (mm)	Display colors	Luminance (cd/m ²) (TYP.)	Interface	Power consumption (W) (TYP.)	Outline dimensions*1 W × H × D (mm) (TYP.)	Weight (g) (MAX.)	Remarks
8.8 [3.5]	LQ035Q3DG03	320 × RGB × 240	0.2205 × 0.2205	70.56 × 52.92	16.19 M	450	CMOS	0.8	76.9 × 63.9 × 4.7	TYP. 42	Long-life LED backlight
8.9 [3.5]	LQ035Q3DY01	240 × RGB × 320	0.2235 × 0.2235	53.64 × 71.52	260 k	600	CMOS	0.5	65.0 × 85.0 × 3.4	40	Advanced Super V, Low reflection technology
9.4 [3.7]	LS037V7DW05	480 × RGB × 640	0.117 × 0.117	56.16 × 74.88	16.77 M	250	CMOS	0.4	65.0 × 89.2 × 4.4	50	Advanced Super V, Transflective LCD, With resistive touch panel
	300					65.0 × 89.2 × 3.6			38	Advanced Super V, Transflective LCD	
11 [4.2]	LQ042T1DW01	480 × 272 × RGB	0.1935 × 0.1935	92.88 × 52.632	16.19 M	400	CMOS	2.5	109.5 × 69.0 × 9.6	85	Advanced Super V, Long-life LED backlight, Built-in LED backlight driver circuit
11 [4.3]	LQ043T1DG28	480 × 272 × RGB	0.198 × 0.198	95.04 × 53.856	260 k	300	CMOS	0.6	105.5 × 67.2 × 4.2	60	With resistive touch panel
	LQ043T1DG29					360			105.5 × 67.2 × 3.1	45	
	LQ043Y1DY01	480 × RGB × 800	0.117 × 0.117	56.16 × 93.6	16.77 M	315			62.46 × 105.9 × 2.1	30	Advanced Super V, Low reflection technology
14 [5.7]	LQ057Q3DC03	320 × 240 × RGB	0.36 × 0.36	115.2 × 86.4	260 k	500	CMOS	2.5	144.0 × 104.6 × 12.3	210	Long-life LED backlight, Built-in LED backlight driver circuit
16 [6.4]	LQ064V3DG06	640 × 480 × RGB	0.204 × 0.204	130.56 × 97.92	260 k	350	CMOS	3.0	161.3 × 117.0 × 12.0	TYP. 200	Long-life LED backlight, Built-in LED backlight driver circuit
	☆LQ064X3LW01	1 024 × RGB × 768	0.12675 × 0.12675	129.792 × 97.344	16.77 M	350	LVDS	5.3	153.4 × 122.0 × 9.9	220	Advanced Super V, Long-life LED backlight, Built-in LED backlight driver circuit
18 [7.0]	LQ070Y3LW01	800 × 480 × RGB	0.1905 × 0.1905	152.4 × 91.44	16.19 M	380	LVDS	2.7	170.0 × 110.0 × 9.0	TYP. 175	Advanced Super V, Long-life LED backlight
	LQ070Y3LG01				260 k	350		1.8	164.9 × 104.0 × 3.9	140	
21 [8.4]	LQ084V1DG43	640 × RGB × 480	0.267 × 0.267	170.88 × 128.16	260 k	370	CMOS	4.7	221.0 × 152.4 × 9.3	340	Long-life LED backlight, Built-in LED backlight driver circuit
	LQ084S3LG03	800 × RGB × 600	0.213 × 0.213	170.4 × 127.8	16.19 M	330	LVDS	4.1	199.5 × 154.0 × 11.6	320	Long-life LED backlight, Built-in LED backlight driver circuit
22 [8.5]	LQ085Y3DG18	800 × 480 × RGB	0.231 × 0.231	184.8 × 110.88	260 k	250	CMOS	4.1	222.7 × 133.6 × 10.0	TYP. 256	Built-in LED backlight driver circuit
23 [9.1]	LQ091B1LW01	822 × RGB × 260	0.267 × 0.267	219.474 × 69.42	16.77 M	380	LVDS	6.8	240.0 × 86.0 × 10.0	230	Advanced Super V, Long-life LED backlight, Built-in LED backlight driver circuit
26 [10.1]	LQ101K1LY05	1 280 × RGB × 800	0.1695 × 0.1695	216.96 × 135.6	16.77 M	400	LVDS	4.2	230.7 × 152.5 × 8.7	270	Advanced Super V, Low reflection technology, Long-life LED backlight, Built-in LED backlight driver circuit
	LQ101W3LG01	1 024 × RGB × 600	0.2175 × 0.2088	222.72 × 125.28	260 K	350		5.1	235.3 × 143.0 × 7.9	350	Long-life LED backlight, Built-in LED backlight driver circuit
26 [10.4]	LQ104V1DG81/LG81	640 × RGB × 480	0.33 × 0.33	211.2 × 158.4	260 k	450	CMOS/LVDS	5.6	246.5 × 179.3 × 12.5	TYP. 500	Long-life LED backlight, Built-in LED backlight driver circuit
	LQ104S1DG2C	800 × RGB × 600	0.264 × 0.264			350	CMOS	4.5	246.5 × 179.3 × 11.0	550	Long-life LED backlight, Built-in LED backlight driver circuit
	LQ104S1LG81					420	LVDS	6.1	246.5 × 179.3 × 12.5	500	Long-life LED backlight, Built-in LED backlight driver circuit

All products listed on this page are LED backlight models.

*1 Protrusions such as positioning bosses are not included.

(Note) Please note that the specifications are subject to change without prior notice for product improvement.

Notice

In the absence of confirmation by device specification sheets, SHARP takes no responsibility for any defects that may occur in equipment using any SHARP devices shown in catalogs, data books, etc.

Except where specially indicated, models listed on this page comply with the RoHS Directive*. For details, please contact SHARP.

*RoHS Directive: Prohibits use of lead, cadmium, hexavalent chromium, mercury and specific brominated flame retardants (PBBs and PBDEs), with certain exceptions.

Contact SHARP in order to obtain the latest device specification sheets before using any SHARP device.



■LCD Modules

<For industrial appliances> (cont'd)

Display size (cm) ["]	Model No.	Dot format H x V (dot)	Pixel pitch H x V (mm)	Active area H x V (mm)	Display colors	Luminance (cd/m ²) (TYP.)	Interface	Power consumption (W) (TYP.)	Outline dimensions*1 W x H x D (mm) (TYP.)	Weight (g) (MAX.)	Remarks
31 [12.1]	LQ121S1DG81	800 x RGB x 600	0.3075 x 0.3075	246.0 x 184.5	260 k	450	CMOS	6.2	276.0 x 209.0 x 11.0	650	Long-life LED backlight, Built-in LED backlight driver circuit
	LQ121S1LG84				260 k	450	LVDS	5.1	276.0 x 209.0 x 9.1	600	Long-life LED backlight, Built-in LED backlight driver circuit
	LQ121S1LG86					1 500		12.9			Long-life LED backlight, Built-in LED backlight driver circuit
	LQ121K1LG52	1 280 x RGB x 800	0.204 x 0.204	261.1 x 163.2	16.19 M	430	LVDS	6.0	278.0 x 184.0 x 8.6	550	Long-life LED backlight, Built-in LED backlight driver circuit
	☆LQ121K1LW56				16.77 M	320		5.2	278.0 x 184.0 x 10.2		Wide Viewing Angle Long-life LED backlight, Built-in LED backlight driver circuit
	☆LQ121K1LG58				16.19 M	700		5.8	278.0 x 184.0 x 8.6		Long-life LED backlight, Built-in LED backlight driver circuit
	LQ121X3LG02	1 024 x RGB x 768	0.240 x 0.240	245.8 x 184.3	260 k	1 200		9.7	259.0 x 205.0 x 7.5		Long-life LED backlight
38 [15.0]	LQ150X1LG11	1 024 x RGB x 768	0.297 x 0.297	304.1 x 228.1	16.19 M	600	LVDS	8.2	331.6 x 254.7 x 9.3	950	Long-life LED backlight, Built-in LED backlight driver circuit
	LQ150X1LG91					350		6.8			Long-life LED backlight, Built-in LED backlight driver circuit
	LQ150X1LG96					1 050		14.8			Built-in LED backlight driver circuit
	LQ150X1LX92				16.19 M	270	10.0	326.5 x 253.5 x 9.6	950	Advanced Super V, Long-life LED backlight, Built-in LED backlight driver circuit, Haze value 3%	
	LQ150X1LX95					400				Advanced Super V, Long-life LED backlight, Built-in LED backlight driver circuit, Haze value 3%	
	LQ150X1LX96					500				Advanced Super V, Long-life LED backlight, Built-in LED backlight driver circuit, Haze value 3%	
	☆LQ150X1LX9K					16.19 M				400	Advanced Super V, Long-life LED backlight, Built-in LED backlight driver circuit, Polarized sunglasses supported
	LQ150X1LW12				10 M	350	10.2	331.6 x 254.7 x 9.3	Advanced Super V, Long-life LED backlight, Built-in LED backlight driver circuit		
	LQ150X1LW95				16.19 M	400	10.0	326.5 x 253.5 x 9.6	950	Advanced Super V, Long-life LED backlight, Built-in LED backlight driver circuit	
	LQ150X1LW96					500				Advanced Super V, Long-life LED backlight, Built-in LED backlight driver circuit	

All products listed on this page are LED backlight models.

*1 Protrusions such as positioning bosses are not included.

(Note) Please note that the specifications are subject to change without prior notice for product improvement.

Notice

In the absence of confirmation by device specification sheets, SHARP takes no responsibility for any defects that may occur in equipment using any SHARP devices shown in catalogs, data books, etc.

Except where specially indicated, models listed on this page comply with the RoHS Directive*. For details, please contact SHARP. *RoHS Directive: Prohibits use of lead, cadmium, hexavalent chromium, mercury and specific brominated flame retardants (PBBs and PBDEs), with certain exceptions.

Contact SHARP in order to obtain the latest device specification sheets before using any SHARP device.



■LCD Modules

<For industrial appliances> (cont'd)

Display size (cm) ["]	Model No.	Dot format H x V (dot)	Pixel pitch H x V (mm)	Active area H x V (mm)	Display colors	Luminance (cd/m ²) (TYP.)	Interface	Power consumption (W) (TYP.)	Outline dimensions*1 W x H x D (mm) (TYP.)	Weight (g) (MAX.)	Remarks
40 [15.6]	☆LQ156T3LW03	1 366 x RGB x 768	0.252 x 0.252	344.232 x 193.536	16.77 M	400	LVDS	16.9	363.8 x 215.9 x 10.8	950	Advanced Super V, Long-life LED backlight, Built-in LED backlight driver circuit
	LQ156M1LG21	1 920 x RGB x 1 080	0.17925 x 0.17925	344.16 x 193.59	16.19 M	300/350/400/600	2ch LVDS	13.6 (600cd/m ²)	370.0 x 217.0 x 9.3		Long-life LED backlight, Built-in LED backlight driver circuit, With brightness control switch
	LQ156M3LW01				16.77 M	400		17.9	363.8 x 215.9 x 10.8		Advanced Super V, Long-life LED backlight, Built-in LED backlight driver circuit
47 [18.5]	☆LQ185M3LW01	1 920 x RGB x 1 080	0.213 x 0.21300	408.96 x 230.04	16.77 M	400	2ch LVDS	17.5	430.4 x 254.6 x 10.8	TYP. 1 120	Advanced Super V, Long-life LED backlight, Built-in LED backlight driver circuit
48 [19.0]	LQ190E1LW52	1 280 x RGB x 1 024	0.294 x 0.294	376.32 x 301.056	16.77 M	450	2ch LVDS	21.7	404.2 x 330.0 x 15.0	1 850	Advanced Super V, Long-life LED backlight
	LQ190E1LW72					350		19.6	396.0 x 323.6 x 11.5	1 300	Advanced Super V, Long-life LED backlight, Built-in LED backlight driver circuit
	LQ190E1LX75/T					350		19.6			Advanced Super V, Long-life LED backlight, Built-in LED backlight driver circuit, Haze value 3%
	LQ190N1LW01	1 680 x RGB x 1 050	0.24375 x 0.24375	409.5 x 255.9375		300		20.2	444.0 x 283.3 x 15.5	1 600	Advanced Super V, Long-life LED backlight, Built-in LED backlight driver circuit
51 [20.1]	LQ201U1LW31	1 600 x XYZ x 1 200	0.255 x 0.255	408.0 x 306.0	256 gray scale	1 000	2ch LVDS	25.7	436.0 x 335.0 x 20.4	2 400	Advanced Super V, Long-life LED backlight, Built-in LED backlight driver circuit, Monochrome
	LQ201U1LW32	1 600 x RGB x 1 200			16.77 M	330					Advanced Super V, Long-life LED backlight, Built-in LED backlight driver circuit
59 [23.1]	LQ231U1LW32	1 600 x RGB x 1 200	0.294 x 0.294	470.4 x 352.8	16.77 M	500	2ch LVDS	65.5	530.0 x 431.5 x 23.9	4 500	Advanced Super V, Long-life LED backlight, Built-in LED backlight driver circuit
69 [27.0]	★LQ270M1LX01	1 920 x RGB x 1 080	0.303 x 0.303	581.76 x 363.6	16.77 M	500	2ch LVDS	43.5	620.0 x 407.6 x 22.0	3 800	Advanced Super V, Long-life LED backlight

All products listed on this page are LED backlight models.

*1 Protrusions such as positioning bosses are not included.

(Note) Please note that the specifications are subject to change without prior notice for product improvement.

Notice

In the absence of confirmation by device specification sheets, SHARP takes no responsibility for any defects that may occur in equipment using any SHARP devices shown in catalogs, data books, etc.

Except where specially indicated, models listed on this page comply with the RoHS Directive*. For details, please contact SHARP.
*RoHS Directive: Prohibits use of lead, cadmium, hexavalent chromium, mercury and specific brominated flame retardants (PBBs and PBDEs), with certain exceptions.

Contact SHARP in order to obtain the latest device specification sheets before using any SHARP device.

☆New product
 ★Under development



<For monitors>

Display size (cm) ["]	Model No.	Number of pixels*1	Dot format H x V (dot)	Active area H x V (mm)	Display colors	Luminance (cd/m ²) (TYP.)	Interface	Outline dimensions*2 W x H x D (mm) (TYP.)	Backlight	Remarks
80.0 [31.5]	☆LQ315D1JG95	8 294 400	3 840 x RGB x 2 160	697.92 x 392.58	1.07B 10-bit	350	V-by-One	734.8 x 430.0 x 12.0 (26.5*3)	Edge-lit LED (without driver)	Super-high resolution and High color purity (AdobeRGB100%) by using IGZO*4 LCD, Wide viewing angle: L/R 178°/ U/D 178°, Response time [G to G]: 8 ms (Typ.)
	700									

*1 Pixel means a set of each RGB dot.

*2 Excluding FPC for connection and other protruding parts.

*3 The thickness of the control board section.

*4 IGZO: an oxide semiconductor consisting of In (Indium), Ga (Gallium), and Zn (Zinc).

(Note) Please note that the specifications are subject to change without prior notice for product improvement.

<For digital signage displays>

Display size (cm) ["]	Model No.	Dot format H x V (dot)	Pixel pitch H x V (mm)	Active area H x V (mm)	Display colors	Luminance (cd/m ²) (TYP.)	Interface	Interface Outline dimensions*1 W x H x D (mm) (TYP.)	Weight (kg)	Remarks
176.56 [69.5]	☆LQ695D3LG03	1 920 x RGB x 1 080	0.802 x 0.802	1 538.88 x 865.62	1.07B 8-bit + 2-bit FRC	350	LVDS	1 559.4 x 893.0 x 27.5	26.5±1.5	Backlight type: edge-lit LED (built-in driver) SFR (60 Hz input–60 Hz output) Viewing angle (L/R / U/D): 176° / 176° Orientation: portrait / landscape
	☆LQ695D3LG06					500				
	★LQ695D3LG07					700				
	★LQ695D1VG03	3 840 x RGB x 2 160	0.401 x 0.401	1 538.88 x 865.62	1.07B 8-bit + 2-bit FRC	350	V-by-One	1 559.4 x 893.0 x 27.5	27.5±1.5	
	★LQ695D1VG04					500				
	203.21 [80]	LK800D3LA28	1 920 x RGB x 1 080	0.9225 x 0.9225	1 771.20 x 996.30	1.07B 8-bit + 2-bit FRC	350	LVDS	1 820.2 x 1 045.3 x 34.4	
LK800D3LA38		500								
LK800D3LA48		700								
226.66 [90]	LQ900D3LA01	1 920 x RGB x 1 080	1.038 x 1.038	1 992.96 x 1 121.04	1.07B 8-bit + 2-bit FRC	350	LVDS	2 032.0 x 1 168.0 x 80.0	46.5±1.0	Backlight type: direct-lit LED (built-in driver) DFR (120 Hz input–120 Hz output) Viewing angle (L/R / U/D): 176° / 176° Orientation: landscape (LA01) : portrait / landscape (LA03)
	★LQ900D3LA03					500				

*1 Excluding FPC for connection and other protruding parts.

Notice

In the absence of confirmation by device specification sheets, SHARP takes no responsibility for any defects that may occur in equipment using any SHARP devices shown in catalogs, data books, etc.

Except where specially indicated, models listed on this page comply with the RoHS Directive*. For details, please contact SHARP.

*RoHS Directive: Prohibits use of lead, cadmium, hexavalent chromium, mercury and specific brominated flame retardants (PBBs and PBDEs), with certain exceptions.

Contact SHARP in order to obtain the latest device specification sheets before using any SHARP device.

<For wearable & mobile terminal device (low power consumption LCD)>

Display size (cm) ["]	Model No.	Dot format H × V (dot)	Pixel pitch H × V (mm)	Active area H × V (mm)	Display colors	Luminance (cd/m ²) (TYP.)	Interface	Power consumption ^{*1} (μW) (TYP.)	Outline dimensions ^{*2} W × H × D (mm) (TYP.)	Weight (g) (MAX.)	Remarks
2.4 [0.96]	☆LS010B7DH05	192 × 192	0.127 × 0.127	ø24.384	B/W	No B/L	Serial	40	29.7 × 30.5 × 1.645 (Octagonal)	3.0	
3.05 [1.2]	LS012B7DH02	240 × 240	0.127 × 0.127	ø30.48	B/W	No B/L	Serial	50	35.78 × 36.53 × 1.605 (Octagonal)	4.4	
3.2 [1.26]	LS013B7DH05	144 × 168	0.145 × 0.145	20.88 × 24.36	B/W	No B/L	Serial	35	24.68 × 30.00 × 0.745	1.1	
3.3 [1.28]	LS013B7DH03	128 × 128	0.180 × 0.180	23.04 × 23.04	B/W	No B/L	Serial	50	26.6 × 30.3 × 0.741	1.3	
3.4 [1.33]	LS013B7DH06	128 × RGB × 128	0.186 × 0.186	23.808 × 23.808	8 colors	No B/L	Serial	60	26.82 × 31.3 × 0.745	1.5	
6.9 [2.7]	LS027B7DH01	400 × 240	0.1470 × 0.1470	58.8 × 35.28	B/W	No B/L	Serial	175	62.8 × 42.82 × 1.64	10.6	
11.2 [4.4]	LS044Q7DH01	320 × 240	0.280 × 0.280	89.6 × 67.2	B/W	No B/L	Serial	600	94.8 × 75.2 × 1.64	29.3	

*1 Data update mode (Display pattern: Vertical stripe display)

*2 Protrusion such as positioning bosses are not included.

(Note) Please note that the specifications are subject to change without prior notice for product improvement.

Notice

In the absence of confirmation by device specification sheets, SHARP takes no responsibility for any defects that may occur in equipment using any SHARP devices shown in catalogs, data books, etc.

Except where specially indicated, models listed on this page comply with the RoHS Directive*. For details, please contact SHARP.

*RoHS Directive: Prohibits use of lead, cadmium, hexavalent chromium, mercury and specific brominated flame retardants (PBBs and PBDEs), with certain exceptions.

Contact SHARP in order to obtain the latest device specification sheets before using any SHARP device.



■ CMOS Image Sensors for Digital Cameras/Digital Camcorders

Optical format	Total pixels	Color filter	Model No.	Video performance	Resolution	Pixel size H × V (μm)	Sensitivity (mV/Lux-sec) TYP.	Package
					Image pixels (H × V)			
1 type	13 110 k	R, G, B primary color mosaic filters	RJ5DY1BA0LT	4K2K 60 fps	4 144 × 3 096	3.1 × 3.1	1 420	N-LCC120-R898
		B/W	RJ5DY2BA0LT				2 390	
2/3 type	2 320 k	R, G, B primary color mosaic filters	RJ52N1BA0LT	1 080p 120 fps	1 984 × 1 116	5.0 × 5.0	3 240	N-LCC120-R898A
		B/W	RJ52N2BA0LT				6 080	

Notice

In the absence of confirmation by device specification sheets, SHARP takes no responsibility for any defects that may occur in equipment using any SHARP devices shown in catalogs, data books, etc.
 Except where specially indicated, models listed on this page comply with the RoHS Directive*. For details, please contact SHARP.
 *RoHS Directive: Prohibits use of lead, cadmium, hexavalent chromium, mercury and specific brominated flame retardants (PBBs and PBDEs), with certain exceptions.
 Contact SHARP in order to obtain the latest device specification sheets before using any SHARP device.



High-Sensitivity Image Sensors for Security Usage

■ Progressive CCDs

Optical format	Total pixels	Model No.	Video performance	Color filter	Resolution	Pixel size H x V (μm)	Sensitivity*1 (mV) TYP.	Smear ratio (dB) TYP.	Package
					Image pixels (H x V)				
1/3 type	350 k	RJ33B3AA0DT*2	VGA 120 fps (1 ch output)	Primary color	660 x 494	7.4 x 7.4	3 000	-125	P-DIP024-0400
		RJ33B4AA0DT*2		B/W			4 500		
		RJ33B3AD0DT*2	VGA 200 fps (2 ch output)	Primary color			3 000		
		RJ33B4AD0DT*2		B/W			4 500		
	520 k	RJ3331AA0PB	NTSC 650 TV lines	Complementary color	976 x 494	5.0 x 7.4	1 500	-120	P-DIP016-0450
	610 k	RJ3341AA0PB	PAL 650 TV lines	Complementary color	976 x 582	5.0 x 6.3	950	-120	P-DIP024-0400
	1 350 k	RJ33J3CA0DT*2	1.3M 30 fps 720p 30 fps (1 ch output)	Primary color	1 320 x 976	3.75 x 3.75			
		RJ33J4CA0DT*2		B/W			1 430		
	2 170 k	RJ33N3AA0LT*2	1 080p 25 fps (1 ch output)	Primary color	1 928 x 1 088	2.8 x 2.8	470	-110	N-LCC040-R350B
				B/W			650		
		RJ33N3AD0LT*2	1 080p 50 fps (2 ch output)	Primary color			470		
				B/W			650		
1/2 type	2 170 k	1 080p 25 fps (1 ch output)	Primary color	1 928 x 1 088	3.65 x 3.65	750	-115		
			B/W			1 150			
		1 080p 50 fps (2 ch output)	Primary color			750			
			B/W			1 150			
1/1.8 type	2 100 k	2M 25 fps (1 ch output)	Primary color	1 644 x 1 236	4.4 x 4.4	1 100	-120	P-DIP028-0566	
			B/W			1 650			
	2 130 k	2M 50 fps (2 ch output)	Primary color			1 100			
			B/W			1 650			
	2 960 k	RJ31P3AA0DT*2	2.8M 17 fps (1 ch output)	Primary color	1 940 x 1 460	3.69 x 3.69	750	-115	
				B/W			1 150		
		RJ31P3AD0DT*2	2.8M 30 fps (2 ch output)	Primary color			750		
				B/W			1 150		

*1 The average G signal output voltage (the average output voltage in the case of the complementary color filter) when a 1,000-lux light source with a 90% reflector is imaged by a lens of F4 at 1/30 sec (1/25 sec in the case of RJ3341AA0PB) frame accumulation.

*2 This model is the next-generation model. Light efficiency including the near-infrared light region has been drastically improved by our process technology.

Notice

In the absence of confirmation by device specification sheets, SHARP takes no responsibility for any defects that may occur in equipment using any SHARP devices shown in catalogs, data books, etc.
 Except where specially indicated, models listed on this page comply with the RoHS Directive*. For details, please contact SHARP.
 *RoHS Directive: Prohibits use of lead, cadmium, hexavalent chromium, mercury and specific brominated flame retardants (PBBs and PBDEs), with certain exceptions.
 Contact SHARP in order to obtain the latest device specification sheets before using any SHARP device.

■ Progressive CCDs (cont'd)

Optical format	Total pixels	Model No.	Video performance	Color filter	Resolution	Pixel size H x V (μm)	Sensitivity*1 (mV) TYP.	Smear ratio (dB) TYP.	Package	
					Image pixels (H x V)					
2/3 type	5 240 k	RJ32S3AA0DT	5M 9 fps (1 ch output)	Primary color	2 456 x 2 058	3.45 x 3.45	530	-110	P-DIP028-0566	
		RJ32S4AA0DT		B/W			800			
		RJ32S3AD0DT	5M 15 fps (2 ch output)	Primary color			530			
		RJ32S4AD0DT		B/W			800			
		RJ32S3AF0DT*2	5M 30 fps (4 ch output)	Primary color			2 456 x 2 056			580
		RJ32S4AF0DT*2		B/W						870
1/1 type	6 090 k	RJ3DT3AA0DT*2	6M 8 fps (1 ch output)	Primary color	2 758 x 2 208	4.54 x 4.54	1 150	-125	P-DIP064-1000	
		RJ3DT4AA0DT*2		B/W			1 750			
		RJ3DT3AD0DT*2	6M 15 fps (2 ch output)	Primary color			1 150			
		RJ3DT4AD0DT*2		B/W			1 750			
		RJ3DT3AF0DT*2	6M 30 fps (4 ch output)	Primary color			1 150			
		RJ3DT4AF0DT*2		B/W			1 750			
	8 290 k	RJ3DV3AF0DT*2	8M 25 fps (4 ch output)	Primary color	3 320 x 2 496	3.88 x 3.88	750	-120		
		RJ3DV4AF0DT*2		B/W			1 100			
4/3 type	8 340 k	☆RJ3EV3EF0DT*2	8M 25 fps (4 ch output)	Primary color	3 848 x 2 168	5.14 x 5.14	1 500	-125	P-DIP064-1000B	
		☆RJ3EV4EF0DT*2		B/W			2 250			

*1 The average G signal output voltage when a 1,000-lux light source with a 90% reflector is imaged by a lens of F4 at 1/30 sec frame accumulation.

*2 This model is the next-generation model. Light efficiency including the near-infrared light region has been drastically improved by our process technology.

Notice

In the absence of confirmation by device specification sheets, SHARP takes no responsibility for any defects that may occur in equipment using any SHARP devices shown in catalogs, data books, etc.

Except where specially indicated, models listed on this page comply with the RoHS Directive*. For details, please contact SHARP.
*RoHS Directive: Prohibits use of lead, cadmium, hexavalent chromium, mercury and specific brominated flame retardants (PBBs and PBDEs), with certain exceptions.

Contact SHARP in order to obtain the latest device specification sheets before using any SHARP device.



■ 1/3-type CCDs

Total pixels	Standard		Model No.	Resolution		Pixel size H x V (μm)	Sensitivity* ¹ (mV) TYP.	Smear ratio (dB) TYP.	Package
				Horizontal TV lines	Image pixels (H x V)				
270 k		NTSC	RJ2315EA0PB	330	512 x 492	9.6 x 7.5	4 200	-140	P-DIP016-0450
			RJ2315FA0PB* ²				4 500		
320 k	PAL	RJ2325EA0PB	512 x 582		9.6 x 6.34	4 200			
		RJ2325FA0PB* ²				4 500			
410 k	NTSC	RJ2355DA0PB	480	768 x 494	6.4 x 7.5	2 700	-135		
		RJ2355EA0PB* ²				3 000			
470 k	PAL	RJ2365DA0PB		752 x 582	6.53 x 6.39	2 700			
		RJ2365EA0PB* ²				3 000			
520 k	NTSC	RJ2331BA0PB	650	976 x 494	5.0 x 7.4	2 400	-125		
		RJ2331CA0PB* ²				2 600			
610 k	PAL	RJ2341BA0PB		976 x 582	5.0 x 6.3	2 400			
		RJ2341CA0PB* ²				2 600			

*1 The average output voltage measured when imaging a 90% reflector illuminated by a 1,000-lux light source through an optical system set at an f number of F4.0.

*2 This model is the next-generation model. Light efficiency including the near-infrared light region has been drastically improved by our process technology.

■ 1/4-type CCDs

Total pixels	Standard		Model No.	Resolution		Pixel size H x V (μm)	Sensitivity* ¹ TYP. (mV)	Smear ratio TYP. (dB)	Package
				Horizontal TV lines	Image pixels (H x V)				
270 k		NTSC	RJ2411FA0PB	330	512 x 492	7.2 x 5.6	1 800	-130	P-DIP014-0400A
320 k		PAL	RJ2421FA0PB		512 x 582	7.2 x 4.73	1 650		
410 k	Color	NTSC	RJ2455DA0PB	480	768 x 494	4.9 x 5.6	1 350		
470 k		PAL	RJ2465DA0PB		752 x 582	5.0 x 4.77			
520 k		NTSC	RJ2431AA0PB	650	976 x 494	3.75 x 5.56	1 400		
610 k		PAL	RJ2441AA0PB		976 x 582	3.75 x 4.47			

*1 The average output voltage measured when imaging a 90% reflector illuminated by a 1,000-lux light source through an optical system set at an f number of F4.0.

Notice

In the absence of confirmation by device specification sheets, SHARP takes no responsibility for any defects that may occur in equipment using any SHARP devices shown in catalogs, data books, etc.
 Except where specially indicated, models listed on this page comply with the RoHS Directive*. For details, please contact SHARP.
 *RoHS Directive: Prohibits use of lead, cadmium, hexavalent chromium, mercury and specific brominated flame retardants (PBBs and PBDEs), with certain exceptions.
 Contact SHARP in order to obtain the latest device specification sheets before using any SHARP device.



■ DSPs for CCDs

Description	Model No.	Features		Package
CDS/PGA/ADC + DSP	LR36B16	For 270-k/320-k/410-k/470-k/ 520-k/610-kpixel CCDs	<CDS/PGA/ADC> High-speed S/H circuit, high-gain PGA circuit, 12-bit ADC <DSP> 75-ohm video amplifier, mechanical iris control function, 10-bit DAC, synchronous signal generation circuit, CCD drive timing generator, AE control function, AWB control function, LED light control function, DWDR (gamma transition function), lens shading correction function, auto white blemish compensation function, mirror image function, OSD function (5 languages: En., Ch., Fr., Por., Sp.), privacy mask function, highlight compensation, motion detection function, 2D noise reduction, high resolution function, AF detection value output, NTSC/PAL analog output, Y/C analog output, UYVY digital output (ITU-R BT656 compatible)	P-HQFN072-1010

Notice

In the absence of confirmation by device specification sheets, SHARP takes no responsibility for any defects that may occur in equipment using any SHARP devices shown in catalogs, data books, etc.
 Except where specially indicated, models listed on this page comply with the RoHS Directive*. For details, please contact SHARP.
 *RoHS Directive: Prohibits use of lead, cadmium, hexavalent chromium, mercury and specific brominated flame retardants (PBBs and PBDEs), with certain exceptions.
 Contact SHARP in order to obtain the latest device specification sheets before using any SHARP device.



●System Configuration Examples

<Color Security Camera System with Three-chip Configuration>

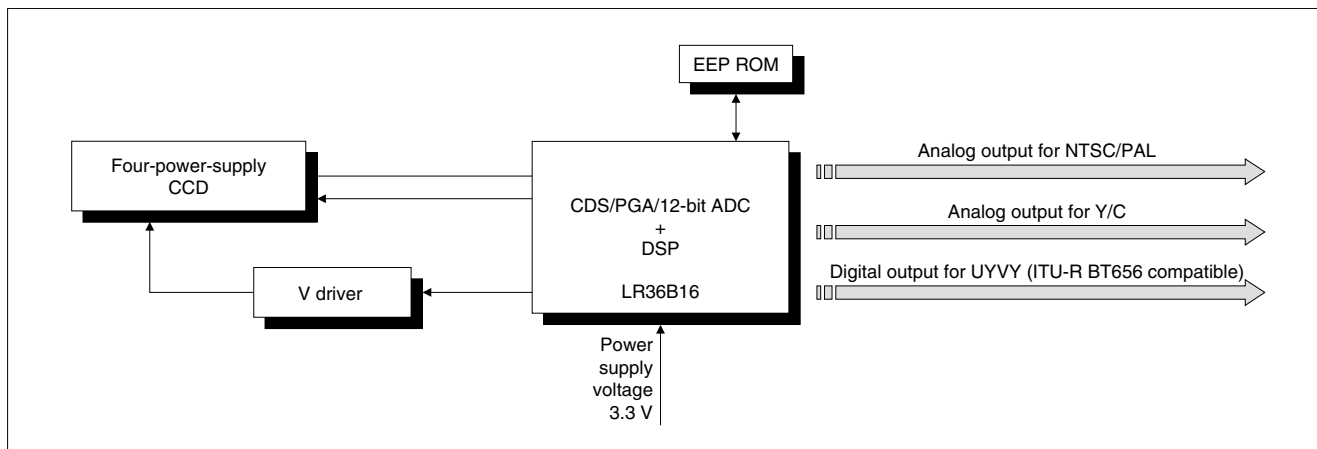

Four-power-supply CCDs and peripheral ICs/LSIs

CCD		CDS/PGA/ADC + DSP + Video amplifier	
1/3 type	270 kpixels	RJ2315EA0PB	LR36B16
		RJ2315FA0PB	
	320 kpixels	RJ2325EA0PB	
		RJ2325FA0PB	
	410 kpixels	RJ2355DA0PB	
		RJ2355EA0PB	
	470 kpixels	RJ2365DA0PB	
		RJ2365EA0PB	
	520 kpixels	RJ2331BA0PB	
		RJ2331CA0PB	
610 kpixels	RJ2341BA0PB		
	RJ2341CA0PB		
1/4 type	270 kpixels	RJ2411FA0PB	
	320 kpixels	RJ2421FA0PB	
	410 kpixels	RJ2455DA0PB	
	470 kpixels	RJ2465DA0PB	
	520 kpixels	RJ2431AA0PB	
	610 kpixels	RJ2441AA0PB	

Notice

In the absence of confirmation by device specification sheets, SHARP takes no responsibility for any defects that may occur in equipment using any SHARP devices shown in catalogs, data books, etc.
 Except where specially indicated, models listed on this page comply with the RoHS Directive*. For details, please contact SHARP.
 *RoHS Directive: Prohibits use of lead, cadmium, hexavalent chromium, mercury and specific brominated flame retardants (PBBs and PBDEs), with certain exceptions.
 Contact SHARP in order to obtain the latest device specification sheets before using any SHARP device.



■ Touch Panel Controller

● Features

1. **By adopting Sharp's proprietary method, approximately eight times more sensitivity (comparison by Sharp) has been achieved compared with the conventional sequential driving method.***

Capable of sensing a $\phi 2$ mm pen touch, multi-touch operation and touch operation using a glove.

2. **Contributes to a thinner design of a touch panel display.**

A thinner design is achievable because the design is insusceptible to the noise effect, which makes space for the sensor sheets and the display modules unnecessary.

* When comparing an S/N ratio of 3.58 determined through the conventional sequential driving method using pen-touch writing on a 20-inch screen with an S/N ratio of 30.65 determined through Sharp's proprietary parallel driving method (measured by Sharp).

● Application Examples

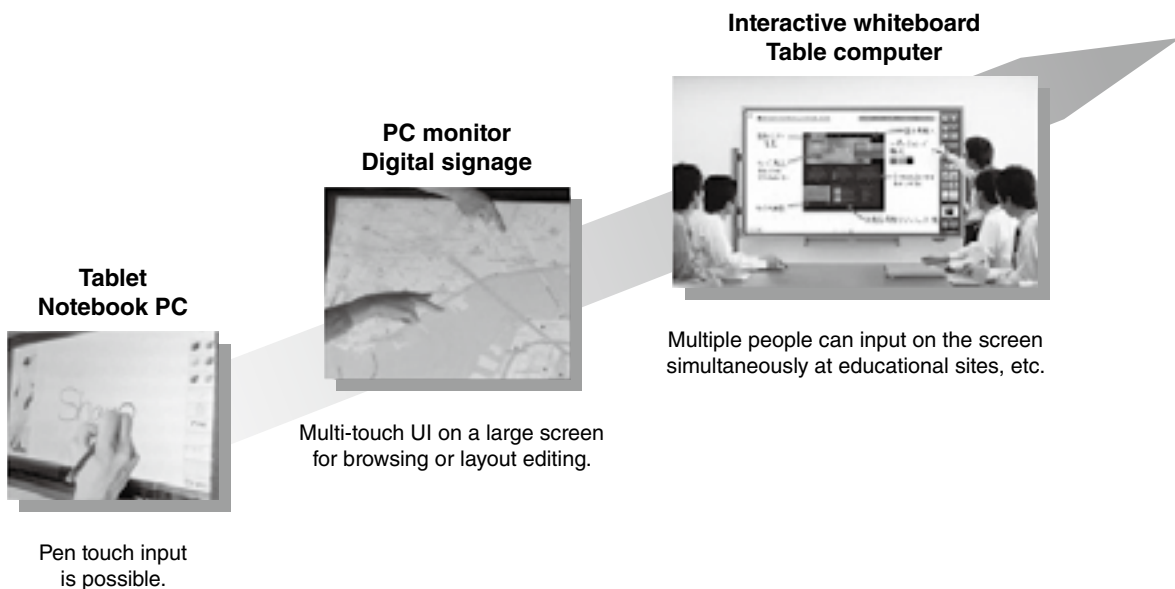

Notice

In the absence of confirmation by device specification sheets, SHARP takes no responsibility for any defects that may occur in equipment using any SHARP devices shown in catalogs, data books, etc.

Except where specially indicated, models listed on this page comply with the RoHS Directive*. For details, please contact SHARP.

*RoHS Directive: Prohibits use of lead, cadmium, hexavalent chromium, mercury and specific brominated flame retardants (PBBs and PBDEs), with certain exceptions.

Contact SHARP in order to obtain the latest device specification sheets before using any SHARP device.

■ System LSIs



Model No.	Function	Features	Supply voltage (V)	Package
LR388K4	Touch panel controller for tablets (7 to 10 inches)	<ul style="list-style-type: none"> • 10-finger multi-touch detection • Scanning speed: 240 Hz • Capable of sensing a $\phi 2$ mm pen touch • USB/I²C/SPI interface • Built-in palm cancellation feature 	Core: 1.2±0.12 I/O: 3.3±0.3 Analog: 3.3±0.3	P-VFBGA360P-0613

■ Touch Panel Controller Module



Model No.	Function	Features	Supply voltage (V)	Outline dimensions (W × D) (mm)
LR0G964	Touch panel controller module for medium-size screens (10 to 15.6 inches)	<ul style="list-style-type: none"> • 10-finger multi-touch detection • Scanning speed: 240 Hz • Capable of sensing a $\phi 2$ mm pen touch • Built-in palm cancellation feature • USB interface • Built-in power supply circuit 	5	74 × 46
☆LR0G970	Touch panel controller module for medium-size screens (15.6 to 27 inches)	<ul style="list-style-type: none"> • 10-finger multi-touch detection • Scanning speed: 240 Hz • Capable of sensing a $\phi 2$ mm pen touch • Built-in palm cancellation feature • USB interface • Built-in power supply circuit • Compatible with active pen 	5	50 × 90
LR0G967	Touch panel controller module for medium-size screens (15 to 32 inches)	<ul style="list-style-type: none"> • 10-finger multi-touch detection • Scanning speed: 240 Hz • Capable of sensing a $\phi 2$ mm pen touch • Built-in palm cancellation feature • USB interface • Built-in power supply circuit 	5	60 × 80
☆LR0G971	Touch panel controller module for large-size screens (Over 42 inches)	<ul style="list-style-type: none"> • 50-finger multi-touch detection • Scanning speed: 120 Hz • Capable of sensing a $\phi 2$ mm pen touch • Built-in palm cancellation feature • USB interface • Built-in power supply circuit 	5	100 × 220

Notice

In the absence of confirmation by device specification sheets, SHARP takes no responsibility for any defects that may occur in equipment using any SHARP devices shown in catalogs, data books, etc.
 Except where specially indicated, models listed on this page comply with the RoHS Directive*. For details, please contact SHARP.
 *RoHS Directive: Prohibits use of lead, cadmium, hexavalent chromium, mercury and specific brominated flame retardants (PBBs and PBDEs), with certain exceptions.
 Contact SHARP in order to obtain the latest device specification sheets before using any SHARP device.



LED Drivers

Built-in Step-up Circuit

Model No.	Function	Features	No. of output circuits	Number of LEDs	Booster method	Constant current circuit	Switching transistor	Input voltage range (V)	Output current (mA) MAX.	Oscillation frequency (Hz) TYP.	Package
IR2E58U	White LED driver for backlight	<ul style="list-style-type: none"> Capable of driving a maximum of 96 LEDs with 12 LEDs (in series) per channel Built-in step-up DC-DC converter High oscillation frequency (1.5 MHz) makes use of a small coil possible Capable of controlling brightness using PWM control Step-up output control according to LED-Vf 	8	96	PWM	○	○	4.5 to 28	40/ch	500 k to 1.5 M	24HQFN
IR2E71Y	LED driver for backlight and call alert display (auto brightness adjustment)	<ul style="list-style-type: none"> 2 ch (11 LEDs x 2 ch) LED driver for backlight Auto brightness adjustment backlight LED 6 ch RBG LED driver for illumination Built-in switching regulator for LCD backlight Built-in LCD controller power supply (+5.8 V / -5.8 V MAX.) LDO 1 ch Interface for digital-output proximity sensor with ambient light sensor Built-in general purpose input/output port (7 ch MAX.) 	Backlight 2 RGB 6	Backlight 22 RGB 6	PWM	○	○	3.0 to 4.5	Backlight 25.5/ch RGB 12.7/ch	10 k to 1 M	35WL-CSP
IR2E67M	White LED driver for backlight	<ul style="list-style-type: none"> Built-in 10 ch. constant-current control amplifier (external output transistor) Enables driving LEDs up to external transistor voltage limit Built-in timing controller for lighting Wider range of PWM brightness control possible, from simultaneous total output control to local dimming Step-up output control according to LED-Vf 	10	*2	*3	*4	External	4.5 to 5.5	*5	-	80LQFP-1420
IR2E70N	White LED driver for backlight	<ul style="list-style-type: none"> Built-in step-up DC-DC controller for 2 ch individual control Capable of 2 ch individual PWM brightness control LED current value adjustable by external signal (voltage input / PWM signal) Brightness control possible at high contrast ratio 3000:1 Step-up output control according to LED-Vf 	2	*2	PWM	*6	External	4.5 to 5.5 8 to 28	*5	100 k to 500 k	24SSOP

*1 Constant current (MAX.)

*2 Determined by external transistor voltage limit.

*3 Built-in feedback voltage-generating circuit for external power supply.

*4 Built-in constant-current control amplifier (external output transistor)

*5 Determined by external resistor.

*6 Constant current can be controlled by LED anode voltage control.

Notice

In the absence of confirmation by device specification sheets, SHARP takes no responsibility for any defects that may occur in equipment using any SHARP devices shown in catalogs, data books, etc.

Except where specially indicated, models listed on this page comply with the RoHS Directive*. For details, please contact SHARP.

*RoHS Directive: Prohibits use of lead, cadmium, hexavalent chromium, mercury and specific brominated flame retardants (PBBs and PBDEs), with certain exceptions.

Contact SHARP in order to obtain the latest device specification sheets before using any SHARP device.



■ AC-DC Conversion Type ICs for LED Lighting

Model No.	Features	Operating temperature range (°C)	Supply voltage range (V)	Dissipation current (mA) TYP.	Switching frequency (kHz) ^{*1} TYP.	Gate driver capacity		System	Package
						Low (Ω)	High (mA)		
IR3M92N4	Overvoltage/overheat/overcurrent circuits, high-speed activation, stand-by feature, PWM brightness control	-30 to +100	10 to 18	1	160	MAX. 15	MIN. 40	Flyback Step-down	SOP-8

*1 When operating a flyback converter

Notice

In the absence of confirmation by device specification sheets, SHARP takes no responsibility for any defects that may occur in equipment using any SHARP devices shown in catalogs, data books, etc.
 Except where specially indicated, models listed on this page comply with the RoHS Directive*. For details, please contact SHARP.
 *RoHS Directive: Prohibits use of lead, cadmium, hexavalent chromium, mercury and specific brominated flame retardants (PBBs and PBDEs), with certain exceptions.
 Contact SHARP in order to obtain the latest device specification sheets before using any SHARP device.



■ CSP

● CSP (Chip Size Package)

The FBGA (commonly known as CSP) has an area array terminal structure with solder balls on the bottom, to give it a near chip-size footprint. This high-density, compact and low-profile package technology will greatly help in the design of compact mobile equipment, such as mobile phones and digital cameras.



FBGA (CSP)

Features	<ul style="list-style-type: none"> ● Compact and lightweight Ability to create a near-chip size and lighter-weight package in comparison with conventional plastic packages. ● High reliability Comparable high reliability with that of conventional plastic packages. ● Mountability Conventional mounting system is available for CSP. SOP and QFP can be mounted together with CSP. 															
	<table border="1"> <tr> <td>Terminal pitch</td> <td>0.8 mm</td> <td>0.65 mm</td> <td>0.5 mm</td> <td>0.4 mm</td> </tr> <tr> <td>Maximum terminal counts</td> <td>352 (16 mm x 16 mm)</td> <td>352 (16 mm x 16 mm)</td> <td>372 (16 mm x 16 mm)</td> <td>264 (10 mm x 10 mm)</td> </tr> <tr> <td>Nominal dimensions</td> <td colspan="3">6 mm x 6 mm to 16 mm x 16 mm</td> <td>5 mm x 5 mm to 10 mm x 10 mm</td> </tr> </table>	Terminal pitch	0.8 mm	0.65 mm	0.5 mm	0.4 mm	Maximum terminal counts	352 (16 mm x 16 mm)	352 (16 mm x 16 mm)	372 (16 mm x 16 mm)	264 (10 mm x 10 mm)	Nominal dimensions	6 mm x 6 mm to 16 mm x 16 mm			5 mm x 5 mm to 10 mm x 10 mm
	Terminal pitch	0.8 mm	0.65 mm	0.5 mm	0.4 mm											
	Maximum terminal counts	352 (16 mm x 16 mm)	352 (16 mm x 16 mm)	372 (16 mm x 16 mm)	264 (10 mm x 10 mm)											
Nominal dimensions	6 mm x 6 mm to 16 mm x 16 mm			5 mm x 5 mm to 10 mm x 10 mm												

Cross section example	
------------------------------	--

● Wafer-level CSP

The wafer-level CSP (WL-CSP) is a kind of chip-size package which is manufactured by assembling directly onto the finished wafer.

Features	<ul style="list-style-type: none"> ● Compact and thinner size It makes it possible to create an almost IC-size and lighter-weight package. ● Mountability The conventional CSP mounting system can be also used in that of wafer-level CSP, which facilitates chip mounting more than bare-chip mounting does. It can be mounted together with other existing packages and passive components. 																					
	<table border="1"> <tr> <td>Chip size*</td> <td colspan="2">4 mm x 4 mm</td> <td colspan="2">3.5 mm x 3.5 mm</td> <td colspan="2">3 mm x 3 mm</td> </tr> <tr> <td>Pad pitch</td> <td>0.5 mm</td> <td>0.4 mm</td> <td>0.5 mm</td> <td>0.4 mm</td> <td>0.5 mm</td> <td>0.4 mm</td> </tr> <tr> <td>Maximum terminal counts</td> <td>49 (7 x 7)</td> <td>81 (9 x 9)</td> <td>36 (6 x 6)</td> <td>49 (7 x 7)</td> <td>25 (5 x 5)</td> <td>36 (6 x 6)</td> </tr> </table>	Chip size*	4 mm x 4 mm		3.5 mm x 3.5 mm		3 mm x 3 mm		Pad pitch	0.5 mm	0.4 mm	0.5 mm	0.4 mm	0.5 mm	0.4 mm	Maximum terminal counts	49 (7 x 7)	81 (9 x 9)	36 (6 x 6)	49 (7 x 7)	25 (5 x 5)	36 (6 x 6)
	Chip size*	4 mm x 4 mm		3.5 mm x 3.5 mm		3 mm x 3 mm																
	Pad pitch	0.5 mm	0.4 mm	0.5 mm	0.4 mm	0.5 mm	0.4 mm															
Maximum terminal counts	49 (7 x 7)	81 (9 x 9)	36 (6 x 6)	49 (7 x 7)	25 (5 x 5)	36 (6 x 6)																
<p>* Rectangular chip form is also available.</p>																						

Cross section example	
------------------------------	--



■ SiP (System in Package)

System in Package is SHARP's original high-density mounting technology that achieves high-density memory capacity and multiple functions by stacking multiple ICs or multiple packages. The System in Package technology means chip-stacked package technology that can achieve up to 5-chip mounting by stacking ICs in a single package. The System in Package technology contributes to higher functionality of applications, such as mobile phones and digital cameras, as well as to reduction in size and weight.

● Chip Stacked CSP

Features	<ul style="list-style-type: none"> ● Wide variety of lineup It is possible to provide a wide lineup of stacked CSPs, including 2-chip, 3-chip, 4-chip and 5-chip stacked CSPs, to respond to customer needs. ● Compact and thinner size Encapsulating multiple ICs into an existing plastic package contributes to decreasing the mounting area. In addition, SHARP's wafer thinning technology makes it possible to achieve 1.4 mm (MAX.) package height. ● Multiple functions Multiple ICs of different sizes and functions, such as logic LSIs and memories, can be incorporated in a single package, making possible multiple functions. ● Same-size IC stacking technology SHARP's stacking technology enables stacking of multiple same-size ICs, contributing to higher memory density. <p>(4-chip stacked CSP) When using a SHARP four-chip stacked CSP, the mounting area and weight of a package can be decreased by half in comparison with using two 2-chip stacked CSPs, or a 3-chip stacked CSP and a conventional CSP.</p>
-----------------	--

Cross section example	<p>(5-chip stacked CSP)</p> <p style="text-align: right;">* At 0.8 mm terminal pitch</p>
------------------------------	--

Notice
In the absence of confirmation by device specification sheets, SHARP takes no responsibility for any defects that may occur in equipment using any SHARP devices shown in catalogs, data books, etc.
Except where specially indicated, models listed on this page comply with the RoHS Directive*. For details, please contact SHARP.
*RoHS Directive: Prohibits use of lead, cadmium, hexavalent chromium, mercury and specific brominated flame retardants (PBBs and PBDEs), with certain exceptions.
Contact SHARP in order to obtain the latest device specification sheets before using any SHARP device.

●Chip Stacked TSOP/QFP*/VQFN/HQFN

<p>Features</p>	<ul style="list-style-type: none"> ● Decreased mounting area By encapsulating two identical or different types of ICs into a single conventional plastic package, the mounting area of the package can be decreased. ● Multiple functions Thanks to the incorporation of different sizes and functions of multiple ICs, such as logic LSIs and memories, the functionality increases. ● Higher memory density When incorporating two identical memory ICs into a single package, memory density doubles on the same mounting area.
<p>Cross section example</p>	<p>(TSOP, QFP*) (Hamburger type) (Turtle stack type)</p> <p>(VQFN) (HQFN)</p> <p>Package height 1.0 mm (MAX.)</p>

* Including TQFP and LQFP.

Notice

In the absence of confirmation by device specification sheets, SHARP takes no responsibility for any defects that may occur in equipment using any SHARP devices shown in catalogs, data books, etc.
 Except where specially indicated, models listed on this page comply with the RoHS Directive*. For details, please contact SHARP.
 *RoHS Directive: Prohibits use of lead, cadmium, hexavalent chromium, mercury and specific brominated flame retardants (PBBs and PBDEs), with certain exceptions.
 Contact SHARP in order to obtain the latest device specification sheets before using any SHARP device.

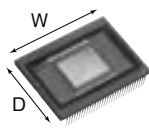
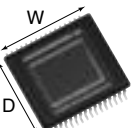
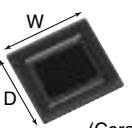

●For CCDs

Package type	Appearance (Package material)	Package code	No. of terminals	Terminal pitch mm	Nominal dimensions mm (mil)	Package depth & width (D x W) x (seated height [TYP.]) mm
DIP	 (Plastic)	P-DIP014-0400A	14	1.27	10.16 (400)	10.0 x 10.0
		P-DIP016-0450	16	1.27	11.43 (450)	11.4 x 12.2
		P-DIP020-0500	20	1.27	12.2 (500)	12.0 x 13.8
		P-DIP024-0400	24	0.80	10.16 (400)	10.0 x 10.0
		P-DIP028-0566	28	1.11	14.4 (566)	14.2 x 16.0
		P-DIP064-1000	64	1.00	25.48 (1 000)	36.1 x 25.4
		P-DIP064-1000B				
SOP	 (Plastic)	P-SOP014-0400A	14	1.27	12 (470)	10.0 x 10.0 x (4.1)
		P-SOP028-0400	28	0.69	10.16 (400)	10.0 x 10.0 x (3.5)
		P-SOP032-0525	32	0.78	13.3 (525)	12.0 x 13.8 x (3.92)
LCC	 (Ceramic)	N-LCC040-R350 (B)	40	0.65	8.9 (350)	8.3 x 8.9 x (1.52)
		N-LCC040-S433A		0.80	11.0 (433)	11.0 x 11.0 x (1.62)

100 mil = 2.54 mm

●For CMOSs

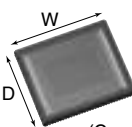
Package type	Appearance (Package material)	Package code	No. of terminals	Terminal pitch mm	Nominal dimensions mm (mil)	Package depth & width (D x W) x (seated height [TYP.]) mm
LCC	 (Ceramic)	N-LCC120-R898 ----- N-LCC120-R898A	120	0.65	22.8 (898)	20.0 x 22.8 x (2.67)

100 mil = 2.54 mm

Nominal dimensions

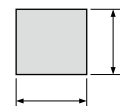

FBGA (CSP)
PBGA (BGA)

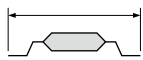

SOP
SSOP
MFP

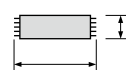

TSOP

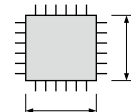

QFP
LQFP
TQFP

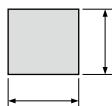

VQFN
HQFN

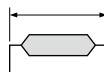

DIP



LCC

FBGA : fine-pitch ball grid array package

PBGA : plastic ball grid array package

SOP : small outline package

SSOP : shrink small outline package

MFP : mini flat package

TSOP : thin small outline package

QFP : quad flat package

LQFP : low profile quad flat package

TQFP : thin quad flat package

VQFN : very thin quad flat non-leaded package

HQFN : heat sink quad flat non-leaded package

DIP : dual inline package

LCC : leadless chip carrier

Ball Grid Array and BGA are trademarks of Motorola Nippon Ltd.

Notice

In the absence of confirmation by device specification sheets, SHARP takes no responsibility for any defects that may occur in equipment using any SHARP devices shown in catalogs, data books, etc.



Except where specially indicated, models listed on this page comply with the RoHS Directive*. For details, please contact SHARP. *RoHS Directive: Prohibits use of lead, cadmium, hexavalent chromium, mercury and specific brominated flame retardants (PBBs and PBDEs), with certain exceptions.

Contact SHARP in order to obtain the latest device specification sheets before using any SHARP device.





■ Photocoupler Lineup

<Phototransistor output type>

Package type	Output type	Features	Model No. (series)	Page		
Mini-flat 4-pin Compact, SMT type 	Single phototransistor	General purpose, High collector-emitter voltage	PC357NJ0000F / PC451J00000F	22		
		Low input current	PC367NJ0000F	22		
	Darlington phototransistor	AC input response	PC354NJ0000F	22		
		High sensitivity, High collector-emitter voltage	Low input current	PC364NJ0000F	22	
		Low input current	PC355NJ0000F / PC452J00000F	22		
Compact, Half pitch (lead space), SMT type 	Single phototransistor	General purpose, High resistance to noise, etc.	PC3H7J00000F	23		
		Reinforced insulation	PC3HU7xYIP0B	23		
	Darlington phototransistor	AC input response	Low input current	PC3H71xNIP0F	23	
			Low input current	PC3H3J00000F / PC3H4J00000F	23	
		High sensitivity	Low input current	PC3H41xNIP0F	23	
	Low input current	PC3H5J00000F	23			
		PC3H510NIP0F	23			
	DIP type (4-pin) (4-pin, DIP type) 	Single phototransistor	Reinforced insulation	PC123XNNSZ0F	24	
			Darlington phototransistor	General purpose, High collector-emitter voltage, etc.	Low input current	PC1231xNSZ0X
		Low input current			PC817XNNSZ0F / PC851XNNSZ0F	24
High sensitivity, High collector-emitter voltage		Low input current		PC8171xNSZ0X	24	
PC815XNNSZ0F▲ / PC852XNNSZ0F		24				

<OPIC output type>

Package type	Output type	Features	Model No. (series)	Page
Compact, SMT type 	Digital output	General purpose, High response speed	PC400J00000F	25
	Analog/Digital output	High CMR	PC457L0NIP0F	25
DIP type, SMT type 	Digital output	General purpose	PC900V0NSZXF▲	26
	Built-in drive circuit	For inverter control	PC925LENSZ0F▲	26

The model marked with ▲ may not be available in the near future. Contact with SHARP for details before use.



■ Photocouplers

◆ Phototransistor Output Type

<Compact, SMT type>

○: Approved

(Ta = 25°C)

Output type	Model No.	Internal connection diagram	Features	Approved by safety standards ^{*2}	Package	Absolute maximum ratings			Electro-optical characteristics						
				UL		Forward current I _F (mA)	Isolation voltage (AC) V _{iso} (rms) (kV)	Collector-emitter voltage V _{CEO} (V)	Current transfer ratio			Response time			
									CTR (%) MIN.	I _F (mA)	V _{CE} (V)	t _r (μs) TYP.	I _C (mA)	R _L (Ω)	V _{CE} (V)
Single phototransistor output	PC357NJ0000F		General purpose	○	Mini-flat 4-pin	50	3.75	80	50	5	5	4	2	100	2
	PC451J00000F		High collector-emitter voltage	○		50	3.75	350	40	5	5	4	2	100	2
	PC367NJ0000F		Low input current, high resistance to noise ^{*1}	○		10	3.75	80	100	0.5	5	4	2	100	2
	PC354NJ0000F		AC input response	○		±50	3.75	80	20	±1	5	4	2	100	2
	PC364NJ0000F		Low input current, AC input response, high resistance to noise ^{*1}	○		±10	3.75	80	50	±0.5	5	4	2	100	2
Darlington photo-transistor output	PC355NJ0000F		High sensitivity	○		50	3.75	35	600	1	2	60	2	100	2
	PC365NJ0000F		High sensitivity, low input current	○		10	3.75	35	600	0.5	2	60	10	100	2
	PC452J00000F		High collector-emitter voltage	○		50	3.75	350	1 000	1	2	100	20	100	2

*1 CMR: MIN. 10 kV/μs

*2 Please refer to Specification Sheets for model numbers approved by safety standards.



Notice

In the absence of confirmation by device specification sheets, SHARP takes no responsibility for any defects that may occur in equipment using any SHARP devices shown in catalogs, data books, etc.

Except where specially indicated, models listed on this page comply with the RoHS Directive*. For details, please contact SHARP.

*RoHS Directive: Prohibits use of lead, cadmium, hexavalent chromium, mercury and specific brominated flame retardants (PBBs and PBDEs), with certain exceptions.

Contact SHARP in order to obtain the latest device specification sheets before using any SHARP device.



◆ Phototransistor Output Type <Compact, half pitch (lead space) SMT type>

○: Approved

(Ta = 25°C)

Output type	Model No.	Internal connection diagram	Features	Approved by safety standards ³	Package	Absolute maximum ratings			Electro-optical characteristics						
				UL		Forward current I _F (mA)	Isolation voltage (AC) V _{iso} (rms) (kV)	Collector-emitter voltage V _{CE0} (V)	Current transfer ratio			Response time			
									CTR (%) MIN.	I _F (mA)	V _{CE} (V)	tr (μs) TYP.	I _C (mA)	R _L (Ω)	V _{CE} (V)
Single phototransistor output	PC3HU7xYIP0B		Reinforced insulation (internal insulation distance: MIN. 0.4 mm), low-profile package	○ ^{4, 5}	Low-profile mini-flat 4-pin	50	3.75	80	50	5	5	4	2	100	2
	PC3H7J00000F		Standard	○ ⁶		50	2.5	80	20	1	5	4	2	100	2
	PC3H71xNIP0F		High resistance to noise ^{*1} , low input current	○		10	2.5	80	100	0.5	5	4	2	100	2
	PC3H3J00000F		AC input response, high resistance to noise ^{*1}	○	Mini-flat 4-pin	±50	2.5	80	20	±1	5	4	2	100	2
	PC3H4J00000F		AC input response	○ ^{*2, 6}		±50	2.5	80	20	±1	5	4	2	100	2
	PC3H41xNIP0F		AC input response, high resistance to noise ^{*1} , low input current	○		±10	2.5	80	50	±0.5	5	4	2	100	2
Darlington photo-transistor output	PC3H5J00000F		High sensitivity	○	Mini-flat 4-pin	50	2.5	35	600	1	2	60	2	100	2
	PC3H510NIP0F		High sensitivity, low input current	○		10	2.5	35	600	0.5	2	60	2	100	2

- *1 CMR: MIN.10 kV/μs
- *2 A VDE approved type is optionally available.
- *3 Please refer to Specification Sheets for model numbers approved by safety standards.
- *4 VDE, CSA approved
- *5 In conformance with BSI, SEMKO, DEMKO, NEMKO, and FIMKO
- *6 UL, cUL approved

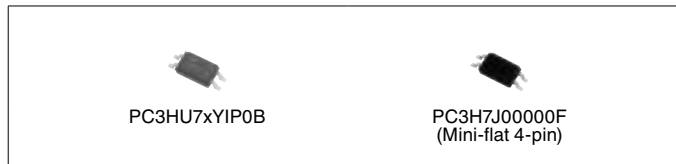

PC3HU7xYIP0B

PC3H7J00000F
(Mini-flat 4-pin)

Notice

In the absence of confirmation by device specification sheets, SHARP takes no responsibility for any defects that may occur in equipment using any SHARP devices shown in catalogs, data books, etc.
 Except where specially indicated, models listed on this page comply with the RoHS Directive*. For details, please contact SHARP.
 *RoHS Directive: Prohibits use of lead, cadmium, hexavalent chromium, mercury and specific brominated flame retardants (PBBs and PBDEs), with certain exceptions.
 Contact SHARP in order to obtain the latest device specification sheets before using any SHARP device.



◆ Phototransistor Output Type <DIP type (4-pin)>

○: Approved

(Ta = 25°C)

Output type	Model No.	Internal connection diagram	Features	Approved by safety standards ^{*8}			Package	Absolute maximum ratings			Electro-optical characteristics			
				UL	VDE ^{*2}	Others ^{*3}		Forward current I _F (mA)	Isolation voltage (AC) V _{iso} (rms) (kV)	Collector-emitter voltage V _{CEO} (V)	Current transfer ratio CTR (%) MIN.	I _F (mA)	t _r (μs) TYP.	R _L (Ω)
Single phototransistor output	PC123XNNSZ0F ^{*1, *5, *6, *7}		High isolation voltage, reinforced insulation	○	○	○	4-pin DIP	50	5.0	70	50	5	4	100
	PC1231xNSZ0X ^{*1}		High isolation voltage, reinforced insulation, low input current, high resistance to noise ^{*4}	○	○	○		10	5.0	70	50	0.5	4	100
	PC817XNNSZ0F ^{*5, *6, *7}		High isolation voltage	○	-	○ ^{*9}		50	5.0	80	50	5	4	100
	PC8171xNSZ0X ^{*5, *6}		High isolation voltage, low input current, high resistance to noise ^{*4}	○	-	-		10	5.0	80	100	0.5	4	100
	PC851XNNSZ0F ^{*5, *6}		High isolation voltage, high collector-emitter voltage	○	-	-		50	5.0	350	40	5	4	100
Darlington phototransistor output	PC815XNNSZ0F▲ ^{*5, *6}		High isolation voltage, high sensitivity	○	-	-	50	5.0	35	600	1	60	100	
	PC852XNNSZ0F ^{*5, *6}		High isolation voltage, high collector-emitter voltage	○	○	-	50	5.0	350	1 000	1	100	100	

^{*1} Wide lead spacing type is also available. Creepage distance: 6.4 mm or more, wide lead spacing type: 8 mm or more.

^{*2} Optionally available.

^{*3} BSI, SEMKO, DEMKO, NEMKO, FIMKO, CSA

^{*4} CMR: 10 kV/μs MIN.

^{*5} Lead forming type is also available for surface mounting.

^{*6} Taped package of lead forming type for surface mounting is also available.

^{*7} Wide lead spacing type is also available. Compatible with wide lead spacing type lead-forming models for surface-mount use. Also compatible with taped packages for wide lead spacing type lead-forming models for surface-mount use.

^{*8} Please refer to Specification Sheets for model numbers approved by safety standards.

^{*9} UL, CSA approved

The model marked with ▲ may not be available in the near future. Contact with SHARP for details before use.



Notice

In the absence of confirmation by device specification sheets, SHARP takes no responsibility for any defects that may occur in equipment using any SHARP devices shown in catalogs, data books, etc.

Except where specially indicated, models listed on this page comply with the RoHS Directive*. For details, please contact SHARP.
*RoHS Directive: Prohibits use of lead, cadmium, hexavalent chromium, mercury and specific brominated flame retardants (PBBs and PBDEs), with certain exceptions.

Contact SHARP in order to obtain the latest device specification sheets before using any SHARP device.



◆ **OPIC Output** (“OPIC” (Optical IC) is a trademark of SHARP Corporation. An OPIC consists of a light-detecting element and signal-processing circuit integrated onto a single chip.)

<Compact, SMT type> (1-1)

○: Approved

(Ta = 25°C)

Model No.	Internal connection diagram	Features	Approved by safety standards*2		Package	Absolute maximum ratings		Electro-optical characteristics*1						
			UL	VDE*3		Forward current I _F (mA)	Isolation voltage (AC) V _{iso} (rms) (kV)	Low level output voltage			Threshold input current			
								V _{OL} (V) MAX.	T _a (°C)	I _{OL} (mA)	I _F (mA)	I _{FHL} (mA) MAX.	I _{FLH} (mA) MAX.	R _L (Ω)
PC400J00000F		Digital output, normal-off operation	○	—	Mini-flat 5-pin	50	3.75	0.4	0 to +70	16	4	2.0	—	280

A: Rated voltage circuit

*1 Each item is measured at V_{CC}=5V. (PC400)

*2 Please refer to Specification Sheets for model numbers approved by safety standards.

*3 Optionally available.

<Compact, SMT type> (1-2)

○: Approved

(Ta = 25°C)

Model No.	Internal connection diagram	Features	Approved by safety standards*1		Package	Absolute maximum ratings		Electro-optical characteristics							
			UL	VDE*2		Forward current I _F (mA)	Isolation voltage (AC) V _{iso} (rms) (kV)	Current transfer ratio				Propagation delay time			
								CTR (%) MIN.	I _F (mA)	V _O (V)	V _{CC} (V)	t _{PHL} (μs) TYP.	t _{PLH} (μs) TYP.	R _L (Ω)	I _F (mA)
PC457LONIP0F		High speed (1 Mb/s), high CMR (15 kV/μs), for flow soldering	○	○	Mini-flat 5-pin	25	3.75	19	16	0.4	4.5	0.2	0.4	1 900	16

*1 Please refer to Specification Sheets for model numbers approved by safety standards.

*2 Optionally available.



Notice

In the absence of confirmation by device specification sheets, SHARP takes no responsibility for any defects that may occur in equipment using any SHARP devices shown in catalogs, data books, etc.
 Except where specially indicated, models listed on this page comply with the RoHS Directive*. For details, please contact SHARP.
 *RoHS Directive: Prohibits use of lead, cadmium, hexavalent chromium, mercury and specific brominated flame retardants (PBBs and PBDEs), with certain exceptions.
 Contact SHARP in order to obtain the latest device specification sheets before using any SHARP device.



◆ **OPIC Output** (“OPIC” (Optical IC) is a trademark of SHARP Corporation. An OPIC consists of a light-detecting element and signal-processing circuit integrated onto a single chip.)

<DIP type, digital output>

○: Approved

(Ta = 25°C)

Model No.	Internal connection diagram	Features	Approved by safety standards ⁵		Package	Absolute maximum ratings		Electro-optical characteristics ¹						
			UL	VDE ₄		Forward current I _F (mA)	Isolation voltage (AC) V _{iso} (rms) (kV)	Low level output voltage			Threshold input current			
								V _{OL} (V) MAX.	T _a (°C)	I _{OL} (mA)	I _F (mA)	I _{FHL} (mA) MAX.	I _{FLH} (mA) MAX.	R _L (Ω)
PC900V0NSZXF▲ ^{*2, *3}		Digital output, normal-off operation	○	○	6-pin DIP	50	5.0	0.4	0 to +70	16	4	2.0	-	280

A: Rated voltage circuit

*1 Each item is measured at V_{CC}=5V.

*2 Lead forming type is also available for surface mounting.

*3 Taped package of lead forming type for surface mounting is also available.

*4 Optionally available.

*5 Please refer to Specification Sheets for model numbers approved by safety standards.

The model marked with ▲ may not be available in the near future. Contact with SHARP for details before use.

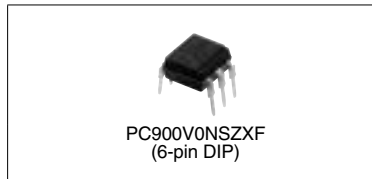

◆ **OPIC Output** (“OPIC” (Optical IC) is a trademark of SHARP Corporation. An OPIC consists of a light-detecting element and signal-processing circuit integrated onto a single chip.)

<DIP type, Gate drive type>

○: Approved

(Ta = 25°C)

Model No.	Internal connection diagram	Features	Approved by safety standards ³		Package	Absolute maximum ratings		Electro-optical characteristics					
			UL	VDE ₂		Forward current I _F (mA)	Isolation voltage (AC) V _{iso} (rms) (kV)	Propagation delay time					
								t _{PHL} (μs) TYP.	t _{PLH} (μs) TYP.	V _{CC} (V)	I _F (mA)	R _{L1} (Ω)	R _{L2} (Ω)
PC925LENSZ0F▲ ^{*1}		<ul style="list-style-type: none"> Built-in drive circuit directly connectable to MOS-FET and IGBT Peak output current: 2.5 A Low dissipation current (I_{CC} = TYP. 2.5 mA) High resistance to noise (CMR: MIN. 15 kV/μs) 	○	○	8-pin DIP	25	5.0	MAX. 0.5	MAX. 0.5	15 to 30	7 to 16	R _G = 10	-

*1 Lead forming type is also available for surface mounting. Taped package of lead forming type for surface mounting is also available.

*2 A VDE approved type is optionally available.

*3 Please refer to Specification Sheets for model numbers approved by safety standards.

The model marked with ▲ may not be available in the near future. Contact with SHARP for details before use.



Notice

In the absence of confirmation by device specification sheets, SHARP takes no responsibility for any defects that may occur in equipment using any SHARP devices shown in catalogs, data books, etc.

Except where specially indicated, models listed on this page comply with the RoHS Directive*. For details, please contact SHARP.

*RoHS Directive: Prohibits use of lead, cadmium, hexavalent chromium, mercury and specific brominated flame retardants

(PBBs and PBDEs), with certain exceptions.

Contact SHARP in order to obtain the latest device specification sheets before using any SHARP device.

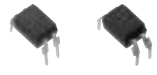
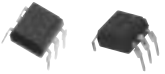

■ Phototriac Coupler Lineup

Package	Applied voltage	ON-state current (rms)	Features	Model No.	Page		
Mini-flat (SMD) 	AC 200 V lines (V _{DRM} = 600V)	0.05 A	General purpose	S2S3A00F ^{*3} / S2S5A00F ^{*3} / S2S5FA0F ^{*3}	28		
			Built-in zero-cross circuit	S2S4A00F ^{*3}	29		
DIP type (4-pin) 	AC 200 V lines (V _{DRM} = 600V)	0.1 A	General purpose	PC3ST11NSZKF	28		
			Reinforced isolation	PC3SH11YFZAF ^{*3} / PC3SH13YFZAF ^{*3}	28		
			Built-in zero-cross circuit	PC3SH21YFZBX ^{*2}	29		
DIP type (6-pin package, 5th-pin cut) 	AC 100 V lines (V _{DRM} = 400V)	0.1 A	General purpose	PC2SD11NTZAF ^{▲*3}	28		
			General purpose	PC3SD12NTZAF ^{*3} / PC3SD11YTZCF ^{*1} / PC3SD11NTZCF ^{*1} / PC3SD13YXZBF ^{*2}	28		
				Built-in zero-cross circuit	PC3SD21NTZAF ^{*3} / PC3SD21NTZBF ^{*2} / PC3SD21NTZDF ^{*4}	29	
			Reinforced isolation	PC3SF11YVZAF ^{*3} / PC3SF11YVZBF ^{*2}	28		
				Built-in zero-cross circuit	PC3SF21YVZAF ^{*3} / PC3SF21YVZBF ^{*2}	29	
			AC 200 V lines (V _{DRM} = 800V)	0.1 A	General purpose	PC4SD11NTZCF ^{*1}	28
					Built-in zero-cross circuit	PC4SD21NTZCF ^{*1} / PC4SD21NTZDF ^{*4}	29
					Reinforced isolation	PC4SF11YTZBF ^{*2}	28
			Built-in zero-cross circuit	PC4SF21YVZBF ^{*2} / PC4SF21YWPSF ^{*2}	29		

Minimum trigger current: *1 I_{FT} ≤ 5 mA, *2 I_{FT} ≤ 7 mA, *3 I_{FT} ≤ 10 mA, *4 I_{FT} ≤ 3 mA
 The model marked with ▲ may not be available in the near future. Contact with SHARP for details before use.



Phototriac Couplers

○: Approved

(Ta = 25°C)

Model No.	Internal connection diagram	Features	Approved by safety standards ^{*4}			Package	Absolute maximum ratings			Electro-optical characteristics
			UL, CSA	VDE	Others		ON-state current I _T (rms) (A)	Repetitive peak OFF-state voltage V _{DRM} (V)	Isolation voltage (AC) V _{iso} (rms) (kV)	
S2S3A00F		200 V lines, compact	○	○*6	—	Mini-flat 4-pin	0.05	600	3.75	10
S2S5A00F		200 V lines, compact	○	○*6	—					10
S2S5FA0F		High impulse noise product	○	○*6	—					10
PC3ST11NSZKF		200 V lines, compact	○	○*6	—	4-pin DIP	0.1	5.0	5.0	10
PC3SH11YFZAF		200 V lines, compact, reinforced isolation	○	○	○*2					10
PC3SH13YFZAF		200 V lines, compact, reinforced isolation, high noise resistance	○	○	○*2					10
PC2SD11NTZAF▲		100 V lines	○	—	—	6-pin DIP*1, 3	0.1	5.0	5.0	10
PC3SD12NTZAF		200 V lines	○	○*6	—					10
PC3SD13YXZBF		High impulse noise product	○	○*6	—					7
PC3SD11YTZCF		200 V lines	○	○*6	—					5
PC3SD11NTZCF		200 V lines	○	○*6	—					5
PC4SD11NTZCF		200 V lines, repetitive peak-OFF-state voltage	○	○*6	—					5
PC3SF11YVZAF		200 V lines, reinforced isolation	○	○	○*2					10
PC3SF11YVZBF		200 V lines, reinforced isolation	○	○	○*2					7
PC4SF11YTZBF		200 V lines, reinforced isolation, repetitive peak-OFF-state voltage	○	○	○*2					7

For the notes *1 to *6, see next page.

The model marked with ▲ may not be available in the near future. Contact with SHARP for details before use.

Notice

In the absence of confirmation by device specification sheets, SHARP takes no responsibility for any defects that may occur in equipment using any SHARP devices shown in catalogs, data books, etc.
 Except where specially indicated, models listed on this page comply with the RoHS Directive*. For details, please contact SHARP.
 *RoHS Directive: Prohibits use of lead, cadmium, hexavalent chromium, mercury and specific brominated flame retardants (PBBs and PBDEs), with certain exceptions.
 Contact SHARP in order to obtain the latest device specification sheets before using any SHARP device.



Phototriac Couplers (Built-in zero-cross circuit type)

○: Approved

(Ta = 25°C)

Model No.	Internal connection diagram	Features	Approved by safety standards*4			Package	Absolute maximum ratings			Electro-optical characteristics
			UL, CSA	VDE	Others		ON-state current I _T (rms) (A)	Repetitive peak OFF-state V _{DRM} (V)	Isolation voltage (AC) V _{iso} (rms) (kV)	
S2S4A00F		200 V lines, compact	○	○*6	–	Mini-flat 4-pin	0.05	600	3.75	10*5
PC3SH21YFZBX		200 V lines, compact, reinforced isolation	○	○	○*2	4-pin DIP	0.1	600	5.0	7
PC3SD21NTZAF		200 V lines, low zero-cross voltage: MAX. 20 V	○	○*6	–	6-pin DIP*1,3	0.1	600	5.0	10
PC3SD21NTZBF		200 V lines, low zero-cross voltage: MAX. 20 V	○	○*6	–					7
PC3SD21NTZDF		200 V lines, low zero-cross voltage: MAX. 20 V	○	○*6	–					3
PC4SD21NTZCF		200 V lines, repetitive peak-OFF-state voltage	○	○*6	–					5
PC4SD21NTZDF		200 V lines, repetitive peak-OFF-state voltage	○	○*6	–					3
PC3SF21YVZAF		200 V lines, reinforced isolation	○	○	○*2					10
PC3SF21YVZBF		200 V lines, reinforced isolation	○	○	○*2					7
PC4SF21YVZBF		200 V lines, reinforced isolation, repetitive peak-OFF-state voltage	○	○	○*2					7
PC4SF21YWPSF		High impulse noise product	○	○	○*2					6-pin DIP*3

*1 Lead forming type for surface mounting is also available.
 *2 In conformance with BSI, SEMKO, DEMKO, and FIMKO
 *3 These are molded pin No. 5.
 *4 Please refer to Specification Sheets for model numbers approved by safety standards.
 *5 V_D = 6 V, R_L = 100Ω
 *6 Optionally available

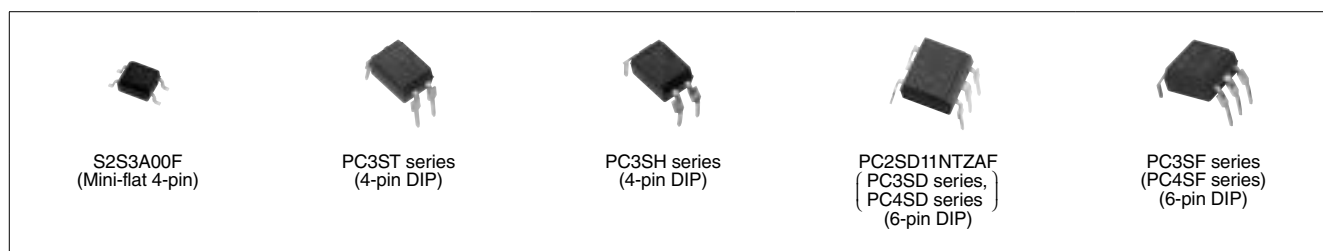



Notice

In the absence of confirmation by device specification sheets, SHARP takes no responsibility for any defects that may occur in equipment using any SHARP devices shown in catalogs, data books, etc.
 Except where specially indicated, models listed on this page comply with the RoHS Directive*. For details, please contact SHARP.
 *RoHS Directive: Prohibits use of lead, cadmium, hexavalent chromium, mercury and specific brominated flame retardants (PBBs and PBDEs), with certain exceptions.
 Contact SHARP in order to obtain the latest device specification sheets before using any SHARP device.



■ Solid State Relay Lineup

Package	Applied voltage	ON-state current (rms)	Features	Model No.	Page
 DIP 6-pin	AC 100 V lines	0.15 A	General purpose	PR22MA11NTZF▲	31
	AC 200 V lines	0.06 A	General purpose	PR31MA11NTZF	31
		0.15 A	General purpose	PR32MA11NTZF	31
 DIP 8-pin	AC 200 V lines	0.3/0.6/0.9/1.2 A	General purpose	PR33MF5 series / PR39MF5 series / PR36MF5 series / PR3BMF5 series / PR36MF12NSZF▲	31
		0.6/0.9/1.2 A	Built-in zero-cross circuit	PR36MF2 series / PR39MF2 series	31

The model marked with ▲ may not be available in the near future. Contact with SHARP for details before use.



■ Solid State Relays

<DIP type>

○: Approved

(Ta = 25°C)

Model No.	Internal connection diagram	Features	Approved by safety standards*1			Package	Absolute maximum ratings			Electrical characteristics Min. trigger current I _{FT} (mA) MAX. V _D = 6 V, R _L = 100Ω	
			UL	CSA	VDE*2		ON-state current I _T (rms) (A)	Repetitive peak OFF-state voltage V _{DRM} (V)	Isolation voltage (AC) V _{ISO} (rms) (kV)		
PR22MA11NTZF▲		100 V lines, 150 mA model in a small package	○	○	○	6-pin DIP	0.15	400	5.0	10	
PR31MA11NTZF		200 V lines, compact	○	○	○		0.06	600		10	
PR32MA11NTZF		200 V lines, 150 mA model in a small package	○	○	○		0.15			10	
PR33MF51NSLF		200 V lines, compact	○	○	○	8-pin DIP	0.3	600	4.0	10	
PR33MF52NSLF		200 V lines, compact	○	○	○					0.6	10
PR36MF51NSLF		200 V lines, compact	○	○	○						0.9
PR36MF12NSZF▲		200 V lines, compact, low input current	○	○	○		1.2				
PR39MF51NSLF		200 V lines, compact	○	○	○					0.6	
PR3BMF51NSLF		200 V lines, compact	○	○	○						600
PR3BMF52NSZF▲		200 V lines, compact, low input current	○	○	○		0.9				
PR36MF21NSZF		200 V lines, compact (built-in zero-cross circuit)	○	○	○					0.6	
PR36MF22NSZF		200 V lines, compact (built-in zero-cross circuit), low input current	○	○	○						600
PR39MF22NSZF	200 V lines, compact (built-in zero-cross circuit), low input current	○	○	○	0.9	5					

*1 Please refer to Specification Sheets for model numbers approved by safety standards.

*2 Optionally available.

The model marked with ▲ may not be available in the near future. Contact with SHARP for details before use.

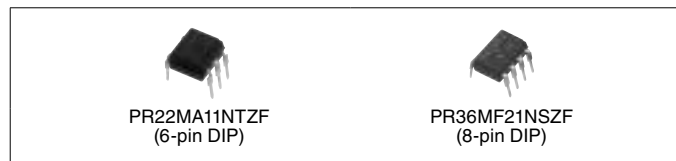

PR22MA11NTZF
(6-pin DIP)

PR36MF21NSZF
(8-pin DIP)

Notice

In the absence of confirmation by device specification sheets, SHARP takes no responsibility for any defects that may occur in equipment using any SHARP devices shown in catalogs, data books, etc.
 Except where specially indicated, models listed on this page comply with the RoHS Directive*. For details, please contact SHARP.
 *RoHS Directive: Prohibits use of lead, cadmium, hexavalent chromium, mercury and specific brominated flame retardants (PBBs and PBDEs), with certain exceptions.
 Contact SHARP in order to obtain the latest device specification sheets before using any SHARP device.



■ Photointerrupter Lineup

<Transmissive type>

Output type	Package type	Outline	Mounting method	Model No. (series)	Page	
Single phototransistor	Compact		PWB mounting type	GP1S396HCP0F / GP1S09xHCZ0F / GP1S19xHCZ0F	33	
			Surface-mount type	GP1S396HCPSF / GP1S296HCPSF / GP1S092HCPIF / GP1S19xHCxSF	33	
	Case type		PWB mounting type	GP1S5x series	34	
			Horizontal slit	PWB mounting type	GP1S59J0000F	34
			General purpose	Snap-in	GP1S173LCS2F / GP1S273LCS1F	34
With connector						
Digital output (OPIC output)	Compact	High resolution	PWB mounting type	★GP1A396HCP0F	35	
	Case type		Surface-mount type	★GP1A396HCPSF	35	
			PWB mounting type	GP1A5x series	35	
	With connector	Wide gap	PWB mounting type	GP1A57HRJ00F	35	
		General purpose	Snap-in	GP1A173LCS3F / GP1A173LCSVF	36	

<Reflective type>

Output type	Package type	Outline	Mounting method	Model No. (series)	Page
Single phototransistor	Leadless	Long focal distance	Surface-mount type	GP2S700HCP	36
High response speed	Compact, thin (leadless)	General purpose	Surface-mount type	GP2S60	36
OPIC output	With connector	Light modulation type, Sensitivity adjusted	Screw mounting type/ Compact snap-in/ Inverter light countermeasures	GP2A25 series / GP2A28 series / GP2A200LCS0F / GP2A230LRS0F / GP2A230LRS0F / ★GP2A430LCSAF / GP2A240LCS0F / GP2A250LCS0F	37

The model marked with ▲ may not be available in the near future. Contact with SHARP for details before use.



■ Photointerrupters

<Transmissive type>

◆ Single Phototransistor Output

<Compact type>

(Ta = 25°C)

Model No.	Internal connection diagram	Features	Detecting and emitting gap (mm)	Slit width (mm)	Electro-optical characteristics						
					Current transfer ratio			Response time			
					CTR (%) MIN.	IF (mA)	VCE (V)	tr (μs) TYP.	IC (mA)	RL (kΩ)	VCE (V)
GP1S092HCPIF		Wide gap, for soldering reflow, surface mount compatible, with positioning boss (4.5 × 2.6 × 2.9 [height] mm)	2.0	0.3	2.0	5	5	50	0.1	1	5
GP1S093HCZ0F		Wide gap (4.5 × 2.6 × 2.9 [height] mm)	2.0	0.3	2.0	5	5	50	0.1	1	5
GP1S094HCZ0F		Wide gap, with positioning pin, (5.5 × 2.6 × 4.8 [height] mm)	3.0	0.3	0.8	5	5	50	0.1	1	5
GP1S194HCZ0F		Compact, wide gap, size: 3.6 × 2.0 × 2.7 (height) mm	1.7	0.3	3.0	5	5	50	0.1	1	5
GP1S195HCPSF		Compact, wide gap, surface mount compatible, size: 3.4 × 2.0 × 2.7 (height) mm	1.5	0.3	3.0	5	5	50	0.1	1	5
GP1S196HCZ0F		Compact, low profile (3.1 × 2.0 × 2.7 [height] mm)	1.1	0.3	2.0	5	5	50	0.1	1	5
GP1S196HCPSF		Surface mount, for soldering reflow, compact, low profile (3.1 × 2.0 × 2.7 [height] mm)	1.1	0.3	2.0	5	5	50	0.1	1	5
GP1S296HCPSF		Surface mount, for soldering reflow, compact, low profile (2.5 × 1.8 × 1.9 [height] mm)	1.0	0.2	3.0	5	5	50	0.1	1	5
GP1S396HCP0F		Straight lead type, compact, low profile (2.26 × 1.4 × 1.6 [height] mm)	1.2	0.12	2.0	5	5	30	0.1	1	5
GP1S396HCPSF		Surface mount, for soldering reflow, compact, low profile (2.26 × 1.4 × 1.6 [height] mm)	1.2	0.12	2.0	5	5	30	0.1	1	5
GP1S097HCZ0F		High resolution, wide gap, with mounting hole (4.5 × 2.6 × 4.5 [height] mm)	2.0	0.3	2.0	5	5	50	0.1	1	5

Note: Topr: -25 to +85°C

GP1SxxxHCZxF: Sleeve package, GP1SxxxHCPxF: Taped package



Notice

In the absence of confirmation by device specification sheets, SHARP takes no responsibility for any defects that may occur in equipment using any SHARP devices shown in catalogs, data books, etc.

Except where specially indicated, models listed on this page comply with the RoHS Directive*. For details, please contact SHARP.
*RoHS Directive: Prohibits use of lead, cadmium, hexavalent chromium, mercury and specific brominated flame retardants (PBBs and PBDEs), with certain exceptions.

Contact SHARP in order to obtain the latest device specification sheets before using any SHARP device.



<Case type>

(Ta = 25°C)

Model No.	Internal connection diagram	Features	Detecting and emitting gap (mm)	Slit width (mm)	Electro-optical characteristics						
					Current transfer ratio			Response time			
					CTR (%) MIN.	IF (mA)	VCE (V)	tr (μs) TYP.	IC (mA)	RL (Ω)	VCE (V)
GP1S50J0000F		High resolution, both-side mounting type	3.0	0.5	2.5	20	5	3	2	100	2
GP1S51VJ000F		High resolution, side mounting type	3.0	0.5	2.5	20	5	3	2	100	2
GP1S52VJ000F		High resolution, PWB mounting type	3.0	0.5	2.5	20	5	3	2	100	2
GP1S53VJ000F		High resolution, PWB mounting type	5.0	0.5	2.5	20	5	3	2	100	2
GP1S56TJ000F▲		High resolution, with positioning pin, PWB mounting type	2.0	0.15	2.0	20	5	38	0.5	1 000	2
GP1S58VJ000F		High resolution, with positioning pin, PWB mounting type	5.0	0.5	2.5	20	5	3	2	100	2
GP1S59J0000F		High resolution, horizontal slit, with positioning pin, PWB mounting type	4.2	0.5	2.5	20	5	3	2	100	2

Note: Topr: -25 to +85°C

The model marked with ▲ may not be available in the near future. Contact with SHARP for details before use.

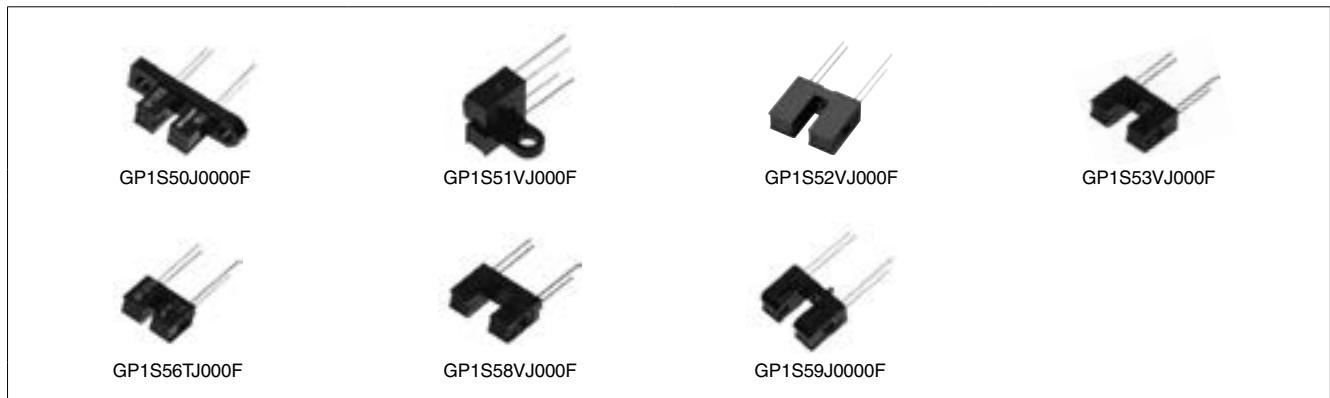

<With connector>

(Ta = 25°C)

Model No.	Internal connection diagram	Features	Detecting and emitting gap (mm)	Slit width (mm)	Electro-optical characteristics						
					Current transfer ratio			Response time			
					CTR (%) MIN.	IF (mA)	VCE (V)	tr (μs) TYP.	IC (mA)	RL (Ω)	VCE (V)
GP1S173LCS2F		Snap-in mounting integrated connector type Applicable to 3 kinds of thickness of mounting boards	5.0	0.5	2.5	20	5	3	2	100	2
GP1S273LCS1F		Snap-in mounting integrated connector type Applicable to 3 kinds of thickness of mounting boards Compact (Compatible with 1.5 mm pitch connector)	5.0	0.7	2.5	20	5	3	2	100	2

Note: Topr: -30 to +95°C

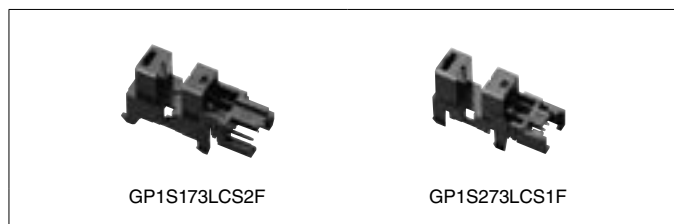

Notice

In the absence of confirmation by device specification sheets, SHARP takes no responsibility for any defects that may occur in equipment using any SHARP devices shown in catalogs, data books, etc.
 Except where specially indicated, models listed on this page comply with the RoHS Directive*. For details, please contact SHARP.
 *RoHS Directive: Prohibits use of lead, cadmium, hexavalent chromium, mercury and specific brominated flame retardants (PBBs and PBDEs), with certain exceptions.
 Contact SHARP in order to obtain the latest device specification sheets before using any SHARP device.

◆OPIC Type ("OPIC" (Optical IC) is a trademark of SHARP Corporation. An OPIC consists of a light-detecting element and signal-processing circuit integrated onto a single chip.)

<Compact type>

(Ta = 25°C)

Model No.	Internal connection diagram	Features	Detecting and emitting gap (mm)	Slit width (mm)	Electro-optical characteristics								
					Threshold input current				Propagation delay time				
					IFLH (mA) MAX.	IFHL (mA) MAX.	VCC (V)	RL (kΩ)	tPLH (μs) TYP.	tPHL (μs) TYP.	IF (mA)	RL (kΩ)	VCC (V)
★GP1A396HCP0F		Compact, high response speed, digital output, PWB mounting	1.2	0.12	2.85	–	2.5 to 5.5	24 to 30	15	15	5	24	3.3
★GP1A396HCP5F		Compact, high response speed, digital output, surface mount	1.2	0.12	2.85	–	2.5 to 5.5	24 to 30	15	15	5	24	3.3

Note: Topr = -25 to +85°C

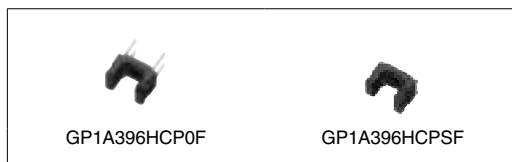

<Case type>

(Ta = 25°C)

Model No.	Internal connection diagram	Features	Detecting and emitting gap (mm)	Slit width (mm)	Electro-optical characteristics							
					Threshold input current			Propagation delay time				
					IFLH (mA) MAX.	IFHL (mA) MAX.	VCC (V)	tPLH (μs) TYP.	tPHL (μs) TYP.	IF (mA)	RL (Ω)	VCC (V)
GP1A50HRJ00F		Both-side mounting, with screw hole	3.0	0.5	5	–	5	3	5	5	280	5
GP1A51HRJ00F		Side mounting, with screw hole	3.0	0.5	5	–	5	3	5	5	280	5
GP1A52HRJ00F		PWB mounting type	3.0	0.5	5	–	5	3	5	5	280	5
GP1A53HRJ00F		PWB mounting type	5.0	0.5	8	–	5	3	5	8	280	5
GP1A57HRJ00F		PWB mounting type, with positioning pin	10.0	1.8	7	–	5	3	5	7	280	5
GP1A58HRJ00F		PWB mounting type, with positioning pin	5.0	0.5	8	–	5	3	5	8	280	5
GP1A52LRJ00F		PWB mounting type	3.0	0.5	–	5	5	5	3	5	280	5

Note: Topr = -25 to +85°C



Notice

In the absence of confirmation by device specification sheets, SHARP takes no responsibility for any defects that may occur in equipment using any SHARP devices shown in catalogs, data books, etc.
 Except where specially indicated, models listed on this page comply with the RoHS Directive*. For details, please contact SHARP.
 *RoHS Directive: Prohibits use of lead, cadmium, hexavalent chromium, mercury and specific brominated flame retardants (PBBs and PBDEs), with certain exceptions.
 Contact SHARP in order to obtain the latest device specification sheets before using any SHARP device.



◆**OPIC Type** (“OPIC” (Optical IC) is a trademark of SHARP Corporation. An OPIC consists of a light-detecting element and signal-processing circuit integrated onto a single chip.)

<With 3-pin connector terminal>

(Ta = 25°C)

Model No.	Internal connection diagram	Features	Detecting and emitting gap (mm)	Slit width (mm)	Electro-optical characteristics					
					Supply voltage V _{CC} (V)		V _{OL} (V) MAX.	Low level output voltage		
					MIN.	MAX.		Light cut-off	I _{oL} (mA)	V _{CC} (V)
GP1A173LCS3F		3 V operation, snap-in mounting integrated connector type ^{*1}	5.0	0.5	2.7	5.5	0.35	No	4	3.3
GP1A173LCSVF		Snap-in mounting integrated connector type ^{*1} , enforced electrostatic discharge (ESD) type	5.0	0.5	4.5	5.5	0.35	No	4	5

Note: Topr: -30 to +95°C

*1 Applicable to 3 kinds of thickness of mounting boards.



■ Photointerrupters

<Reflective type>

◆**Single Phototransistor Output**

<Compact>

(Ta = 25°C)

Model No.	Internal connection diagram	Features	Optimum detecting distance (mm)	Electro-optical characteristics						
				Current transfer ratio			Response time			
				CTR (%) MIN.	I _F (mA)	V _{CE} (V)	t _r (μs) TYP.	I _C (mA)	R _L (kΩ)	V _{CE} (V)
GP2S700HCP		Compact (4 × 3 × 2 [height] mm), long focal distance, surface mounting leadless type	4	1.5	4	2	20	0.1	1	2
GP2S60		Thin (3.2 × 1.7 × 1.1 [height] mm), surface mounting leadless type	1	1.0	4	2	20	0.1	1	2

Note: Topr: -25 to +85°C



Notice

In the absence of confirmation by device specification sheets, SHARP takes no responsibility for any defects that may occur in equipment using any SHARP devices shown in catalogs, data books, etc. Except where specially indicated, models listed on this page comply with the RoHS Directive*. For details, please contact SHARP. *RoHS Directive: Prohibits use of lead, cadmium, hexavalent chromium, mercury and specific brominated flame retardants (PBBs and PBDEs), with certain exceptions.

Contact SHARP in order to obtain the latest device specification sheets before using any SHARP device.

◆ **OPIC Output** (“OPIC” (Optical IC) is a trademark of SHARP Corporation. An OPIC consists of a light-detecting element and signal-processing circuit integrated onto a single chip.)
<With 3-pin connector terminal>

(Ta = 25°C)

Model No.	Internal connection diagram	Features	Optimum detecting distance (mm)	Electro-optical characteristics					
				Supply voltage Vcc (V)		Dissipation current Icc (mA)		Low level output voltage VOL (V)	
				MIN.	MAX.	Vcc (V)	MAX.	Vcc (V)	Vcc (V)
GP2A200LCS0F	(Following diagram [A])	Multiple types of paper detectable, light modulation type, with connector, sensitivity adjusted	5 to 15	4.75	5.25	30*1	5	0.4	5
GP2A240LCS0F		Applicable to inverter fluorescent lamp, light modulation type, with connector, sensitivity adjusted	5 to 15	4.75	5.25	30*1	5	0.4	5
GP2A250LCS0F		Static electricity resistant, applicable to inverter fluorescent lamp, light modulation type, with connector, sensitivity adjusted	2.5 to 12.5	4.75	5.25	30*1	5	0.4	5
GP2A25J0000F	(Following diagram [B])	Multiple types of paper detectable, light modulation type, with connector, sensitivity adjusted	3 to 7	4.75	5.25	30*1	5	0.4	5
GP2A230LRS0F		Compact, screw-clamp type, multiple types of paper detectable, light modulation type, with connector	3 to 7	4.75	5.25	20*1	5	0.4	5
GP2A230LRSAF		Compact, hook type, multiple types of paper detectable, light modulation type, with connector		3.0	5.5	10*1	3.3 to 5	0.4	3.3 to 5
★ GP2A430LCSAF	(Following diagram [C])	Multiple types of paper detectable, light modulation type, with connector, sensitivity adjusted, hook type	3 to 7	4.75	5.25	30*1	5	0.4	5
GP2A25NJ000F	(Following diagram [A])	Multiple types of paper detectable, light modulation type, sensitivity adjusted, improved light-resistance characteristic for inverter lighting, built-in visible light cut filter	3 to 7	4.75	5.25	30*1	5	0.4	5
GP2A25DJ000F		Multiple types of paper detectable, light modulation type, with connector, sensitivity adjusted	3 to 7	4.75	5.25	30*1	5	0.4	5
GP2A28AJ000F		Multiple types of paper detectable, light modulation type, with connector, sensitivity adjusted, hook type	3 to 7	4.75	5.25	30*1	5	0.4	5

Note: Topr: -10 to +60°C (GP2A25J0000F, etc.)
 -10 to +70°C (GP2A200LCS0F, GP2A240LCS0F, GP2A250LCS0F, GP2A230LRS0F, GP2A230LRSAF, GP2A430LCSAF)
 *1 Smoothing value RL = ∞

[Internal connection diagram]

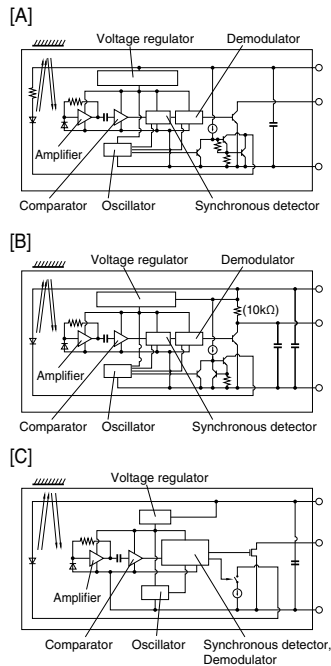

Notice

In the absence of confirmation by device specification sheets, SHARP takes no responsibility for any defects that may occur in equipment using any SHARP devices shown in catalogs, data books, etc.
 Except where specially indicated, models listed on this page comply with the RoHS Directive*. For details, please contact SHARP.
 *RoHS Directive: Prohibits use of lead, cadmium, hexavalent chromium, mercury and specific brominated flame retardants (PBBs and PBDEs), with certain exceptions.
 Contact SHARP in order to obtain the latest device specification sheets before using any SHARP device.

■ Proximity Sensor

(Ta = 25°C)

Model No.	Features	Absolute maximum ratings		Electro-optical characteristics			
		Vcc (V)	Topr (°C)	Dissipation current Icc (μA) TYP.	Detecting distance Lon (mm) MIN.	Non-detecting distance Loff (mm) MAX.	Peak emission wavelength λp (nm)
GP2AP002S30F	Compact size (4.0 × 2.0 × 1.25 t mm) Drastically reduced LED current consumption by employing a light modulation system Built-in LEDs for simple optical design and I ² C output (LED emission duty: MAX. 0.3%)	3.8	-25 to +85	240	25	150	940



■ Proximity Sensor with Integrated Ambient Light Sensor

(Ta = 25°C)

Model No.	Features	Absolute maximum ratings		Electro-optical characteristics					
		Vcc (V)	Topr (°C)	Dissipation current Icc (μA) TYP.	Proximity sensor portion		Ambient light sensor portion		
					Detecting distance Lon (mm) TYP.	Peak emission wavelength λp (nm)	Recommended illuminance range Ev (lx)	Output resolution (bit)	ADC conversion time Tint (ms) TYP.
GP2AP030A00F	LED and ambient light sensor combined in a single package (4.0 × 2.1 × 1.25 t mm) Built-in LEDs for simple optical design Illuminance output: digital 16-bit output (Minimum detectable illuminance: 0.02 lx) I ² C output compatible (proximity sensor, ambient light sensor)	5.5	-35 to +85	65	100	940	0.02 to 10 000	16	100
☆GP2AP007A00F	LED and ambient light sensor combined in a single package (2.5 × 2.0 × 1.0 t mm) Compact with reduced mounting area Illuminance output: digital 16-bit output (Minimum detectable illuminance: 0.1 lx) Small aperture compatible I ² C output compatible (proximity sensor, ambient light sensor)	2.2 to 5.5	-30 to +85	100	100	940	0.1 to 100 000	16	30
☆GP2AP008T00F	LED and ambient light sensor combined in a single package (3.94 × 2.36 × 1.35 t mm) Illuminance output: digital 16-bit output (Minimum detectable illuminance: 0.1 lx) Small aperture compatible I ² C output compatible (proximity sensor, ambient light sensor)	2.2 to 5.5	-30 to +85	100	100	940	0.1 to 100 000	16	30



Notice

In the absence of confirmation by device specification sheets, SHARP takes no responsibility for any defects that may occur in equipment using any SHARP devices shown in catalogs, data books, etc.
 Except where specially indicated, models listed on this page comply with the RoHS Directive*. For details, please contact SHARP.
 *RoHS Directive: Prohibits use of lead, cadmium, hexavalent chromium, mercury and specific brominated flame retardants (PBBs and PBDEs), with certain exceptions.
 Contact SHARP in order to obtain the latest device specification sheets before using any SHARP device.



■ Proximity/Gesture Sensor with Integrated Ambient Light Sensor

(Ta = 25°C)

Model No.	Features	Absolute maximum ratings		Electro-optical characteristics						
		Vcc (V)	Topr (°C)	Dissipation current Icc (μA) TYP.	Dissipation current Icc (Gesture) (μA) TYP.	Proximity/gesture sensor portion		Ambient light sensor portion		
						Detecting distance Lon (mm) TYP.	Peak emission wavelength λp (nm)	Recommended illuminance range Ev (lx)	Output resolution (bit)	ADC conversion time Tint (ms) TYP.
GP2AP054A00F	LED and ambient light sensor combined in a single package (4.0 × 2.1 × 1.25 t mm) Simultaneous operation of the gesture recognition and illuminance functions is possible Low power consumption mode is available for the proximity sensor Capable of holding a total of 4 gesture detection results	5.5	-35 to +85	100	320	100	940	0.02 to 10 000	16	30



■ UV Light Sensors

(Ta = 25°C)

Model No.	Features	Absolute maximum ratings			Electro-optical characteristics					
		Vcc (V)	I ² C voltage VI ² C (V)	Topr (°C)	Dissipation current Icc (μA) TYP.	Built-in clock frequency fosc (MHz) TYP.	Output resolution (bit)	ADC conversion time (ms) TYP.	Recommended illuminance range Ev (lx) Sunlight (AM1.5 equivalent)	
GA1AUV100WP	Detects only UV rays contained within sunlight (no sensitivity to visible light) Built-in ambient light sensor Compact size: 2.0 × 1.6 × 0.6 t mm I ² C output compatible	2.2 to 5.5	1.7 to Vcc	-35 to +85	65	2.62	16	25	UV: 0 to 200 000 Illuminance: 0 to 120 000	



Notice

In the absence of confirmation by device specification sheets, SHARP takes no responsibility for any defects that may occur in equipment using any SHARP devices shown in catalogs, data books, etc.
Except where specially indicated, models listed on this page comply with the RoHS Directive*. For details, please contact SHARP.
*RoHS Directive: Prohibits use of lead, cadmium, hexavalent chromium, mercury and specific brominated flame retardants (PBBs and PBDEs), with certain exceptions.
Contact SHARP in order to obtain the latest device specification sheets before using any SHARP device.



■ OPIC Light Detectors ("OPIC" (Optical IC) is a trademark of SHARP Corporation. An OPIC consists of a light-detecting element and signal-processing circuit integrated onto a single chip.)

(Ta = 25°C)

Model No.	Type	Package	Absolute maximum ratings				Electro-optical characteristics							
			V _{CC} (V)	P (mW)	I _O (mA)	T _{opr} (°C)	EV _{LH} (lx) MAX.	EV _{LH} (lx) MAX.	V _{CC} (V)	t _{PLH} (μs) TYP.	t _{PHL} (μs) TYP.	V _{CC} (V)	E _v (lx)	R _L (Ω)
IS485E	Built-in schmidt trigger circuit, amplifier and voltage regulator	Transparent epoxy resin with condenser (lens)	-0.5 to +17	175	50	-25 to +85	-	35	5	5	3	5	50	280
IS486E			-0.5 to +17	175	50	-25 to +85	35	-	5	3	5	5	50	280



<Model employing a light modulation system>

(Ta = 25°C)

Model No.	Type	Package	Absolute maximum ratings				Electro-optical characteristics*2						External disturbing light illuminance E _{VDX} (lx) TYP.
			V _{CC} (V)	P (mW)	I _O (mA)	T _{opr} (°C)	V _{OL} (V) MAX.	V _{OH} (V) MIN.	t _{PLH} (μs) TYP.	t _{PHL} (μs) TYP.	V _{CC} (V)	R _L (Ω)	
IS471FE*1, *3	Built-in pulse driver circuit at the emitter side, synchronous detector circuit, amplifier circuit and demodulator circuit	Visible light cut-off epoxy resin	-0.5 to +16	250	50	-25 to +60	0.35	4.97	400	400	5	280	7 000

*1 IS471FE is less susceptible to disturbing effects thanks to the light modulation system

*2 V_{CC} = 5 V

*3 Straight lead type (IS471FSE) is also available.



Notice

In the absence of confirmation by device specification sheets, SHARP takes no responsibility for any defects that may occur in equipment using any SHARP devices shown in catalogs, data books, etc.
 Except where specially indicated, models listed on this page comply with the RoHS Directive*. For details, please contact SHARP.
 *RoHS Directive: Prohibits use of lead, cadmium, hexavalent chromium, mercury and specific brominated flame retardants (PBBs and PBDEs), with certain exceptions.
 Contact SHARP in order to obtain the latest device specification sheets before using any SHARP device.



Phototransistor Lineup

Package	Output type	Features	Half sensitivity angle	Model No.	
				Standard	Visible light cut-off
Epoxy resin with lens	Single phototransistor	General purpose/Narrow acceptance	±13°	PT480E0000F	PT480FE0000F
	Darlington phototransistor	Compact, thin	±35°	PT4800E0000F	PT4800FE000F
Surface mounting leadless type	Darlington phototransistor	High sensitivity/Intermediate acceptance	±40°	—	PT491FE0000F
	Single phototransistor	Compact (side view/top view mounting possible)	±15°	PT100MCOMP	PT100MF0MP
	Darlington phototransistor	Compact (side view/top view mounting possible)	±15°	—	PT100MF1MP

Phototransistors

Type	Model No.	Package	Absolute maximum ratings			Ic (mA)				ICEO(A)		Δθ (°) TYP.	λp (nm) TYP.
			VCEO (V)	Pc (mW)	Topr (°C)	MIN.	MAX.	VCE (V)	Ee (mW/cm²)	MAX.	VCE (V)		
Single	PT100MCOMP	Surface mounting leadless type with lens	35	75	-30 to +85	1.7	5.1	5	1	1 × 10 ⁻⁷	20	±15	900
	PT100MF0MP*1		35	75	-30 to +85	1.15	3.45	5	1	1 × 10 ⁻⁷	20	±15	910
	PT480E0000F	Epoxy resin with lens	35	75	-25 to +85	0.4	TYP. 1.7	5	1	1 × 10 ⁻⁷	20	±13	800
	PT480FE0000F*1		35	75	-25 to +85	0.25	TYP. 0.8	5	1	1 × 10 ⁻⁷	20	±13	860
	PT4800E0000F		35	75	-25 to +85	0.12	TYP. 0.4	5	1	1 × 10 ⁻⁷	20	±35	800
	PT4800FE000F*1		35	75	-25 to +85	0.08	TYP. 0.25	5	1	1 × 10 ⁻⁷	20	±35	860
Darlington	PT491FE0000F*1	Epoxy resin with lens	35	75	-25 to +85	0.2	0.8	2	Ev, 2 lx	1 × 10 ⁻⁶	10	±40	860
	PT100MF1MP*1	Surface mounting leadless type with lens	35	75	-30 to +85	0.2	1.2	5	0.01	1 × 10 ⁻⁶	10	±15	860

*1 Visible light cut-off type

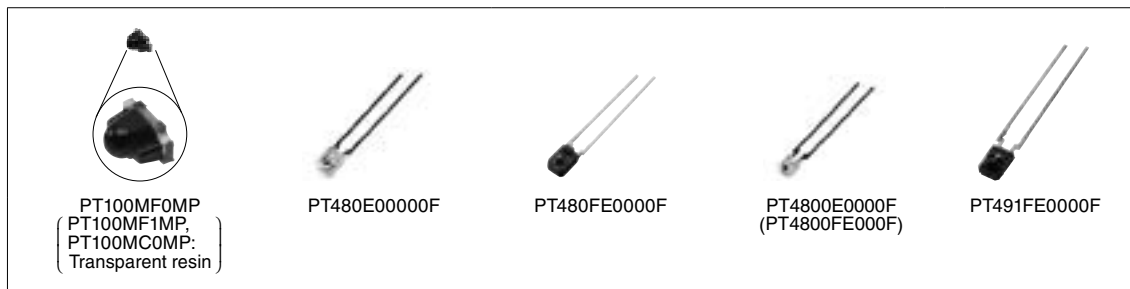

Notice

In the absence of confirmation by device specification sheets, SHARP takes no responsibility for any defects that may occur in equipment using any SHARP devices shown in catalogs, data books, etc.
 Except where specially indicated, models listed on this page comply with the RoHS Directive*. For details, please contact SHARP.
 *RoHS Directive: Prohibits use of lead, cadmium, hexavalent chromium, mercury and specific brominated flame retardants (PBBs and PBDEs), with certain exceptions.
 Contact SHARP in order to obtain the latest device specification sheets before using any SHARP device.



■ PIN Photodiodes

(Ta = 25°C)

Model No.	Features	Package (Material)	Active area (mm ²)	Topr (°C)	Isc (μA) MIN.	Ev (lx)	Id (A) MAX.	VR (V)	tr, tf (μs) TYP.	VR (V)	RL (kΩ)	λp (nm) TYP.
PD410PI2E00F	PIN type	Visible light cut-off epoxy resin with condenser (lens)	3.31	-25 to +85	2.5	100	1 × 10 ⁻⁸	10	0.2	10	1	1 000
PD411PI2E00F		Transparent epoxy resin with condenser (lens)	3.31	-25 to +85	5.0	100	1 × 10 ⁻⁸	10	0.2	10	1	960
PD413PI2E00F	PIN type IrDA1.0	Visible light cut-off epoxy resin with condenser (lens)	3.31	-25 to +85	MIN. 4.5 (TYP. 5.4)	100	1 × 10 ⁻⁸	10	0.2	10	1	960
PD100MC0MP	Surface mounting leadless type	Transparent epoxy resin board with lens	-	-30 to +85	0.6	100	1 × 10 ⁻⁸	10	0.01	15	0.18	820
PD100MF0MP	Surface mounting leadless type	Visible light cut-off epoxy resin board with lens	-	-30 to +85	0.4	100	1 × 10 ⁻⁸	10	0.01	15	0.18	850

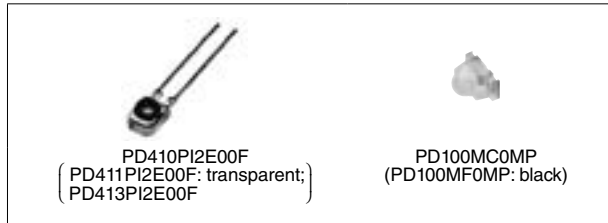

Notice

In the absence of confirmation by device specification sheets, SHARP takes no responsibility for any defects that may occur in equipment using any SHARP devices shown in catalogs, data books, etc.
 Except where specially indicated, models listed on this page comply with the RoHS Directive*. For details, please contact SHARP.
 *RoHS Directive: Prohibits use of lead, cadmium, hexavalent chromium, mercury and specific brominated flame retardants (PBBs and PBDEs), with certain exceptions.
 Contact SHARP in order to obtain the latest device specification sheets before using any SHARP device.



■ Infrared Emitting Diode Lineup

Type	Package	Features	Half intensity angle	Model No.
Single-end lead (Side view type)	Epoxy resin with lens	General purpose/Narrow beam angle	±13°	GL480E00000F
		Compact and thin	±30°	GL4800E0000F
Surface mount type (Mountable for Top view/ Side view type)	Epoxy resin with lens/ leadless	Compact/Narrow beam angle	±10°	GL100MN0MP
		High output type	±10°	GL100MN1MP
		Compact/Wide beam angle	±80°	GL100MD1MP1

■ Infrared Emitting Diodes

(Ta = 25°C)

Model No.	Package, features	Absolute maximum ratings				Radiant flux Φ_e (mW)			VF (V)			$\Delta\theta$ (°) TYP.	λ_p (nm) TYP.
		IF (mA)	VR (V)	P (mW)	Topr (°C)	MIN.	TYP.	IF (mA)	TYP.	MAX.	IF (mA)		
GL480E00000F	Epoxy resin with lens	50	6	75	-25 to +85	0.7	-	20	1.2	1.4	20	±13	950
GL4800E0000F		50	6	75	-25 to +85	0.7	1.6	20	1.2	1.4	20	±30	950
GL100MN0MP	Surface mounting leadless type, epoxy resin board with lens	50	6	75	-30 to +85	1.0	3.0 (MAX.)	20	1.2	1.4	20	±10	940
GL100MN1MP	Surface mounting leadless type, epoxy resin board with lens, high output type	50	6	75	-30 to +85	2.0	6.0 (MAX.)	20	1.2	1.5	20	±10	940
GL100MD1MP1	Surface mounting leadless type, epoxy resin board with lens, wide beam angle	50	6	75	-30 to +85	-	6.0 (MAX.)	20	-	1.5	20	±80	940



Notice

In the absence of confirmation by device specification sheets, SHARP takes no responsibility for any defects that may occur in equipment using any SHARP devices shown in catalogs, data books, etc.
 Except where specially indicated, models listed on this page comply with the RoHS Directive*. For details, please contact SHARP.
 *RoHS Directive: Prohibits use of lead, cadmium, hexavalent chromium, mercury and specific brominated flame retardants (PBBs and PBDEs), with certain exceptions.
 Contact SHARP in order to obtain the latest device specification sheets before using any SHARP device.



Distance Measuring Sensor Lineup

Sensor type	Output	Detected distance	Features	Model No.	
PSD, 2PD	1-bit digital output according to distance measuring	5 cm	Battery drive compatible, compact, 1-bit digital output	GP2Y0D805Z0F	
		10 cm	Battery drive compatible, compact, 1-bit digital output	GP2Y0D810Z0F	
		15 cm	Battery drive compatible, compact, 1-bit digital output	GP2Y0D815Z0F	
		13 cm	1-bit digital output	GP2Y0D413K0F	
		24 cm	1-bit digital output	GP2Y0D21YK0F	
		80 cm	1-bit digital output	GP2Y0D02YK0F	
	Analog voltage output according to distance measuring	1.5 to 15 cm	Analog output	GP2Y0AF15 series	
		2 to 15 cm	Analog output	GP2Y0A51SK0F	
		4 to 30 cm	Analog output	GP2Y0A41SK0F / GP2Y0AF30 series	
		10 to 80 cm	Analog output	GP2Y0A21YK0F	
		10 to 150 cm	Compact (22 × 8 × 7.2 [T] mm), Analog output	GP2Y0A60SZLF	
		20 to 150 cm	Analog output	GP2Y0A02YK0F	
		100 to 550 cm	Analog output	GP2Y0A710K0F	
CMOS	Analog voltage output according to distance measuring (Including I ² C output)	4 to 50 cm	Compact size, high-precision measurement	Analog output	GP2Y0E02A
				I ² C output	GP2Y0E02B
				Analog, I ² C output	GP2Y0E03

Dust Sensor Unit Lineup

Output	Features	Model No.
Analog output	Pulse analog output, single-shot detection of house dust, general purpose	GP2Y1010AU0F
	Pulse analog output, single-shot detection of house dust, high sensitivity	GP2Y1012AU0F
Digital output	Digital (PWM) output, built-in microprocessor controller, single-shot detection of house dust, high sensitivity	GP2Y1023AU0F
	Digital (UART) output, built-in microprocessor controller, sensing can discriminate between PM2.5 and PM10, internal cleaning possible	★GP2Y1030AU0F



Distance Measuring Sensors (1) PSD, 2PD Type

◆ Digital Output

(Ta = 25°C)

Model No.	Detected distance (cm)	Features	Absolute maximum ratings		Electro-optical characteristics*1			
			Vcc (V)	Topr (°C)	VOH (V) MIN.	VOL (V) MAX.	Dissipation current	
							Operating (mA)	Standby (μA)
GP2Y0D805Z0F	5	Light detector, infrared LED and signal processing circuit, short distance measuring type, battery drive compatible (operating power supply: 2.7 to 6.2 V)	-0.3 to +7	-10 to +60	Vcc -0.6	0.6	MAX. 6.5	MAX. 8
GP2Y0D810Z0F	10	Light detector, infrared LED and signal processing circuit, short distance measuring type, battery drive compatible (operating power supply: 2.7 to 6.2 V)	-0.3 to +7	-10 to +60	Vcc -0.6	0.6	MAX. 6.5	MAX. 8
GP2Y0D815Z0F	15	Light detector, infrared LED and signal processing circuit, short distance measuring type, battery drive compatible (operating power supply: 2.7 to 6.2 V)	-0.3 to +7	-10 to +60	Vcc -0.6	0.6	MAX. 6.5	MAX. 8
GP2Y0D413K0F	13	Distance measuring sensor united with PSD*2, infrared LED and signal processing circuit, digital voltage output according to the measured distance	-0.3 to +7	-10 to +60	Vcc -0.3	0.6	-	-
GP2Y0D21YK0F	24	Distance measuring sensor united with PSD*2, infrared LED and signal processing circuit, digital voltage output according to the measured distance	-0.3 to +7	-10 to +60	Vcc -0.3	0.6	MAX. 40	-
GP2Y0D02YK0F	80	Distance measuring sensor united with PSD*2, infrared LED and signal processing circuit, long distance measuring type (No external control signal required), digital voltage output according to the measured distance	-0.3 to +7	-10 to +60	Vcc -0.3	0.6	MAX. 50	-

*1 Vcc = 5 V

*2 PSD: Position Sensitive Detector

Notice

In the absence of confirmation by device specification sheets, SHARP takes no responsibility for any defects that may occur in equipment using any SHARP devices shown in catalogs, data books, etc.

Except where specially indicated, models listed on this page comply with the RoHS Directive*. For details, please contact SHARP.

*RoHS Directive: Prohibits use of lead, cadmium, hexavalent chromium, mercury and specific brominated flame retardants (PBBs and PBDEs), with certain exceptions.

Contact SHARP in order to obtain the latest device specification sheets before using any SHARP device.



Distance Measuring Sensors (1) PSD, 2PD Type

◆ Analog Output

(Ta = 25°C)

Model No.	Distance measuring range (cm)	Features	Absolute maximum ratings		Electro-optical characteristics ^{*1}		
			Vcc (V)	Topr (°C)	VoH (V) MIN.	VoL (V) MAX.	Dissipation current Operating (mA)
GP2Y0AF15 series	1.5 to 15	Distance measuring sensor united with PSD ^{*2} , infrared LED and signal processing circuit, short measuring cycle (16.5 ms), compact, lineup of various connector shapes	-0.3 to +7	-10 to +60	Vo (TYP.) = 0.4 V (at L = 15 cm), ΔVo (TYP.) = 2.3 V (at L = 15 cm → 1.5 cm)		TYP. 17
GP2Y0A51SK0F	2 to 15	Distance measuring sensor united with PSD ^{*2} , infrared LED and signal processing circuit, short measuring cycle (16.5 ms)	-0.3 to +7	-10 to +60	Vo (TYP.) = 0.4 V (at L = 15 cm), ΔVo (TYP.) = 2.25 V (at L = 15 cm → 2 cm)		TYP. 12
GP2Y0AF30 series	4 to 30	Distance measuring sensor united with PSD ^{*2} , infrared LED and signal processing circuit, short measuring cycle (16.5 ms), compact, lineup of various connector shapes	-0.3 to +7	-10 to +60	Vo (TYP.) = 0.4 V (at L = 30 cm), ΔVo (TYP.) = 2.3 V (at L = 30 cm → 4 cm)		TYP. 17
GP2Y0A41SK0F	4 to 30	Distance measuring sensor united with PSD ^{*2} , infrared LED and signal processing circuit, short measuring cycle (16.5 ms)	-0.3 to +7	-10 to +60	Vo (TYP.) = 0.4 V (at L = 30 cm), ΔVo (TYP.) = 2.25 V (at L = 30 cm → 4 cm)		MAX. 22
GP2Y0A21YK0F	10 to 80	Distance measuring sensor united with PSD ^{*2} , infrared LED and signal processing circuit, linear voltage output	-0.3 to +7	-10 to +60	Vo (TYP.) = 0.4 V (at L = 80 cm), ΔVo (TYP.) = 1.9 V (at L = 80 cm → 10 cm)		MAX. 40
GP2Y0A60SZLF	10 to 150	Distance measuring sensor united with PSD ^{*2} , infrared LED and signal processing circuit, compact type (22 x 8 x 7.2 mm), long distance measuring type (No external control signal required)	-0.3 to +5.5	-10 to +60	Vo (TYP.) = 0.65 V (at L = 150 cm), ΔVo (TYP.) = 3.0 V (at L = 150 cm → 20 cm) ^{*3}		MAX. 50
GP2Y0A02YK0F	20 to 150	Distance measuring sensor united with PSD ^{*2} , infrared LED and signal processing circuit, long distance measuring type (No external control signal required)	-0.3 to +7	-10 to +60	Vo (TYP.) = 0.4 V (at L = 150 cm), ΔVo (TYP.) = 2.05 V (at L = 150 cm → 20 cm)		MAX. 50
GP2Y0A710K0F	100 to 550	Distance measuring sensor united with PSD ^{*2} , infrared LED and signal processing circuit, long distance measuring type (No external control signal required)	-0.3 to +7	-10 to +60	Vo (TYP.) = 2.5 V (at L = 100 cm), ΔVo (TYP.) = 0.7 V (at L = 100 cm → 200 cm)		TYP. 30

*1 Vcc = 5 V

*2 PSD: Position Sensitive Detector

*3 When Vcc = 3 V: Vo (TYP.) = 0.35 V (at L = 150 cm); ΔVo (TYP.) = 1.6 V (at L = 150 cm → 20 cm)

Distance Measuring Sensors (2) CMOS type

◆ Analog Output (Including I²C output)

(Ta = 25°C)

Model No.	Distance measuring range (cm)	Features	Absolute maximum ratings		Electro-optical characteristics ^{*1}		
			Vcc (V)	Topr (°C)	VoH (V) MIN.	VoL (V) MAX.	Dissipation current Operating (mA)
GP2Y0E02A	4 to 50	Infrared LED and CMOS image sensor with built-in signal processing circuit, compact size (18.9 x 8 x 5.2 mm), high-precision measurement, analog output	-0.3 to +3.6	-10 to +60	VOUT (A) 1 = 0.3 to 0.8 V (at L = 50 cm), VOUT (A) 3 = 2.1 to 2.3 V (at L = 4 cm)		MAX. 36
GP2Y0E02B	4 to 50	Infrared LED and CMOS image sensor with built-in signal processing circuit, compact size (18.9 x 8 x 5.2 mm), high-precision measurement, I ² C output	-0.3 to +3.6	-10 to +60	D1 = 45 to 50 cm (at L = 50 cm), D3 = 3 to 5 cm (at L = 4 cm)		MAX. 36
GP2Y0E03	4 to 50	Infrared LED and CMOS image sensor with built-in signal processing circuit, compact size (16.7 x 11 x 5.2 mm), high-precision measurement, analog / I ² C output both compatible	-0.3 to +5.5	-10 to +60	VOUT (A) 1 = 0.3 to 0.8 V, D1 = 45 to 50 cm (at L = 50 cm), VOUT (A) 3 = 2.1 to 2.3 V, D3 = 3 to 5 cm (at L = 4 cm)		MAX. 36

*1 Vcc = 5 V

Notice

In the absence of confirmation by device specification sheets, SHARP takes no responsibility for any defects that may occur in equipment using any SHARP devices shown in catalogs, data books, etc.

Except where specially indicated, models listed on this page comply with the RoHS Directive*. For details, please contact SHARP.
*RoHS Directive: Prohibits use of lead, cadmium, hexavalent chromium, mercury and specific brominated flame retardants (PBBs and PBDEs), with certain exceptions.

Contact SHARP in order to obtain the latest device specification sheets before using any SHARP device.

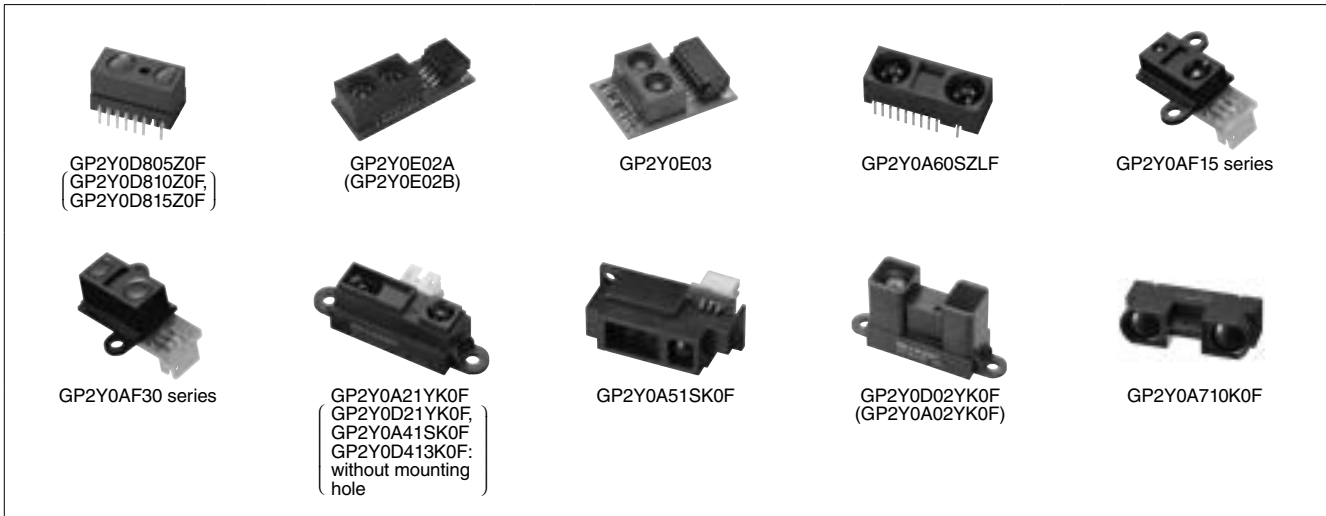

■ Dust Sensor Unit

(Ta = 25°C)

Model No.	Features	Topr (°C)	Operating supply voltage (V)	Electro-optical characteristics		
				Dissipation current (mA)	Detection concentration $\mu\text{g}/\text{m}^3$ (TYP.)	Output
GP2Y1010AU0F	<ul style="list-style-type: none"> Built-in infrared emitting diode, photodiode and signal processing circuit Compact, single-shot detection of house dust Output: Analog voltage 	-10 to +65	4.5 to 5.5	TYP. 11	0 to 600	Analog voltage
GP2Y1012AU0F	<ul style="list-style-type: none"> High sensitivity Built-in infrared emitting diode, photodiode and signal processing circuit Compact, single-shot detection of house dust Output: Analog voltage 		4.5 to 5.5	TYP. 11	0 to 240	Analog voltage
GP2Y1023AU0F	<ul style="list-style-type: none"> High sensitivity Built-in microcomputer Built-in infrared emitting diode, photodiode and signal processing circuit Compact, single-shot detection of house dust Output: Digital signal output (PWM) 		4.75 to 5.25	TYP. 15	0 to 240	Digital signal (PWM) Temperature correction Averaging
★GP2Y1030AU0F	<ul style="list-style-type: none"> Built-in infrared emitting diode, photodiode and signal processing circuit Built-in microcomputer Sensing can discriminate between PM2.5 and PM10 Internal cleaning possible 		3 to 5.5	TYP. 25	0 to 500	Digital signal (UART)

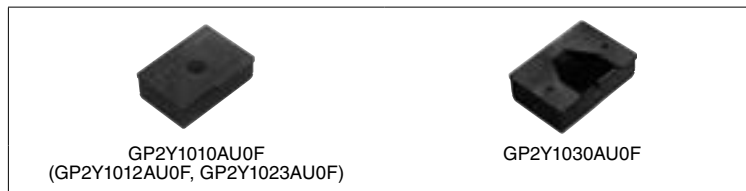

Notice

In the absence of confirmation by device specification sheets, SHARP takes no responsibility for any defects that may occur in equipment using any SHARP devices shown in catalogs, data books, etc.
 Except where specially indicated, models listed on this page comply with the RoHS Directive*. For details, please contact SHARP.
 *RoHS Directive: Prohibits use of lead, cadmium, hexavalent chromium, mercury and specific brominated flame retardants (PBBs and PBDEs), with certain exceptions.
 Contact SHARP in order to obtain the latest device specification sheets before using any SHARP device.



■ IR Detecting Unit for Remote Control Lineup (Classified by Form)

Type	Package		Features	Operating voltage	Model No.		
	Form	Detection position*1 (from PCB)					
IR detecting unit for remote control	Lead L bend with shield case (holder)	16.0 mm*2	Compact size	3 to 5 V	GP1UE28XK0VF series		
			5 V	GP1UM28XK0VF series			
		16.0 mm*2	Compact size, Strengthened resistance to electromagnetic induction noise (Mesh type)	3 to 5 V	GP1UE28RK0VF series		
				5 V	GP1UM28RK0VF series		
		12.0 mm*3	Compact size	3 to 5 V	GP1UE27XK0VF series		
				5 V	GP1UM27XK0VF series		
		12.0 mm*3	Compact size, Strengthened resistance to electromagnetic induction noise (Mesh type)	3 to 5 V	GP1UE27RK0VF series		
				5 V	GP1UM27RK0VF series		
		6.8 mm*4	Compact size	3 to 5 V	GP1UE26XK0VF series		
				5 V	GP1UM26XK0VF series		
	6.8 mm*4		Compact size, Strengthened resistance to electromagnetic induction noise (Mesh type)	3 to 5 V	GP1UE26RK0VF series		
				5 V	GP1UM26RK0VF series		
	Lead straight with shield case (holder)	19.0 mm	Compact size, Strengthened resistance to electromagnetic induction noise (Mesh type)	3 to 5 V	GP1UE29QK0VF series		
				5 V	GP1UM29QK0VF series		
		9.6 mm	Compact size	3 to 5 V	GP1UE28YK0VF series		
				5 V	GP1UM28YK0VF series		
		9.6 mm	Compact size, Strengthened resistance to electromagnetic induction noise (Mesh type)	3 to 5 V	GP1UE28QK0VF series		
				5 V	GP1UM28QK0VF series		
	Holderless	Lead straight 6.0 mm		3 to 5 V	GP1UX31QS series		
				5 V	GP1UX51QS series		
Lead L bend*5 5.3 mm			3 to 5 V	GP1UX31RK series			
			5 V	GP1UX51RK series			

*1 Lead straight: Distance from lens center to mounting board upper surface
 No mesh lead L bend: Distance from tip of lens to mounting board upper surface
 Mesh-type lead L bend: Distance from tip of mesh to mounting board upper surface
 *2 Mesh type (strengthened resistance to electromagnetic induction noise): 16.4 mm
 *3 Mesh type: 12.4 mm *4 Mesh type: 7.2 mm *5 Mesh type: 5.3 mm



■ IR Detecting Units for Remote Control

(Ta = 25°C)

Type	Series No.	Absolute maximum ratings		Operating voltage (V)	Electrical characteristics				Size (mm)	Terminal layout
		Vcc (V)	Topr (°C)		Icc (mA)*1 MAX.	VOH (V) MIN.	VOL (V) MAX.	fo (kHz) TYP.		
With shield case (holder), 5 V drive	GP1UM26XK0VF	0 to 6.0	-10 to +70	4.5 to 5.5	0.6 (0.65)	Vcc-0.5	0.45	*3	5.6 × 9.6 × 6.8	Center Vcc
	GP1UM27XK0VF	0 to 6.0	-10 to +70	4.5 to 5.5	0.6 (0.65)	Vcc-0.5	0.45	*3	5.6 × 9.6 × 12.0	
	GP1UM28XK0VF	0 to 6.0	-10 to +70	4.5 to 5.5	0.6 (0.65)	Vcc-0.5	0.45	*3	5.6 × 9.6 × 16.0	
	GP1UM28YK0VF	0 to 6.0	-10 to +70	4.5 to 5.5	0.6 (0.65)	Vcc-0.5	0.45	*3	5.6 × 8.6 × 12.5(9.6)*2	
With shield case (holder), 5 V drive, Strengthened resistance to electromagnetic induction noise	GP1UM26RK0VF	0 to 6.0	-10 to +70	4.5 to 5.5	0.6 (0.65)	Vcc-0.5	0.45	*3	5.6 × 9.6 × 7.2	
	GP1UM27RK0VF	0 to 6.0	-10 to +70	4.5 to 5.5	0.6 (0.65)	Vcc-0.5	0.45	*3	5.6 × 9.6 × 12.4	
	GP1UM28RK0VF	0 to 6.0	-10 to +70	4.5 to 5.5	0.6 (0.65)	Vcc-0.5	0.45	*3	5.6 × 9.6 × 16.4	
	GP1UM28QK0VF	0 to 6.0	-10 to +70	4.5 to 5.5	0.6 (0.65)	Vcc-0.5	0.45	*3	5.6 × 9.0 × 12.5(9.6)*2	
With shield case (holder), 3 to 5 V drive	GP1UM29QK0VF	0 to 6.0	-10 to +70	4.5 to 5.5	0.6 (0.65)	Vcc-0.5	0.45	*3	5.6 × 16.2 × 21.9(19)*2	
	GP1UE26XK0VF	0 to 6.0	-10 to +70	2.7 to 5.5	0.4	Vcc-0.5	0.45	*3	5.6 × 9.6 × 6.8	
	GP1UE27XK0VF	0 to 6.0	-10 to +70	2.7 to 5.5	0.4	Vcc-0.5	0.45	*3	5.6 × 9.6 × 12.0	
	GP1UE28XK0VF	0 to 6.0	-10 to +70	2.7 to 5.5	0.4	Vcc-0.5	0.45	*3	5.6 × 9.6 × 16.0	
With shield case (holder), 3 to 5 V drive, Strengthened resistance to electromagnetic induction noise	GP1UE28YK0VF	0 to 6.0	-10 to +70	2.7 to 5.5	0.4	Vcc-0.5	0.45	*3	5.6 × 8.6 × 12.5(9.6)*2	
	GP1UE26RK0VF	0 to 6.0	-10 to +70	2.7 to 5.5	0.4	Vcc-0.5	0.45	*3	5.6 × 9.6 × 7.2	
	GP1UE27RK0VF	0 to 6.0	-10 to +70	2.7 to 5.5	0.4	Vcc-0.5	0.45	*3	5.6 × 9.6 × 12.4	
	GP1UE28RK0VF	0 to 6.0	-10 to +70	2.7 to 5.5	0.4	Vcc-0.5	0.45	*3	5.6 × 9.6 × 16.4	
Holderless, 5 V drive, Strengthened resistance to electromagnetic induction noise	GP1UE28QK0VF	0 to 6.0	-10 to +70	2.7 to 5.5	0.4	Vcc-0.5	0.45	*3	5.6 × 9.0 × 12.5(9.6)*2	
	GP1UE29QK0VF	0 to 6.0	-10 to +70	2.7 to 5.5	0.4	Vcc-0.5	0.45	*3	5.6 × 16.2 × 21.9(19)*2	
	GP1UX51QS	0 to 6.0	-10 to +70	4.5 to 5.5	0.6	Vcc-0.5	0.45	*3	5.5 × 5.3 × 7.5	Center GND
	GP1UX51RK	0 to 6.0	-10 to +70	4.5 to 5.5	0.6	Vcc-0.5	0.45	*3	5.5 × 5.3 × 7.5	
Holderless, 3 to 5 V drive, Strengthened resistance to electromagnetic induction noise	GP1UX31QS	0 to 6.0	-10 to +70	4.5 to 5.5	0.4	Vcc-0.5	0.45	*3	5.5 × 5.3 × 7.5	
	GP1UX31RK	0 to 6.0	-10 to +70	4.5 to 5.5	0.4	Vcc-0.5	0.45	*3	5.5 × 5.3 × 7.5	

Note: A voltage regulator circuit is built-in but may be affected by the usage environment. Install with an externally mounted C and R as a power supply filter.

*1 When no signal is input (during input light).

*2 Figures in parentheses indicate the distance to the light detection center.

*3 fo = 32.75/36/36.7/38/40 kHz

Notice

In the absence of confirmation by device specification sheets, SHARP takes no responsibility for any defects that may occur in equipment using any SHARP devices shown in catalogs, data books, etc.
Except where specially indicated, models listed on this page comply with the RoHS Directive*. For details, please contact SHARP.
*RoHS Directive: Prohibits use of lead, cadmium, hexavalent chromium, mercury and specific brominated flame retardants (PBBs and PBDEs), with certain exceptions.
Contact SHARP in order to obtain the latest device specification sheets before using any SHARP device.

Mini ZENIGATA LEDs (ZENIGATA is a registered trademark or a trademark of Sharp Corporation in Japan, the United States and/or other countries.)

<7W class>

(T_J = 90°C)

Outline dimensions (mm)	Model No.	Color temperature (K) TYP.	Forward voltage (V) TYP.	Forward current (mA) TYP.	Total luminous flux (lm) TYP.	Average color rendering index Ra TYP.
15.0 × 12.0 (t = 1.4)	GW6BMG27HD6	2 700	34.5	200	830	83
	GW6BMG30HD6	3 000			885	
	GW6BMG40HD6	4 000			925	
	GW6BGG27HD6	2 700			700	93
	GW6BGG30HD6	3 000			750	

<10W class>

(T_J = 90°C)

Outline dimensions (mm)	Model No.	Color temperature (K) TYP.	Forward voltage (V) TYP.	Forward current (mA) TYP.	Total luminous flux (lm) TYP.	Average color rendering index Ra TYP.
15.0 × 12.0 (t = 1.4)	GW6BMW27HD6	2 700	34.5	300	1 200	83
	GW6BMW30HD6	3 000			1 280	
	GW6BMW40HD6	4 000			1 335	
	GW6BGW27HD6	2 700			1 010	93
	GW6BGW30HD6	3 000			1 085	



Mini ZENIGATA LEDs

<Natural toning type>

(T_J = 25°C)

Outline dimensions (mm)	Model No.	Color temperature (K) TYP.	Forward voltage (V) TYP.	Forward current (mA) TYP.	Total luminous flux (lm) TYP.	Average color rendering index Ra TYP.
15.0 × 12.0 (t = 1.6)	☆GW6NGWJCS0C	2 000	31	50	105	94
		3 000	36.5	350	1 000	92

Mini ZENIGATA LEDs
(Natural toning type)**Notice**

In the absence of confirmation by device specification sheets, SHARP takes no responsibility for any defects that may occur in equipment using any SHARP devices shown in catalogs, data books, etc.

Except where specially indicated, models listed on this page comply with the RoHS Directive*. For details, please contact SHARP.
*RoHS Directive: Prohibits use of lead, cadmium, hexavalent chromium, mercury and specific brominated flame retardants (PBBs and PBDEs), with certain exceptions.

Contact SHARP in order to obtain the latest device specification sheets before using any SHARP device.

■ Mega ZENIGATA LEDs (ZENIGATA is a registered trademark or a trademark of Sharp Corporation in Japan, the United States and/or other countries.)

<17W class>

(T_j = 90°C)

Outline dimensions (mm)	Model No.	Color temperature (K) TYP.	Forward voltage (V) TYP.	Forward current (mA) TYP.	Total luminous flux (lm) TYP.	Average color rendering index Ra TYP.
24.0 × 20.0 (t = 1.45)	☆GW6DMB27BF6	2 700	34.5	500	2 200	83
	☆GW6DMB30BF6	3 000			2 350	
	☆GW6DMB35BF6	3 500			2 425	
	☆GW6DMB40BF6	4 000			2 500	
	☆GW6DGB27BF6	2 700			1 900	93
	☆GW6DGB30BF6	3 000			1 975	
	☆GW6DGB35BF6	3 500			2 050	
	☆GW6DGB40BF6	4 000			2 200	

<25W class>

(T_j = 90°C)

Outline dimensions (mm)	Model No.	Color temperature (K) TYP.	Forward voltage (V) TYP.	Forward current (mA) TYP.	Total luminous flux (lm) TYP.	Average color rendering index Ra TYP.
24.0 × 20.0 (t = 1.45)	☆GW6DMC27BF6	2 700	34.5	700	2 950	83
	☆GW6DMC30BF6	3 000			3 150	
	☆GW6DMC35BF6	3 500			3 250	
	☆GW6DMC40BF6	4 000			3 350	
	☆GW6DGC27BF6	2 700			2 350	93
	☆GW6DGC30BF6	3 000			2 550	
	☆GW6DGC35BF6	3 500			2 750	
	☆GW6DGC40BF6	4 000			2 850	

<35W class>

(T_j = 90°C)

Outline dimensions (mm)	Model No.	Color temperature (K) TYP.	Forward voltage (V) TYP.	Forward current (mA) TYP.	Total luminous flux (lm) TYP.	Average color rendering index Ra TYP.
24.0 × 20.0 (t = 1.45)	☆GW6DMD27BF6	2 700	34.5	950	4 050	83
	☆GW6DMD30BF6	3 000			4 200	
	☆GW6DMD35BF6	3 500			4 350	
	☆GW6DMD40BF6	4 000			4 500	
	☆GW6DGD27BF6	2 700			3 300	93
	☆GW6DGD30BF6	3 000			3 450	
	☆GW6DGD35BF6	3 500			3 600	
	☆GW6DGD40BF6	4 000			3 750	

<45W class>

(T_j = 90°C)

Outline dimensions (mm)	Model No.	Color temperature (K) TYP.	Forward voltage (V) TYP.	Forward current (mA) TYP.	Total luminous flux (lm) TYP.	Average color rendering index Ra TYP.
24.0 × 20.0 (t = 1.45)	☆GW6DME27BF6	2 700	46.1	950	5 150	82
	☆GW6DME30BF6	3 000			5 550	
	☆GW6DME35BF6	3 500			5 750	
	☆GW6DME40BF6	4 000			5 950	
	☆GW6DGE27BF6	2 700			4 350	93
	☆GW6DGE30BF6	3 000			4 750	
	☆GW6DGE35BF6	3 500			4 950	
	☆GW6DGE40BF6	4 000			4 950	



Mega ZENIGATA LEDs

Notice

In the absence of confirmation by device specification sheets, SHARP takes no responsibility for any defects that may occur in equipment using any SHARP devices shown in catalogs, data books, etc.

Except where specially indicated, models listed on this page comply with the RoHS Directive*. For details, please contact SHARP.

*RoHS Directive: Prohibits use of lead, cadmium, hexavalent chromium, mercury and specific brominated flame retardants (PBBs and PBDEs), with certain exceptions.

Contact SHARP in order to obtain the latest device specification sheets before using any SHARP device.

<Natural toning type>

(T_j = 25°C)

Outline dimensions (mm)	Model No.	Color temperature (K) TYP.	Forward voltage (V) TYP.	Forward current (mA) TYP.	Total luminous flux (lm) TYP.	Average color rendering index Ra TYP.
24.0 × 20.0 (t = 1.6)	☆GW6TGBC50C	2 000	30.4	80	155	94
		3 000	35.8	950	2 860	92



Mega ZENIGATA LEDs
(Natural toning type)

■ TIGER ZENI LEDs

(T_j = 25°C)

Outline dimensions (mm)	Model No.	Color temperature (K) TYP.	Forward voltage (V) TYP.	Forward current (mA) TYP.	Total luminous flux (lm) TYP.	Average color rendering index Ra TYP.
24.0 × 20.0 (t = 1.8)	GW6TGCBG40C	2 700	37	700	1 840	96
		5 700	38		2 170	90



TIGER ZENI LEDs

Notice

In the absence of confirmation by device specification sheets, SHARP takes no responsibility for any defects that may occur in equipment using any SHARP devices shown in catalogs, data books, etc.
 Except where specially indicated, models listed on this page comply with the RoHS Directive*. For details, please contact SHARP.
 *RoHS Directive: Prohibits use of lead, cadmium, hexavalent chromium, mercury and specific brominated flame retardants (PBBs and PBDEs), with certain exceptions.
 Contact SHARP in order to obtain the latest device specification sheets before using any SHARP device.



■ LEDs for Large-sized LCD Backlights (High Color Reproduction Models)

(T_c = 25°C)

Outline dimensions (mm)	Model No.	Color coordinates (x, y) TYP.	Forward voltage (V) TYP.	Forward current (mA) TYP.	Total luminous flux (lm) TYP.	Color reproduction
4.2 × 1.4 (t = 0.8)	GM5FV1ZP10A	0.295, 0.275	3.0	80	26	sRGB=120% (CIE1976)*1
3.7 × 3.5 (t = 0.8)	GM5F22BH20A	0.251, 0.210	6.51	160	86	
7.0 × 2.0 (t = 0.85)	GM5FQ0BH20A	0.266, 0.224	6.11	130	76.5	

*1 Evaluated using a general LCD panel. Values may differ depending on specific LCD panel characteristics.



Notice

In the absence of confirmation by device specification sheets, SHARP takes no responsibility for any defects that may occur in equipment using any SHARP devices shown in catalogs, data books, etc.

Except where specially indicated, models listed on this page comply with the RoHS Directive*. For details, please contact SHARP.

*RoHS Directive: Prohibits use of lead, cadmium, hexavalent chromium, mercury and specific brominated flame retardants (PBBs and PBDEs), with certain exceptions.

Contact SHARP in order to obtain the latest device specification sheets before using any SHARP device.

☆ New product
★ Under development



■ Laser Diodes

- ◆ Model Configurations
- Laser diodes lineup

Wavelength (nm)	Absolute maximum ratings (mW) ^{*1}	Oscillation transverse mode ^{*2}	Package				
			 ø5.6 mm Can type	 ø3.8 mm Can type	 ø3.3 mm Can type	 1.8 mm t Frame type	 1.2 mm t Frame type
405 band	20	SM	★GH04020D2AG	-	-	-	-
450 band	80	SM	★GH04580A2G	-	-	-	-
638 band	7 / 10 / 15	SM	-	-	-	-	☆GH163xxxUK series
	30	SM	-	-	-	★GH16330A8C	-
	50	SM	-	-	-	★GH16350A8C	-
	100	SM	-	-	-	★GH1631AA8C	-
	120	SM	-	★GH0631CA5G	-	-	-
	160	SM	-	★GH0631GA5G series	-	-	-
642 band	150	SM	☆GH0631IA2G series	-	-	-	-
			GH0641FA2G series	-	-	-	-
650 band	200	SM	★GH0652AA2G series	-	-	-	-
660 band	10	SM	-	-	GH06510F4A	-	-
	100	SM	GH06P25A2C	-	-	GH16P32C8C	-
750 band	700	MM	★GH0752WA2G	-	-	-	-
785 band	25	SM	GH07825D2K	-	-	-	-
	155	SM	-	-	GH07P28F4C	-	-
2ch	25 × 2	SM	GH3S225D2B	-	-	-	-
830 band	210	SM	☆GH0832BAxx series	-	☆GH0832BA4C	★GH1832BA8C	-
	700	MM	★GH0832WA2G	-	-	-	-
850 band	700	MM	★GH0852WA2G	-	-	-	-
940 band	210	SM	★GH0942BA1K	-	-	★GH1942BA8C	-
	285	MM	☆GH0942IA2CC	-	-	-	-
	500	MM	★GH0942WA2G	-	-	-	-

*1 The absolute maximum ratings are the limits that are not to be exceeded under any condition whatsoever, whether in testing or in actual use. For CW (continuous wave) output.

*2 SM: Single Mode
MM: Multi Mode

• Eye-safe^{*1} laser diodes lineup

Wavelength (nm)	Absolute maximum ratings (A) ^{*2}	Light output TYP. (mW)	Oscillation transverse mode ^{*3}	Package
				 ø5.6 mm Eye-safe type
750 band	1	470 / 450	MM	★GH4757AxTG series
830 band	1	520 / 500	MM	☆GH4837AxTG series
850 band	1	520 / 500	MM	★GH4857AxTG series
940 band	1	370 / 330	MM	★GH4945AxTG series

*1 Laser with improved safety for eyes.

*2 The absolute maximum ratings are the limits that are not to be exceeded under any condition whatsoever, whether in testing or in actual use. For CW (continuous wave) output.

*3 SM: Single Mode
MM: Multi Mode



◆ Specifications

• Laser diodes

(Tc = 25°C)

Model No.	Wave-length (nm)	Absolute maximum ratings* ¹ (mW)	Operating temperature (°C)	Package size	Built-in monitor PD	Terminal connections	Applications	
★GH04020D2AG	405 band	20	tbd to +70	ø5.6 mm CAN	○	1	BD player	
★GH04580A2G	450 band	80	tbd to +70	ø5.6 mm CAN	—	8	Display, etc.	
☆GH163xxxUK series	638 band	7 / 10 / 15	-10 to +50	1.2 mm frame	○	10	Display, etc.	
★GH16330A8C		30						
★GH16350A8C		50						
★GH1631AA8C		100	-10 to +60	1.8 mm frame	—	6		
★GH0631CA5G		120						
★GH0631GA5G series		160	-10 to +60	ø3.8 mm CAN	—	8		
☆GH0631IA2G series		185						-10 to +65
GH0641FA2G series	642 band	155	-10 to +60	ø5.6 mm CAN	—	8	Display, etc.	
★GH0652AA2G series	650 band	200	-10 to +60	ø5.6 mm CAN	—	9	Display, etc.	
GH06510F4A	660 band	10	-10 to +70	ø3.3 mm CAN	○	1	Bar code reader, laser displacement gauge, etc.	
GH16P32C8C		100	-10 to +70	1.8 mm frame	—	6	Various types of sensors, etc.	
GH06P25A2C				ø5.6 mm CAN		3		
★GH0752WA2G	750 band	700	-10 to +70	ø5.6 mm CAN	—	8	Various types of sensors, etc.	
GH07825D2K	785 band	25	-10 to +60	ø5.6 mm CAN	○	4	Printer, copier, MFP	
GH07P28F4C		155	-10 to +70	ø3.3 mm CAN	—	3	Various types of sensors, etc.	
GH3S225D2B		25 × 2	-10 to +60	ø5.6 mm CAN	○	5	Printer, copier, MFP	
☆GH0832BA2C	830 band	210	-10 to +70	ø5.6 mm CAN	—	3	Various types of sensors, etc.	
☆GH0832BA1K			-10 to +70		○	4		
☆GH0832BA2K			-10 to +70	—	3			
☆GH0832BA4C			-10 to +70	ø3.3 mm CAN	—	3		
★GH1832BA8C			-10 to +70	1.8 mm frame	—	6		
★GH0832WA2G			700	-10 to +70	ø5.6 mm CAN	—		8
★GH0852WA2G	850 band	700	-10 to +70	ø5.6 mm CAN	—	8	Various types of sensors, etc.	
★GH0942BA1K	940 band	210	-10 to +70	ø5.6 mm CAN	○	4	Various types of sensors, etc.	
★GH1942BA8C			-10 to +70	1.8 mm frame	—	6		
☆GH0942IA2CC			285	-10 to +65	ø5.6 mm CAN	—		3
★GH0942WA2G			500	-10 to +70		—		8

*1 The absolute maximum ratings are the limits that are not to be exceeded under any condition whatsoever, whether in testing or in actual use. For CW (continuous wave) output.

• Eye-safe*¹ laser diodes

Model No.	Wavelength (nm)	Absolute maximum ratings (A)* ²	Light output TYP. (mW)	Operating temperature (°C)	Package size	Built-in monitor PD	Terminal connections	Applications
★GH4757AxTG series	750 band	1	470 / 450	tbd to +70	ø5.6 mm CAN	—	8	Various types of sensors, etc.
☆GH4837AxTG series	830 band		520 / 500					
★GH4857AxTG series	850 band		520 / 500					
★GH4945AxTG series	940 band		370 / 330					

*1 Laser with improved safety for eyes.

*2 The absolute maximum ratings are the limits that are not to be exceeded under any condition whatsoever, whether in testing or in actual use. For CW (continuous wave) output.

Notice

In the absence of confirmation by device specification sheets, SHARP takes no responsibility for any defects that may occur in equipment using any SHARP devices shown in catalogs, data books, etc.
 Except where specially indicated, models listed on this page comply with the RoHS Directive*. For details, please contact SHARP.
 *RoHS Directive: Prohibits use of lead, cadmium, hexavalent chromium, mercury and specific brominated flame retardants (PBBs and PBDEs), with certain exceptions.
 Contact SHARP in order to obtain the latest device specification sheets before using any SHARP device.



• Terminal Connections

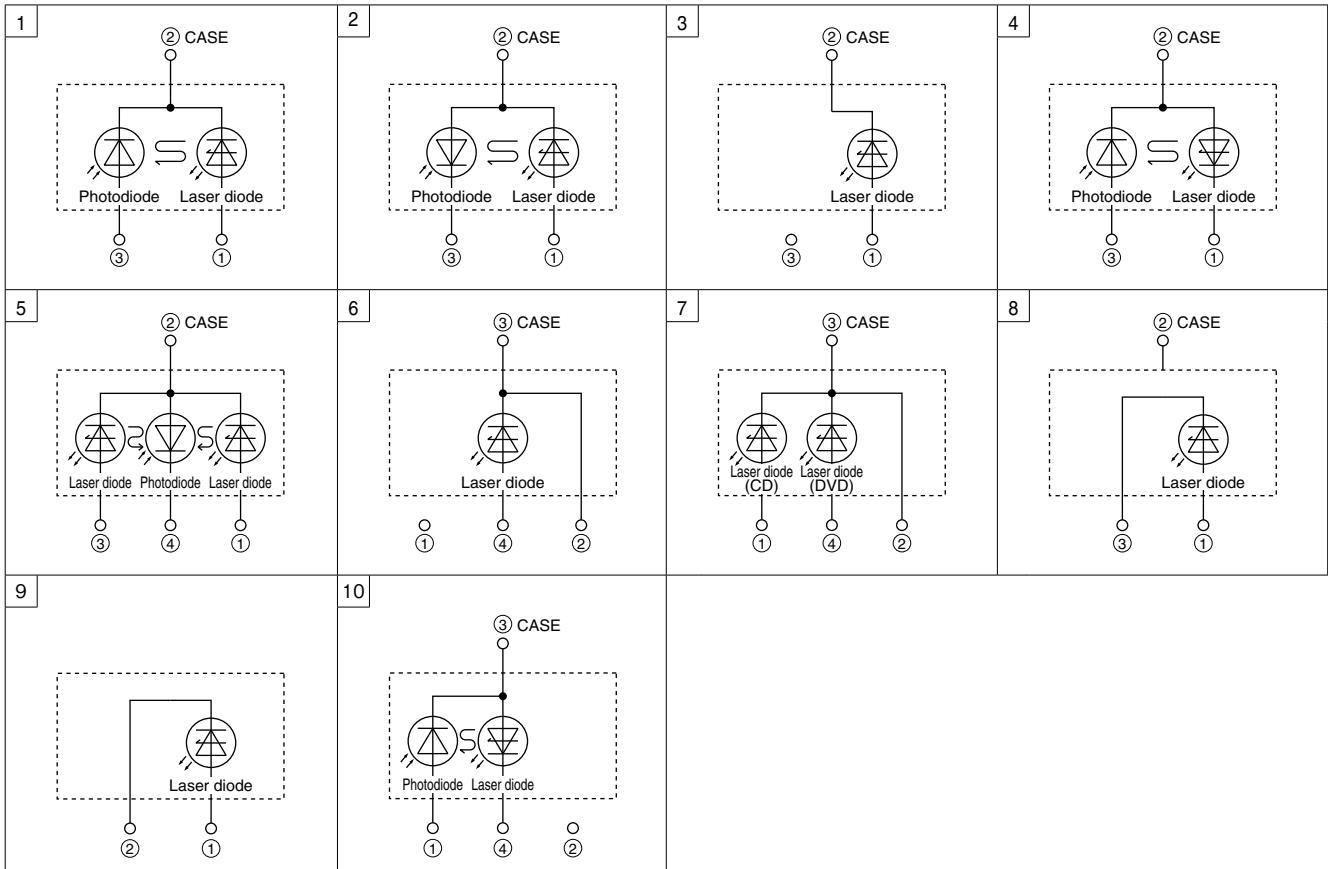

Notice

In the absence of confirmation by device specification sheets, SHARP takes no responsibility for any defects that may occur in equipment using any SHARP devices shown in catalogs, data books, etc.
 Except where specially indicated, models listed on this page comply with the RoHS Directive*. For details, please contact SHARP.
 *RoHS Directive: Prohibits use of lead, cadmium, hexavalent chromium, mercury and specific brominated flame retardants (PBBs and PBDEs), with certain exceptions.
 Contact SHARP in order to obtain the latest device specification sheets before using any SHARP device.

■ Europe: LNBs for Satellite Broadcast

◆ Features

- (1) Wide band type receiving all broadcasting channels (analog & digital) in Europe. [Universal LNB]
- (2) Originally developed feed-horn waveguide makes the wide-band, low-noise characteristics possible.
- (3) One of the industry's most compact and lightweight package.
- (4) Low dissipation current design for energy saving. [95 mA (TYP.): BS1K2EL100A]

◆ Specifications

Destination	Europe, Astra/Eutelsat Satellite etc.			
Receiving polarization	Horizontal/Vertical polarization			
Model No. <Type>	BS1K1EL500A <4-output>	BS1K2EL400A <4-output>	BS1K2EL200A <2-output>	BS1K2EL100A <1-output>
Input frequency (GHz)	10.7 to 11.7 [Low band], 11.7 to 12.75 [High band]			
Output frequency (MHz)	950 to 1 950 [Low band], 1 100 to 2 150 [High band]			
Local oscillation frequency (GHz)	9.75 [Low band], 10.6 [High band]			
NF (dB)	0.4 (TYP.)			0.3 (TYP.)
Conversion gain (dB)	56 (TYP.)		58 (TYP.)	
Phase noise (dBc/Hz)	-55 (TYP.) at 1 kHz		-80 (TYP.) at 1 kHz	
Cross-polar discrimination (dB)	25 (TYP.)			
Supply voltage (V DC) (Polarization switching)	Vertical polarization		11.5 to 14.0 (0/22 kHz)	
	Horizontal polarization		16.0 to 19.0 (0/22 kHz)	
Dissipation current (mA)	200 (TYP.)/250 (MAX.)	135 (TYP.)/300 (MAX.)	200 (TYP.)/250 (MAX.)	95 (TYP.)/120 (MAX.)
Waveguide	Feed-horn (F/D = 0.6)			
Output impedance (Ω)	75			
Output connector (F-type)	4-output (H/H, H/L, V/H, V/L)	4-output (H/V, High and low switching)	2-output (H/V, High and low switching)	1-output (H/V, High and low switching)
Outline dimensions (W) × (D) × (H) (mm)	150 × 70 × 60	159 × 70 × 60	153 × 60 × 60	101 × 60 × 60
Weight (g)	Approx. 190	Approx. 200	Approx. 145	Approx. 75



BS1K1EL500A



BS1K2EL400A



BS1K2EL200A



BS1K2EL100A

Notice

In the absence of confirmation by device specification sheets, SHARP takes no responsibility for any defects that may occur in equipment using any SHARP devices shown in catalogs, data books, etc. Contact SHARP in order to obtain the latest device specification sheets before using any SHARP device.



■ Digital DBS Front-End Units

◆ Features

- (1) Equipped with a high-performance direct conversion IC. Reliability is improved by reducing power consumption and component counts.
- (2) Wide-band reception design also covering CS broadcast band. [Input frequency: 950 to 2 150 MHz]
- (3) User support tools can be provided. [Sample/evaluation boards and software are available.]

◆ Standard Specifications <IQ output type>

Destination	Global (ISDB-S/DVB-S2/ABS-S)	
Input type	1-input/1-loop through output	1-input
Model No.	BS2S7VZ7D03	BS2S7VZ6D02
Input frequency (MHz)	950 to 2 150	
Input signal level (dBm)	-65 to -25	
Base band frequency bandwidth (MHz)	5 to 40, 2 MHz step (BB LPF)	
RF input local leak (dBm)	-68 and below	
Output type	I/Q	
Noise figure (dB)	6 (TYP.)	
Phase noise (dBc/Hz)	-88 (TYP.) at 10 kHz offset	
Supply voltage (V DC)	3.3	
LNB power supply	DC 25 V, 400 mA (MAX.)	
Input impedance (Ω)	75	
Outline dimensions (mm)	30.4 (W) × 29.4 (D) × 12.9 (H)	25.2 (W) × 17.4 (D) × 8.7 (H)

Note: Low-profile type is also available.

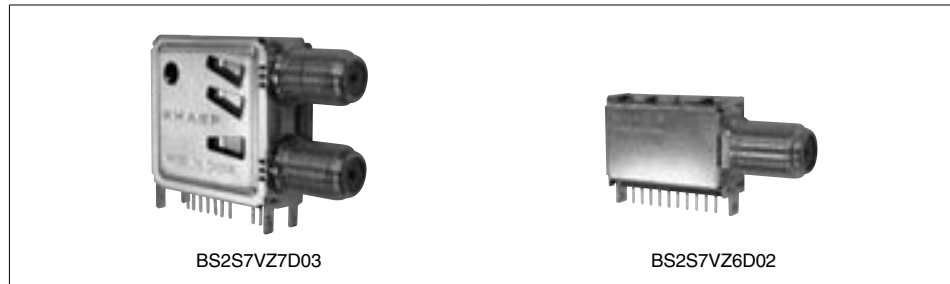

Notice

In the absence of confirmation by device specification sheets, SHARP takes no responsibility for any defects that may occur in equipment using any SHARP devices shown in catalogs, data books, etc. Contact SHARP in order to obtain the latest device specification sheets before using any SHARP device.

■ Front-End Units for ISDB-T/S

◆ Features

- (1) Low phase noise characteristics, high elimination of adjacent channel interference.
- (2) Compact, low power consumption.

◆ Standard Specifications

Destination	Japan (ISDB-T/S)					
Model No.	VA4S5JD2358		VA4S6JD2359		VA4S7JD2371	
	Digital terrestrial	Digital satellite	Digital terrestrial	Digital satellite	Digital terrestrial	Digital satellite
Number of tuners	1	1	2	2	3	3
Input frequency (MHz)	93 to 767	950 to 2 150	93 to 767	950 to 2 150	93 to 767	950 to 2 150
Output type	DIF	I, Q	DIF	I, Q	DIF	I, Q
Noise figure (dB)	4 (TYP.)	5 (TYP.)	4 (TYP.)	5 (TYP.)	4 (TYP.)	5 (TYP.)
Phase noise (dBc/Hz) at 10 kHz offset	-87 (TYP.)	-85 (TYP.)	-87 (TYP.)	-85 (TYP.)	-87 (TYP.)	-85 (TYP.)
Supply voltage (V DC)	1.8, 3.3, 5	3.3	1.8, 3.3, 5	3.3	1.8, 3.3, 5	3.3
Power consumption (W)	0.9	0.7	1.4	1.2	1.9	1.8
Outline dimensions (mm)	41 (W) × 34 (D) × 8.75 (H)					



■ Front-End Units for DVB-T2/DTMB

◆ Features

- (1) Low phase noise characteristics, high elimination of adjacent channel interference.
- (2) Compact, low power consumption.
- (3) Other types are available with various chassis forms (vertical or horizontal type) and input connectors (F or DIN type), etc.

◆ Standard Specifications

Destination	Europe/Asia (DVB-T2), China (DTMB)		
Model No.	VA4M1DX2331	VA4M1DX2323	VA4M2DX2194
Input frequency (MHz)	51 to 868		47 to 868
Output type	DIF	DIF (Off through)	DIF (Dual output)
Noise figure (dB)	5 (TYP.)		
Phase noise (dBc/Hz)	-90		
Supply voltage (V DC)	3.3, 1.8		5, 3.3, 1.8
Power consumption (W)	0.49		1.13
Outline dimensions (mm)	24.2 (W) × 25.8 (D) × 8 (H)		41.3 (W) × 37.5 (D) × 12.3 (H)



Notice

In the absence of confirmation by device specification sheets, SHARP takes no responsibility for any defects that may occur in equipment using any SHARP devices shown in catalogs, data books, etc. Contact SHARP in order to obtain the latest device specification sheets before using any SHARP device.

■ Front-End Units for Digital Terrestrial and Analog Terrestrial Broadcasting

◆ Features

Contributing to the development of thinner LCD TVs and similar products by combining compatibility with digital and analog terrestrial broadcasts into a single unit.

◆ Standard Specifications

Destination	Brazil	China*1
Model No.	VA4M1BC1228	VA4M1CA1309
Input frequency (MHz)	47 to 866	
Output type	IF	
Digital IF bandwidth (MHz)	6	8
Phase noise (dBc/Hz)	-90 (TYP.) at 10 kHz offset	
Supply voltage (V DC)	3.3	
Noise figure (dB)	4 (TYP.)	
Channel selection system	PLL (I ² C-bus)*2	
Outline dimensions (W) × (D) × (H) (mm)	30 × 28 × 7.5	26.2 × 20 × 10.6

*1 Built-in isolator type

*2 I²C-bus is a trademark of Philips Corporation.

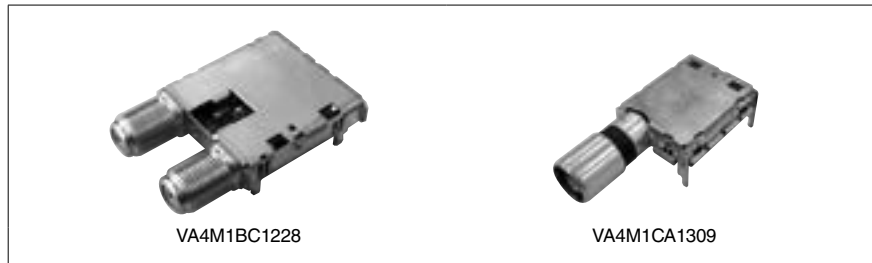

◆ Features

Universal specifications compatible with various broadcasting systems all over the world.

Digital: DVB-T/T2, DVB-C, ATSC, ISDB-T, DTMB

Analog: NTSC-M/N, PAL-B/G/I/DK, SECAM-L, L'

◆ Standard Specifications

Destination	Global
Model No.	VA4M1DB1370
Input frequency (MHz)	47 to 868
Output type	IF
Noise figure (dB)	4 (TYP.)
Phase noise (dBc/Hz)	-90 (TYP.)
Supply voltage (V)	3.3
Outline dimensions (W) × (D) × (H) (mm)	27 × 14 × 7.5



Note: Contact SHARP for custom design product.

(For connector shape or facing side, analog output format, etc.)

Notice

In the absence of confirmation by device specification sheets, SHARP takes no responsibility for any defects that may occur in equipment using any SHARP devices shown in catalogs, data books, etc. Contact SHARP in order to obtain the latest device specification sheets before using any SHARP device.

■ One-Seg Tuner Module

◆ Features

- (1) High sensitivity: -100 dBm (13 seg, QPSK CR: 2/3)
- (2) Compact and thin design: 5.4 × 5.4 × 1.0 mm
- (3) Low power consumption: 41 mW (with software power control)
- (4) Output interface: TS serial output



◆ Standard Specifications

Destination	Japan
Model No.	VA3A5JZ967
Input frequency (MHz)	470 to 770 (UHF: 13 to 62)
Input signal level (dBm)	-100 (13 seg, QPSK CR: 2/3)
Supply voltage (V DC)	1.2 (RF) 1.2 (OFDM Core) 1.62 to 3.6 (I/O)
Power consumption (mW)	41 (TYP.)
Operating temperature range (°C)	-20 to +65
Control I/F	I ² C-bus ^{*1}
Outline dimensions (mm)	5.4 (W) × 5.4 (D) × 1.0 (H)

*1 I²C-bus is a trademark of Philips Corporation.

■ Digital Terrestrial Front-End Unit with EWBS

◆ Features

- (1) Reduced power consumption with use of One-seg broadcasting system
- (2) Compact size for simple assembly



◆ Standard Specifications

Product name	Digital terrestrial front-end unit with EWBS
Destination	Japan/Global (common)
Model No.	VA4M1FB0337
Reception bandwidth (MHz)	6/7/8
Reception frequency range (MHz)	Full-seg tuner: (54 to 864), EWBS: UHF (470 to 862)
Standby power consumption (mW)	Full-seg tuner: 690 (TYP.), EWBS: 63 (TYP.)
Communication system	I ² C
Power supply (V)	Full-seg tuner: 3.3, EWBS: 3.3, 1.2
Outline dimensions (mm)	34 × 40.5 × 7.8

Notice

In the absence of confirmation by device specification sheets, SHARP takes no responsibility for any defects that may occur in equipment using any SHARP devices shown in catalogs, data books, etc. Contact SHARP in order to obtain the latest device specification sheets before using any SHARP device.



■ Non-contact Vital & Motion Sensor Module

◆ Features

- (1) Measures heart and breathing rate without contact using the Doppler effect.
- (2) The module can be embedded in products as sensing is possible through obstructions (except in cases where the obstructions are metal or metal plated).
- (3) Enables stable measurement without being affected by factors such as temperature, direct sunlight, or reflector color.

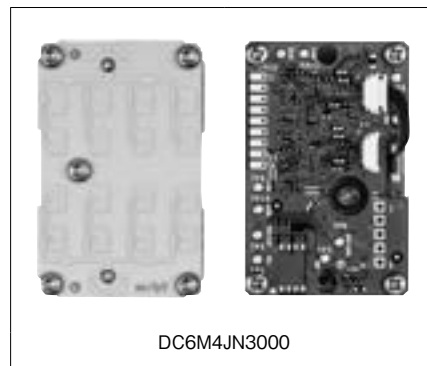

◆ Standard Specifications

Model No.	DC6M4JN3000
Output frequency (GHz)	24.05 to 24.5
Output interface	UART interface (baud rate: 115 200; data bit length: 8 bits)
Applications	Heart rate / Breathing rate / Body motion
Measurable distance (m)	MAX. 1 (heart rate and breathing rate)
Antenna	Planar antenna with 8 patch Tx / Rx antenna elements
Antenna pattern (deg.)	30 (azimuth), 26 (elevation)
Power supply (V)	3.3
Dissipation current (mA)	100 (including signal processing)
Outline dimensions (W)×(D)×(H) (mm)	RF module: 31 × 47.5 × 14.5 Signal processor: 30.0 × 46.5 × 5.0

Notice

In the absence of confirmation by device specification sheets, SHARP takes no responsibility for any defects that may occur in equipment using any SHARP devices shown in catalogs, data books, etc. Contact SHARP in order to obtain the latest device specification sheets before using any SHARP device.



PM2.5 Sensor Module

◆Features

- (1) Easy assembly for use in air purifiers and other products thanks to small size of 53 × 40 × 51 mm
- (2) Industry's shortest*¹ detection time of 10 seconds
- (3) Digital output model is also part of line-up

*¹ As of May 1, 2015 (measured by Sharp)



◆Standard Specifications

Model No.	DN7C3CA007 [Overseas]	DN7C3CD015 [Japan / Overseas]
Measuring range (µg/m ³)	25 to 500	25 to 500
Output type	Analog voltage	Digital PWM
Power supply voltage (Vcc/fan)	DC5 V / DC5 V	DC5 V / DC5 V
Power consumption (mW) (TYP.)	At sensor: 55, At fan: 700 [JA001, CA006] 450 [CA007]	At sensor: 75, At fan: 450
Output voltage range (V)	0 to 3.4 (MIN.)	Vhigh: Vcc-1.5 (MIN.), Vlow: 1.3 (MAX.)
Operating temperature range (°C)	-10 to +60	-10 to +60
Outline dimensions (mm)	53.0 × 40.0 × 51.0 (excluding protruding parts)	53.0 × 40.0 × 51.0 (excluding protruding parts)

Temperature and Humidity Sensor

◆Features

- (1) Package: 3.0 x 3.0 x 0.8 mm, reflowable, QFN
- (2) High-speed response: Approx. 7 sec.*¹
- (3) Interface: I²C

*¹ For 63% of humidity change



◆Standard Specifications

Model No.	QM1H0P0073	
Sensor	Humidity sensor	Temperature sensor
Type	Macromolecule capacity	Semiconductor
Measuring range	0 to 100% RH	-20 to +85°C
Accuracy	±2% RH (25°C)	±0.3°C
Resolution	0.1% RH	0.015°C
Interface	I ² C	

Notice

In the absence of confirmation by device specification sheets, SHARP takes no responsibility for any defects that may occur in equipment using any SHARP devices shown in catalogs, data books, etc. Contact SHARP in order to obtain the latest device specification sheets before using any SHARP device.

BS

BS1K1EL500A.....	57
BS1K2EL100A.....	57
BS1K2EL200A.....	57
BS1K2EL400A.....	57
BS2S7VZ6D02.....	58
BS2S7VZ7D03.....	58

DC

DC6M4JN3000.....	62
------------------	----

DN

DN7C3CA007.....	63
DN7C3CD015.....	63

GA

GA1AUV100WP.....	39
------------------	----

GH

GH04020D2AG.....	54/55
GH04580A2G.....	54/55
GH0631CA5G.....	54/55
GH0631GA5G series.....	54/55
GH0631IA2G series.....	54/55
GH0641FA2G series.....	54/55
GH06510F4A.....	54/55
GH0652AA2G series.....	54/55
GH06P25A2C.....	54/55
GH0752WA2G.....	54/55
GH07825D2K.....	54/55
GH07P28F4C.....	54/55
GH0832BA1K.....	55
GH0832BA2C.....	55
GH0832BA2K.....	55
GH0832BA4C.....	54/55
GH0832BAxx series.....	54
GH0832WA2G.....	54/55
GH0852WA2G.....	54/55
GH0942BA1K.....	54/55

GH0942IA2CC.....	54/55
GH0942WA2G.....	54/55
GH1631AA8C.....	54/55
GH16330A8C.....	54/55
GH16350A8C.....	54/55
GH163xxxUK series.....	54/55
GH16P32C8C.....	54/55
GH1832BA8C.....	54/55
GH1942BA8C.....	54/55
GH3S225D2B.....	54/55
GH4757AxTG series.....	54/55
GH4837AxTG series.....	54/55
GH4857AxTG series.....	54/55
GH4945AxTG series.....	54/55

GL

GL100MD1MP1.....	43
GL100MN0MP.....	43
GL100MN1MP.....	43
GL4800E0000F.....	43
GL480E00000F.....	43

GM5

GM5F22BH20A.....	53
GM5FQ0BH20A.....	53
GM5FV1ZP10A.....	53

GP1

GP1A173LCS3F.....	36
GP1A173LCSVF.....	36
GP1A396HCP0F.....	35
GP1A396HCPSF.....	35
GP1A50HRJ00F.....	35
GP1A51HRJ00F.....	35
GP1A52HRJ00F.....	35
GP1A52LRJ00F.....	35
GP1A53HRJ00F.....	35
GP1A57HRJ00F.....	35
GP1A58HRJ00F.....	35
GP1S092HCPIF.....	33

GP1S093HCZ0F.....	33
GP1S094HCZ0F.....	33
GP1S097HCZ0F.....	33
GP1S173LCS2F.....	34
GP1S194HCZ0F.....	33
GP1S195HCPSF.....	33
GP1S196HCPSF.....	33
GP1S196HCZ0F.....	33
GP1S273LCS1F.....	34
GP1S296HCPSF.....	33
GP1S396HCP0F.....	33
GP1S396HCPSF.....	33
GP1S50J0000F.....	34
GP1S51VJ000F.....	34
GP1S52VJ000F.....	34
GP1S53VJ000F.....	34
GP1S56TJ000F.....	34
GP1S58VJ000F.....	34
GP1S59J0000F.....	34
GP1UE26RK0VF.....	49
GP1UE26XK0VF.....	49
GP1UE27RK0VF.....	49
GP1UE27XK0VF.....	49
GP1UE28QK0VF.....	49
GP1UE28RK0VF.....	49
GP1UE28XK0VF.....	49
GP1UE28YK0VF.....	49
GP1UE29QK0VF.....	49
GP1UM26RK0VF.....	49
GP1UM26XK0VF.....	49
GP1UM27RK0VF.....	49
GP1UM27XK0VF.....	49
GP1UM28QK0VF.....	49
GP1UM28RK0VF.....	49
GP1UM28XK0VF.....	49
GP1UM28YK0VF.....	49
GP1UM29QK0VF.....	49
GP1UX31QS.....	49
GP1UX31RK.....	49
GP1UX51QS.....	49

GP1UX51RK.....	49
----------------	----

GP2	
GP2A200LCS0F.....	37
GP2A230LRS0F.....	37
GP2A230LRSAF.....	37
GP2A240LCS0F.....	37
GP2A250LCS0F.....	37
GP2A25DJ000F.....	37
GP2A25J0000F.....	37
GP2A25NJJ00F.....	37
GP2A28AJ000F.....	37
GP2A430LCSAF.....	37
GP2AP002S30F.....	38
GP2AP007A00F.....	38
GP2AP008T00F.....	38
GP2AP030A00F.....	38
GP2AP054A00F.....	39
GP2S60.....	36
GP2S700HCP.....	36
GP2Y0A02YK0F.....	46
GP2Y0A21YK0F.....	46
GP2Y0A41SK0F.....	46
GP2Y0A51SK0F.....	46
GP2Y0A60SZLF.....	46
GP2Y0A710K0F.....	46
GP2Y0AF15 series.....	46
GP2Y0AF30 series.....	46
GP2Y0D02YK0F.....	45
GP2Y0D21YK0F.....	45
GP2Y0D413K0F.....	45
GP2Y0D805Z0F.....	45
GP2Y0D810Z0F.....	45
GP2Y0D815Z0F.....	45
GP2Y0E02A.....	46
GP2Y0E02B.....	46
GP2Y0E03.....	46
GP2Y1010AU0F.....	47
GP2Y1012AU0F.....	47
GP2Y1023AU0F.....	47

GP2Y1030AU0F.....47	GW6DMD40BF6.....51	LQ085Y3DG18.....2	LQ231U1LW32.....4
	GW6DME27BF6.....51	LQ091B1LW01.....2	LQ270M1LX01.....4
GW6	GW6DME30BF6.....51		
GW6BGG27HD6.....50	GW6DME35BF6.....51	LQ1	LQ3
GW6BGG30HD6.....50	GW6DME40BF6.....51	LQ101K1LY05.....2	LQ315D1JG95.....5
GW6BGW27HD6.....50	GW6NGWJCS0C.....50	LQ101W3LG01.....2	LQ315D1VG01.....5
GW6BGW30HD6.....50	GW6TGBJC50C.....52	LQ104S1DG2C.....2	
GW6BMG27HD6.....50	GW6TGCBG40C.....52	LQ104S1LG81.....2	LQ6
GW6BMG30HD6.....50		LQ104V1DG81.....2	LQ695D1VG03.....5
GW6BMG40HD6.....50	IR	LQ104V1LG81.....2	LQ695D1VG04.....5
GW6BMW27HD6.....50	IR2E58U.....15	LQ121K1LG52.....3	LQ695D3LG03.....5
GW6BMW30HD6.....50	IR2E67M.....15	LQ121K1LG58.....3	LQ695D3LG06.....5
GW6BMW40HD6.....50	IR2E70N.....15	LQ121K1LW56.....3	LQ695D3LG07.....5
GW6DGB27BF6.....51	IR2E71Y.....15	LQ121S1DG81.....3	
GW6DGB30BF6.....51	IR3M92N4.....16	LQ121S1LG84.....3	LQ9
GW6DGB35BF6.....51		LQ121S1LG86.....3	LQ900D3LA01.....5
GW6DGB40BF6.....51	IS	LQ121X3LG02.....3	LQ900D3LA03.....5
GW6DGC27BF6.....51	IS471FE.....40	LQ150X1LG11.....3	
GW6DGC30BF6.....51	IS485E.....40	LQ150X1LG91.....3	LR0
GW6DGC35BF6.....51	IS486E.....40	LQ150X1LG96.....3	LR0G964.....14
GW6DGC40BF6.....51		LQ150X1LW12.....3	LR0G967.....14
GW6DGD27BF6.....51	LK	LQ150X1LW95.....3	LR0G970.....14
GW6DGD30BF6.....51	LK800D3LA28.....5	LQ150X1LW96.....3	LR0G971.....14
GW6DGD35BF6.....51	LK800D3LA38.....5	LQ150X1LX92.....3	
GW6DGD40BF6.....51	LK800D3LA48.....5	LQ150X1LX95.....3	LR3
GW6DGE27BF6.....51		LQ150X1LX96.....3	LR36B16.....11/12
GW6DGE30BF6.....51	LQ0	LQ150X1LX9K.....3	LR388K4.....14
GW6DGE35BF6.....51	LQ035Q3DG03.....2	LQ156M1LG21.....4	
GW6DGE40BF6.....51	LQ035Q3DY01.....2	LQ156M3LW01.....4	LS
GW6DMB27BF6.....51	LQ042T1DW01.....2	LQ156T3LW03.....4	LS010B7DH05.....6
GW6DMB30BF6.....51	LQ043T1DG28.....2	LQ185M3LW01.....4	LS012B7DH02.....6
GW6DMB35BF6.....51	LQ043T1DG29.....2	LQ190E1LW52.....4	LS013B7DH03.....6
GW6DMB40BF6.....51	LQ043Y1DY01.....2	LQ190E1LW72.....4	LS013B7DH05.....6
GW6DMC27BF6.....51	LQ057Q3DC03.....2	LQ190E1LX75.....4	LS013B7DH06.....6
GW6DMC30BF6.....51	LQ064V3DG06.....2	LQ190E1LX75T.....4	LS027B7DH01.....6
GW6DMC35BF6.....51	LQ064X3LW01.....2	LQ190N1LW01.....4	LS037V7DW05.....2
GW6DMC40BF6.....51	LQ070Y3LG01.....2		LS037V7DW06.....2
GW6DMD27BF6.....51	LQ070Y3LW01.....2	LQ2	LS044Q7DH01.....6
GW6DMD30BF6.....51	LQ084S3LG03.....2	LQ201U1LW31.....4	
GW6DMD35BF6.....51	LQ084V1DG43.....2	LQ201U1LW32.....4	

PC1

PC1231xNSZ0X24
 PC123XNNSZ0F24

PC2

PC2SD11NTZAF28

PC3

PC354NJ0000F22
 PC355NJ0000F22
 PC357NJ0000F22
 PC364NJ0000F22
 PC365NJ0000F22
 PC367NJ0000F22
 PC3H3J0000F23
 PC3H41xNIP0F23
 PC3H4J0000F23
 PC3H510NIP0F23
 PC3H5J0000F23
 PC3H71xNIP0F23
 PC3H7J0000F23
 PC3HU7xYIP0B23
 PC3SD11NTZCF28
 PC3SD11YTZCF28
 PC3SD12NTZAF28
 PC3SD13YXZBF28
 PC3SD21NTZAF29
 PC3SD21NTZBF29
 PC3SD21NTZDF29
 PC3SF11YVZAF28
 PC3SF11YVZBF28
 PC3SF21YVZAF29
 PC3SF21YVZBF29
 PC3SH11YFZAF28
 PC3SH13YFZAF28
 PC3SH21YFZBX29
 PC3ST11NSZKF28

PC4

PC400J00000F25
 PC451J00000F22
 PC452J00000F22
 PC457L0NIP0F25
 PC4SD11NTZCF28
 PC4SD21NTZCF29
 PC4SD21NTZDF29
 PC4SF11YTZBF28
 PC4SF21YVZBF29
 PC4SF21YWPSF29

PC8

PC815XNNSZ0F24
 PC8171xNSZ0X24
 PC817XNNSZ0F24
 PC851XNNSZ0F24
 PC852XNNSZ0F24

PC9

PC900V0NSZXF26
 PC925LENSZ0F26

PD

PD100MCOMP42
 PD100MFOMP42
 PD410PI2E00F42
 PD411PI2E00F42
 PD413PI2E00F42

PR

PR22MA11NTZF31
 PR31MA11NTZF31
 PR32MA11NTZF31
 PR33MF51NSLF31
 PR33MF52NSLF31
 PR36MF12NSZF31
 PR36MF21NSZF31
 PR36MF22NSZF31

PR36MF51NSLF31
 PR39MF22NSZF31
 PR39MF51NSLF31
 PR3BMF51NSLF31
 PR3BMF52NSZF31

PT

PT100MCOMP41
 PT100MFOMP41
 PT100MF1MP41
 PT4800E0000F41
 PT4800FE000F41
 PT480E00000F41
 PT480FE0000F41
 PT491FE0000F41

QM

QM1H0P007363

RJ

RJ2315EA0PB10/12
 RJ2315FA0PB10/12
 RJ2325EA0PB10/12
 RJ2325FA0PB10/12
 RJ2331BA0PB10/12
 RJ2331CA0PB10/12
 RJ2341BA0PB10/12
 RJ2341CA0PB10/12
 RJ2355DA0PB10/12
 RJ2355EA0PB10/12
 RJ2365DA0PB10/12
 RJ2365EA0PB10/12
 RJ2411FA0PB10/12
 RJ2421FA0PB10/12
 RJ2431AA0PB10/12
 RJ2441AA0PB10/12
 RJ2455DA0PB10/12
 RJ2465DA0PB10/12
 RJ31N3AA0DT8
 RJ31N3AD0DT8

RJ31N3EA0DT8
 RJ31N3ED0DT8
 RJ31N4AA0DT8
 RJ31N4AD0DT8
 RJ31N4EA0DT8
 RJ31N4ED0DT8
 RJ31P3AA0DT8
 RJ31P3AD0DT8
 RJ31P4AA0DT8
 RJ31P4AD0DT8
 RJ32S3AA0DT9
 RJ32S3AD0DT9
 RJ32S3AF0DT9
 RJ32S4AA0DT9
 RJ32S4AD0DT9
 RJ32S4AF0DT9
 RJ3331AA0PB8
 RJ3341AA0PB8
 RJ33B3AA0DT8
 RJ33B3AD0DT8
 RJ33B4AA0DT8
 RJ33B4AD0DT8
 RJ33J3CA0DT8
 RJ33J4CA0DT8
 RJ33N3AA0LT8
 RJ33N3AD0LT8
 RJ33N4AA0LT8
 RJ33N4AD0LT8
 RJ3DT3AA0DT9
 RJ3DT3AD0DT9
 RJ3DT3AF0DT9
 RJ3DT4AA0DT9
 RJ3DT4AD0DT9
 RJ3DT4AF0DT9
 RJ3DV3AF0DT9
 RJ3DV4AF0DT9
 RJ3EV3EF0DT9
 RJ3EV4EF0DT9
 RJ52N1BA0LT7
 RJ52N2BA0LT7

RJ5DY1BA0LT	7
RJ5DY2BA0LT	7

S2

S2S3A00F	28
S2S4A00F	29
S2S5A00F	28
S2S5FA0F	28

VA

VA3A5JZ967	61
VA4M1BC1228	60
VA4M1CA1309	60
VA4M1DB1370	60
VA4M1DX2323	59
VA4M1DX2331	59
VA4M1FB0337	61
VA4M2DX2194	59
VA4S5JD2358	59
VA4S6JD2359	59
VA4S7JD2371	59

NOTICE

The circuit application examples in this publication are provided to explain representative applications of SHARP devices and are not intended to guarantee any circuit design or license any intellectual property right. SHARP takes no responsibility for any problems related to any intellectual property right of a third party resulting from the use of SHARP devices.

SHARP reserves the right to make changes in the specifications, characteristics, data, materials, structures and other contents described herein at any time without notice in order to improve design or reliability.

Contact SHARP in order to obtain the latest device specification sheets before using any SHARP device. Manufacturing locations are also subject to change without notice.

In the absence of confirmation by device specification sheets, SHARP takes no responsibility for any defects that occur in equipment using any SHARP devices shown in catalogs, data books, etc.

The devices listed in this publication are designed for standard applications for use in general electronic equipment. SHARP's devices shall not be used for or in connection with equipment that requires an extremely high level of reliability, such as military and aerospace applications, telecommunication equipment (trunk lines), nuclear power control equipment and medical or other life support equipment (e.g. Scuba). SHARP takes no responsibility for damage caused by improper use of device, which does not meet the conditions for use specified in the relevant specification sheet.

If the SHARP devices listed in the publication fall within the scope of strategic products described in the Foreign Exchange and Foreign Trade Law of Japan, it is necessary to obtain approval to export such SHARP devices.

This publication is the proprietary product of SHARP and is copyrighted, with all rights reserved. Under the copyright laws, no part of this publication may be reproduced or transmitted in any form or by any means, electronic or mechanical for any purpose, in whole or in part, without the express written permission of SHARP. Express written permission is also required before any use of this publication may be made by a third party.

Contact and consult with a SHARP representative if there are any questions about the contents of this publication.

SHARP CORPORATION

1 TAKUMI-CHO, SAKAI-KU, SAKAI CITY, OSAKA 590-8522, JAPAN

■ Specifications are subject to change without notice.
 ■ All screen images are simulated.

U.S.A.

SHARP MICROELECTRONICS OF THE AMERICAS

■ North American Head Office
 5700 NW Pacific Rim Boulevard
 Camas, WA 98607
 PHONE: +1-360-834-8700 FAX: +1-360-834-8903
 http://www.sharpsma.com

■ Western Region
 1980 Zanker Road San Jose, CA 95112
 PHONE: +1-408-436-4900 FAX: +1-408-436-0924

■ Eastern Region
 285 Billerica Road, Suite 202
 Chelmsford, MA 01824
 PHONE: +1-360-834-8080 FAX: +1-978-256-2237

■ Southern Region
 Braker Pointe, Bldg. #1, 10801 N. Mo-Pac Expy,
 Ste 370, Austin, TX 78759
 PHONE: +1-512-795-9395 FAX: +1-512-795-9685

■ Central Region
 85 W. Algonquin Road, Suite 280
 Arlington Heights, IL 60005
 PHONE: +1-847-258-2750 FAX: +1-847-439-2479
 One Towne Square, Suite 200
 Southfield, MI 48076
 PHONE: +1-248-663-5720 FAX: +1-248-663-5750

EUROPE

SHARP DEVICES EUROPE GmbH

■ Head Office
 Landsberger Strasse 398, 81241 Munich, Germany
 PHONE: +49-89-5468-420 FAX: +49-89-5468-4250
 http://www.sharpsde.com

■ Germany:
Hamburg Office
 Nagelsweg 33-35, 20097 Hamburg, Germany
 PHONE: +49-40-2376-0

■ Italy:
Milan Office
 Vento Direzionale Colleoni Palazzo Taurus Ingresso 2
 20041 Agrate Brianza, Milano, Italy
 PHONE: +39-039-689-9946

■ UK:
European Design Centre
 Edmund Halley Road, Oxford Science Park,
 Oxford, OX4 4GB, United Kingdom
 PHONE: +44-1865-747711

ASIA

SHARP ELECTRONICS (SHANGHAI) CO., LTD. Microelectronics Sales & Marketing Division

15F, King Tower, 28 Xin Jin Qiao Road,
 Pudong DIST, Shanghai 201206 P.R. China
 PHONE: +86-21-58547710
 FAX: +86-21-50304510-8400
 http://ses.sharpmicro.com

■ Beijing Office
 5F, Tower F, Phoenix Place, 5A, Shuguang xili,
 Chaoyang District, Beijing 100028, P.R. China
 PHONE: +86-10-8521-5688 FAX: +86-10-6588-0773

■ Shenzhen Office
 Room AB, 21F, China Economic Trade Building, No.18
 Zizhu 7th Road, Zhuzilin, Shenzhen 518131, P.R. China
 PHONE: +86-755-8826-5236 FAX: +86-21-50304510-8600

SHARP ELECTRONICS (SINGAPORE) PTE., LTD.

18 Ah Hood Road, #09-51
 Hiap Hoe Building at Zhongshan Park
 Singapore 329983
 PHONE: +65-6304-2500 FAX: +65-6304-2599
 http://www.sesl-sharp.com

SHARP ELECTRONIC COMPONENTS (KOREA) CORPORATION

33, Gangnam-Daero 101an-gil, Seocho-Gu,
 Seoul 137-902, Korea
 PHONE: +82-2-711-5813 FAX: +82-2-711-5819

1



2



The following facilities of Sharp Corporation have been certified under the ISO 14001 international standard for environmental management systems. In our products and manufacturing processes, we are actively engaged in environmental preservation efforts.

Facility	Certificate Mark	Certificate No.	Scope of Registered Activities
Advanced Development and Planning Center	1	EC99J2038	Research and development, production technology development, and manufacture of LCD panels
Mie Plant	1	EC99J2051	The manufacture of compact LCD panels
Kameyama Plant	1	EC04J0284	Development, design and manufacture of LCDs
Electronic Components and Devices Company (Fukuyama)	2	JQA-EM7239	Design, development and manufacture of electronic devices
Electronic Components and Devices Company (Mihara)	2	JQA-EM7240	Design, development and manufacture of laser diodes, hologram laser and LED devices



The following groups of Sharp Corporation have been certified under the ISO 9001:2008 international standard for quality management systems.

Certifying organization: Japan Quality Assurance Organization (JQA) [JAB certified]

Group	Certificate No.	Scope of Registered Activities
Electronic Components and Devices Company	JQA-QM8688	The Sales, design/development and manufacturing of the following products. Integrated circuits, RF devices, Opto-electronic devices, module, camera module, application products of camera module, LED, application products of LED, laser diodes, hologram laser
Display Device Company	JQA-QM3776	The design / development and manufacture of Liquid crystal display panel and module

Distributed by

The contents of this catalog are current as of August 2016.



This brochure uses vegetable oil ink.

Ref. No. HT9A26E

SHARP CORP. H1.1 Printed in Japan